



Linear Actuators

THOMSON™
Linear Motion. Optimized.



Linear Motion. Optimized.

Thomson -
Linear Motion. Optimized.

Often the ideal design solution is not about finding the fastest, sturdiest, most accurate or even the least expensive option. Rather, the ideal solution is the optimal balance of performance, life and cost.

Thomson is best positioned to help you most quickly configure the optimal linear motion solution for your application.

- Thomson invented anti-friction linear bearing technology. We own the broadest standard product offering of mechanical motion technologies in the industry.
- Modified versions of standard product are routine. White sheet design solutions available across our entire portfolio.
- Choose Thomson and gain access to over 70 years of global application experience in diverse industries including packaging, factory automation, material handling, medical, clean energy, printing, automotive, machine tool, aerospace and defense.
- As part of Danaher Motion, we are financially strong and unique in our ability to bring together control, drive, motor, power transmission and precision linear motion technologies.

Thomson is the name you can trust for quality, innovation, on-time delivery, controlled costs, and reduced risk.

In addition to the information contained in this document, a wealth of product and application information is available online at www.thomsonlinear.com. Also online are downloadable 3D models, software tools, our distributor locator and global contact information for Thomson. For immediate assistance in North America contact us at 1-540-633-3549 or email us at Thomson@danahermotion.com.

Talk to us early in the design process to see how Thomson can help identify the optimal balance of performance, life and cost for your next application. And, call us or any of our 2000+ distribution partners around the world for fast delivery of replacement parts.

The Danaher Business System - Building sustainable competitive advantage into your business

The Danaher Business System (DBS) was established to increase the value we bring to customers. It is a mature and successful set of tools we use daily to continually improve manufacturing operations and product development processes. DBS is based on the principles of Kaizen which continuously and aggressively eliminate waste in every aspect of our business. DBS focuses the entire organization on achieving breakthrough results that create competitive advantages in quality, delivery and performance – advantages that are passed on to you. Through these advantages Thomson is able to provide you faster times to market as well as unsurpassed product selection, service, reliability and productivity.

Local Support Around the Globe Application Centers Global Manufacturing Operations Global Design & Engineering Centers



Introduction

Table of Contents

Introduction	3	Accessories and Spare Parts	62
Company Introduction.....	4	Mounting Components.....	62 - 64
Product Introduction	5	Electrical Components.....	65 - 66
The Benefits of Electrification	6 - 7	Spare Parts	67
Actuator Applications	8	Ordering Keys	68
Selection Procedure	9	Electrak DC-actuators.....	68 - 72
Performance Overview	10	Electrak AC-actuators.....	73 - 74
Standard Actuator Range.....	10 - 11	Lifting Columns	75
Non-driven and Rotary Actuators	12	Rodless Actuators	76 - 77
Legacy Actuators.....	13	Non-driven Actuators	78
Electrak® Actuators	14	Glossary	80
Electrak 1.....	14 - 15	A - Cu	80
Electrak 1SP.....	16 - 17	Du- Fi	81
Electrak 050.....	18 - 19	Ex - Life	82
Electrak PPA-DC	20 - 21	Lift - Ov.....	83
Electrak 10.....	22 - 23	Po - Si.....	84
Electrak LA14.....	24 - 25	Sp - W	85
Electrak Pro	26 - 27	Application Data Form	86
Electrak 5.....	28 - 29	Worksheet.....	86
Electrak LA24.....	30 - 31	Drawing/notes.....	87
Lifting Columns	32		
TC16.....	32 - 33		
DMD	34 - 35		
DMA	36 - 37		
Rodless Actuators	38		
LM80-H	38 - 39		
LM80-V.....	40 - 41		
LM80-I.....	42 - 43		
Electrak® Non-driven Actuators	44		
Electrak PPA-M.....	44 - 45		
Electrak FA14	46 - 47		
Electrical Wiring Diagrams	48		
DC-actuators	48 - 49		
AC-actuators	50		
Actuator Controls	52		
DPDT Switch.....	53		
AC-063.....	54 - 55		
AC-247 ELS	56 - 57		
Control DCG	58 - 59		
Control Accessories.....	60 - 61		

Introduction

Company Introduction

The history of the Thomson Electrak® actuator goes back to the development of ball screw actuators 40 years ago in Marengo, IL, USA. The first generation of general purpose actuators were developed for control of accessory drives on garden tractors and farm equipment. Since that simple beginning, actuators are now used in all types of equipment to automate a process, remove people from dangerous situations, provide remote control or make difficult, tedious manual jobs easier.

The linear actuators in this catalog represent proven design concepts found in the entire Electrak series. From light load 050s to the high performance Electrak Pro series capable of handling loads up to 9000 N, Thomson offers features unavailable anywhere else.







The world's most versatile actuator selection

Thomson combined the clevis to clevis mount Electrak series, and the trunnion mount Electrak PPA units, to provide the most versatile selection of linear actuators available. Our actuator team has solved over 10000 tough application challenges with even tougher actuators. We

built our reputation in the mobile off highway market in extremely demanding operating conditions. And if you can't find the actuator to meet your application, call us for a cost effective actuator built to your needs. Thomson builds more custom actuators than anyone.

You can count on Thomson

Thomson linear actuators – rugged, reliable remote linear motion control with the push of a button. You can count on Danaher Motion for worldwide sales, service, application support and local availability. Please visit www.thomsonlinear.com for more information.

1967	1969	1974	1982	1984	1987	1988	1991
The first generation of actuators for use in garden tractors and farm equipment is released.	First line of ball screw driven actuators with right angle AC and DC motors is released.	First line of actuators with parallel motors and both acme and ball screw drive is released.	The "Tiger" line actuators are released for OEMs.	Electrak 1, 2, 5, 10 and 100 are released for distribution.	Electrak 205 and the first line of MCS controls are released.	Electrak 1SP with feedback potentiometer is released.	The first lifting columns, DMD and DMA, are released.
							

Introduction

Product Introduction

Thomson actuators are easy to mount and operate, require no maintenance, don't leak hydraulic fluid, are easy to incorporate into an automated process and once installed they will work reliably under the toughest conditions year after year.

Actuators offer advantages over mechanical and hydraulic systems in many applications. They are self-contained, rugged, and durable, making them ideal anywhere you want to lift, lower, push, pull, rotate or position a load.

Compact design

With their compact size, actuators can be located in confined areas. An actuator with a 100 mm stroke length can produce 9000 N of force from a 290 mm package. Electrak 1 and 050 series actuators fit small areas with package lengths as short as 115 mm.

Rugged and reliable

All Thomson actuators incorporate strong, high quality components to assure trouble-free service. Rugged spur, worm or helical gearing, aircraft quality lubricants and high performance motors provide the maximum life and value. The actuators are gasketed and sealed throughout for protection in wet, dirty and oily environments and are ideal for use on outdoor equipment. The rod style actuators have stainless steel or aluminum extension tubes to resist corrosion.

Maintenance-free

All adjustments and lubrication are made at the factory and no maintenance is required or recommended. Consistent,

repeatable performance is provided for the entire lifetime of the actuator.

Bidirectional







Thomson actuators can push and pull loads ranging from one to 900 kg, and can extend up to 900 mm. With the Thomson series of actuator controls, you can create an actuator control system to meet your particular motion control requirements.

Safe operation

Motors used on Electrak actuators utilize thermal switches in their windings or Electronic Load Monitoring to shut the actuator off in case of overheating. A standard overload clutch or Electronic Load Monitoring will stop the motion if the load is too great or at the end of a stroke. All linear actuators will hold their loads with power removed.

Versatile

Stroke lengths of 25 to 1500 mms are available and speeds are as high as 110 mm per second. Actuators are easy to apply, quick to install and usually only requiring two wires for operation. A wide variety of options and controls makes it easy to find the perfect actuator for your application. And if you have special needs, cost effective custom solutions are our speciality.

1992	1994	1998	1999	2000	2004	2006
A patent for a load lock device is granted.	Electrak 1LL is released.	Electrak 150 with two patents is released. AC control line is released.	Electrak 050 with patented design and the first rotary actuators are released.	The first LM80 rodless actuator is released.	The triple profile lifting column TC16 and the "sweeper" actuator are released.	The Electrak Pro actuator line and the DCG control line are released.
						

Introduction

The Benefits of Electrification

Electrification is converting manual, hydraulic and pneumatic operations to electromechanical motion. Substantially improved machine performance and cost advantages can be gained through electrification.

Reduce costs

- Electric actuation components cost less than comparable hydraulic and pneumatic systems.
- One electric linear actuator is faster and easier to install than the multiple hydraulic and pneumatic components required to achieve the same function.
- Electric actuators feature quick and predictable system tuning when compared to the headaches of configuring hydraulic systems and their components which contend with power variation, temperature variation, and non-linear performance profiles.
- Compare zero maintenance electric actuators against the fluid replacement, leak repairs and other routine maintenance needed to support hydraulic systems.
- Eliminate the environmental problems and costs associated with hydraulic fluid leaks and fluid disposal.

Boost productivity and efficiency

- Improve control over critical machine operations with:
 - Multiple digital and analog feedback options
 - Fixed and programmable limit switches for “teach and repeat” positions
 - Low voltage switching options that can interface directly with programmable PC/PLC controllers
 - Pulse width modulation for variable speed control
- Superior accuracy and repeatability
- Link and automate simultaneous processes
- Reduce down time with:
 - Zero maintenance
 - Longer component life
 - Redundancy through manual override
- Improve safety and reduce costs by removing people from danger with convenient remote control

Great opportunities for electric conversion

Making jobs easier

- Raising and lowering a deck on a mower, paver or floor scrubber.
- Shifting manual transmission.
- Lifting wheelchairs into a vehicle.
- Opening and closing doors on buses or vans.

Automating a process

- Moving twine across a round bale of hay for consistent wrap.
- Varying the chute opening on a salt/sand spreader based on speed for consistent application.
- Lift and lower pantographs on electrical trains and trams.

Providing remote control

- Throttle control from the rear of garbage trucks.
- Positioning the discharge spout on a large chipper, snowblower or combine.
- Opening a chute on a salt/sand spreader.
- Positioning of solar energy panels and wind power plant turbines.
- Opening/closing the engine hatch on boats.
- Positioning boat, handicap vehicle seats.
- Belt tensioning.

Removing people from danger

- Sliding a cover over the stairs in a recreational vehicle.
- Throttle control for a tree stump grinder to keep the operator away from moving parts or flying debris.
- Medical waste/refuse compacting.

Replacing hydraulics or pneumatics

- Power steering.
- Dump beds on ATVs.
- Positioning mower decks on golf course equipment.

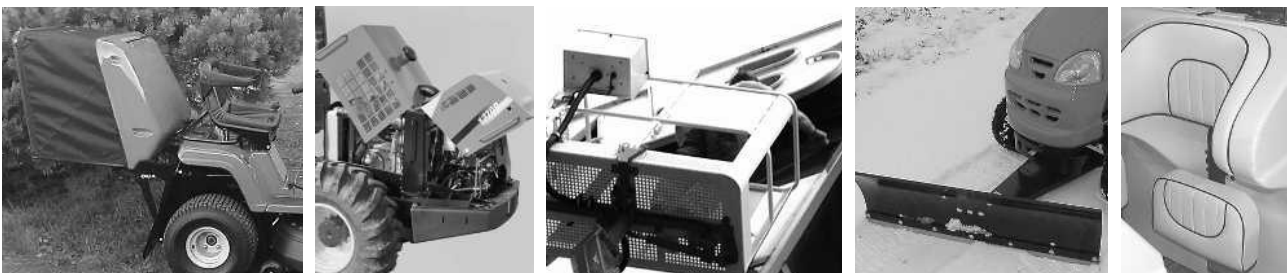

Introduction

The Benefits of Electrification

Replacing hydraulic or pneumatic cylinders with electrical linear actuators means a simpler and smaller installation, easier control, lower energy costs, higher accuracy, less maintenance, less noise and a cleaner, healthier environment.

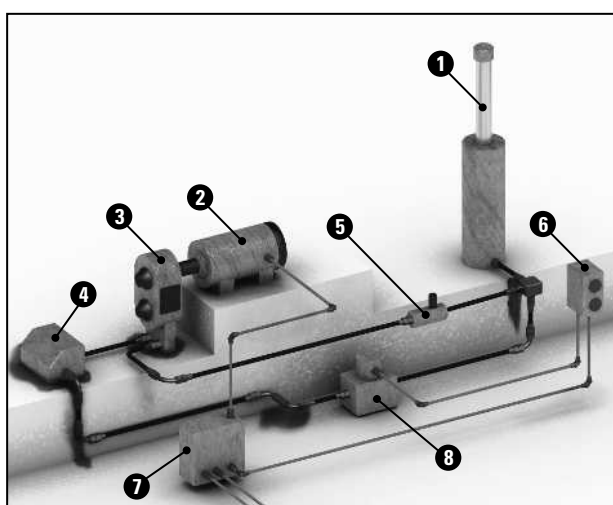

You can design, purchase and install all these components or you can select and install an actuator and control.

Single acting, uni-directional hydraulic cylinder system

1. Hydraulic cylinder
2. Electric pump motor
3. Hydraulic pump
4. Hydraulic oil reservoir
5. Check valve
6. Operator push button box
7. Relay cabinet
8. Unloading valve

This single acting, uni-directional hydraulic cylinder system is one of the simplest hydraulic solutions. This system only allows consistent performance in one direction. In order to get consistent performance in both directions a bi-directional system would be required which is even more complex and costly.

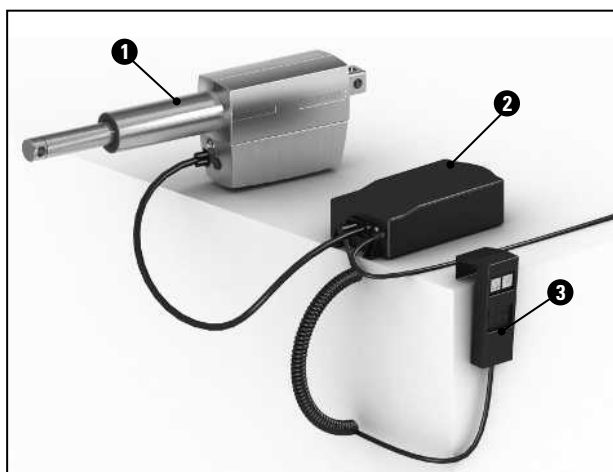

Plug and play type of connections, simple installation and no need for any set up or adjustments ensures accurate, clean and trouble free operation within the hour.

Electric linear actuator system

1. Linear actuator
2. Actuator control
3. Hand held control pendant

This simple electrical actuator system will ensure consistent operation in both directions. It will also give you added features such as electronic load monitoring, end of stroke limit switches, mid stroke protection and manual override operation in case of power failure. Optional features such as analog or digital position feedback, adjustable end of stroke limit switches, end of stroke indication outputs and signal following capability are also available. Another advantage is that a system like this is easy to integrate with other control systems normally found in industrial systems or vehicles such as PLC's, micro-controllers, computers or simple relay based systems.

Introduction

Actuator Applications

Thomson Electrak actuators can be found in the most diverse applications, ranging from agricultural to industrial, ventilation and medical equipment. Anywhere you want to lift, lower, push, pull, rotate or position a load - only your imagination will set the limit.

Mobile-off-highway

Actuators are widely used in agricultural, construction, mining, forestry, road work and railway equipment for the control of seats, hoods, doors, covers, balers, pantographs, sprayer booms, throttles and much more.

Turf and garden

Actuators can be found on riding lawn mowers, golf carts, garden tractors, cleaning machines, sky lifts and other utility vehicles.

Industrial equipment

Actuators are used on conveyor belts, for adjustable work tables/platforms and in the opening and closing of hatches, doors and locks. They are also common in machines for dispensing, cutting, packaging, labeling, scanning or printing.

Health and fitness

Actuators are commonly used in patient lifts/beds, handicap adapted vehicles and wheel chairs to position patients or equipment. Other applications include hospital devices, examination chairs/tables and work out/gym apparatus.

Office, domestic and entertainment equipment

At home, in the office and in the entertainment business actuators are used in automatic doors, lifts, garage doors, gates, satellite dishes, beds, reclining chairs, adjustable office desks, arcade games, vending machines, theatre/TV/ movie props and theme park attractions.

Marine

On boats, ships and oil rigs actuators are used in seats, hatches, fire doors, rescue equipment, valves and throttles.

Ventilation and process control

Actuators are used for valve control in ventilation and process equipment.



Introduction

Selection Procedure

Thomson actuators have been divided into good, better and best groups to help you select the appropriate actuator for your application. By using the simple selection procedure described below and the Performance Overview on the next few pages, the process will be even easier.

Good

These actuators are the lowest cost solution, provide capable, reliable performance and have some flexibility of options and configurations. If you just need a basic actuator, this is the best choice.



Better

These actuators have more flexibility in options, configurations and modifications. They have passed the test of time in the toughest agriculture and construction applications. Choose from this group if you need a rugged, heavy duty actuator customized to your application.



Best

These robust and strong actuators are the market leaders with state of the art technology and flexibility. They are smaller, lighter and have a shorter retracted length than other actuators on the market. If you need electronic load monitoring, programmable limit switches, digital feedback or signal following, this is the group for you.



Selection procedure

Step 1 - Determine Voltage

DC actuators can be operated by battery, a rectifier or an actuator control with 230 Vac input. AC actuators are either 230 or 400 Vac.

Step 2 - Determine Load/Speed

Select the actuator which has the load and speed rating that suits your application.

Step 3 - Select Stroke Length

Choose the desired stroke length from either the Performance Overview pages or the individual product pages.

Step 4 - Verify Design Considerations

Do you need a very short retracted length, adjustable, fixed or programmable limit switches, electronic load monitoring, digital or analog feedback, low voltage power switching, manual override, signal following, clevis mounting, tube mounting or trunnion mounting? If you need an actuator to take side loads or cantilever loads, select from the TC16, DMD, DMA or LM80 actuators.

Step 5 - Select Control

The controls in the catalog are designed for use with Elektrak actuators and range from a simple switch to a control with membrane switches and feedback display or with a hand pendant.

On-line selection software







On www.danahermotion.com/linear_actuator_advisor you can select an actuator by using the actuator product advisor. This easy to use software lets you play with all the parameters and will give you all the relevant data and the correct ordering information for your choice.

Can't find what you are looking for?

If you are an OEM customer and can't find exactly what you need, contact customer service at +46 (0)44 24 67 90 for a custom solution.









Performance Overview

Standard Actuator Range

	ELECTRAK						
	1	1SP	050	PPA-DC	10	LA14	
							
Product availability							
North America / Europe / Asia ¹	•/•/•	•/•/•	•/•/•	•/•/•	•/•/•	/•/•	
General performance							
Product group rating	good	good	better	good	better	best	
Input voltage - Vdc / Vac [V]	12, 24, 36 ² /	12, 24, 36 ² /	12, 24, 36 /	12, 24, 36, 90 ³ /	12, 24, 36 /	12, 24, 36 /	
Maximum dynamic load [N]	340	340	500	6670	6800	6800	
Maximum speed [mm/s]	75	75	48	33	60	60	
Maximum stroke length [mm]	150	150	200	914	610	600	
Restraining torque [Nm]	2,3	0	0	23	12	0	
Protection class	IP65	IP65	IP56	IP52	IP65	IP65	
Features							
Mounting configuration	clevis	clevis	clevis	trunnion	clevis	clevis/trunnion	
Screw type - acme / worm / ball	• / /	• / /	/• /	/ /•	• ² / /•	• / /•	
Overload clutch			•	•	•	•	
Motor overload protection	•	•	•	•	•	•	
End of stroke limit switches	•		•				
Potentiometer feedback		•					
Electronic load monitoring							
Dynamic braking			• ⁷				
Manual override							
Optional features							
End of stroke limit switches				•	• ³		
Potentiometer feedback			•	•	•	•	
Encoder feedback				•			
Programmable limit switches							
End of stroke indication outputs							
Low voltage power switching							
Signal follower input							
External adjustable magnetic sensors						•	
Manual override				• ³	•	•	
More information							
See page ¹	14	16	18	20	22	24	
Actuator Controls							
Recommended control	AC-247 ELS	AC-247 ELS	DCG-150	AC-063	AC-063	AC-063	

¹ Products not available in this region are not further described in this catalog. Contact customer support for more information.

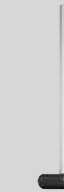

² Not available in North America.

				LIFTING COLUMNS			RODLESS			OTHER
	Pro	5	LA24	TC16	DMD	DMA	LM80-H	LM80-V	LM80-I	
										
	•/•/•	•/•/•	/•/•	•/•/•	•/•/•	•/•/•	•/•/•	•/•/•	•/•/•	<p>On the next pages you can find information on the following type of actuators:</p> <ul style="list-style-type: none"> • Non-driven • Rotary • Legacy • Custom
	best	better	best	best	better	better	better	better	better	
	12, 24 /	/ 115 ³ , 230, 400 ²	/ 230, 400	24 /	12, 24, 36 /	/ 115 ³ , 230, 400 ²	12, 24 /	12, 24 /	12, 24 /	
	9000	6800	6800	2000	6800	6800	2000 ⁴	2000 ⁵	2000 ⁵	
	51	60	60	19	60	60	110	110	110	
	300	610	600	400	610	610	1500	1500	1500	
	17 / 0 ⁶	12	0	0	0	0	0	0	0	
	IP66 (67)	IP45	IP45	IP44	IP65	IP45	IP44	IP44	IP44	
	clevis	clevis	clevis/trunnion	base mount	base mount	base mount	T-slot	T-slot	T-slot	
	• / •	• ² / •	• / •	• ⁸ / /	• / •	• / •	• ⁸ / •	• ⁸ / •		
		•	•		•	•				
		•	•		•	•				
				•						
				•						
		• ³								
		•	•		• ²	• ²				
		•		•						
		•								
		•								
		•								
		•								
		•	•				•	•		
	26	28	30	32	34	36	38	40	42	
	AC-063	DPDT Switch	DPDT Switch	DCG-180	AC-063	DPDT Switch	DCG-170	DCG-160	DCG-180	

³ Not available in Europe. ⁴ For horizontal operation only. ⁵ For vertical operation only. ⁶ Without / with anti-rotation option. ⁷ At end of stroke only. ⁸ Trapezoidal screw.

Performance Overview

Non-driven and Rotary Actuators

	PPA-M	FA14
		
Product availability		
North America / Europe / Asia ¹	•/•/•	/•/•
General performance		
Product group rating	good	best
Max. input torque [Nm]	9	1,8
Max. input speed [rpm]	100	3000
Maximum dynamic load [N]	6670	6800
Maximum speed [mm/s]	8	37
Maximum stroke length [mm]	914	600
Restraining torque [Nm]	23	0
Standard features		
Mounting configuration	trunnion	clevis/trunnion
Screw type - acme / worm / ball	/ / •	• / / •
Overload clutch		•
Optional features		
Manual override		•
Protective bellows	•	
External adjustable magnetic sensors		•
More information		
See page ¹	44	46



¹ Products not available in this region are not further described in this catalog. Contact customer support for more information.

	ROTARY
	DGB
	
Product availability	
North America / Europe / Asia	• / •
General performance	
Product group rating	better
Input voltage - Vdc / Vac [V]	12, 24, 36 /
Maximum torque [Nm]	20
Maximum speed [rpm]	200
Maximum duty cycle [%]	25
Protection class	IP56
Standard features	
Mounting configuration	clevis/tapped holes
Overload clutch	•
Motor overload protection	•
Optional features	
Dual output shafts	•
Manual override	•
More information	
See page ¹	–

¹ Products not available in this region are not further described in this catalog. Contact customer support for more information.

Performance Overview

Legacy Actuators

	ELECTRAK LEGACY ACTUATORS		
	1LL	150	100
			
Product availability			
North America / Europe / Asia	• / /	• / • / •	• / /
General performance			
Product group rating	good	better	better
Input voltage - Vdc / Vac [V]	12, 24 /	12, 24, 36 / 115 ¹	24 /
Maximum dynamic load [N]	340	2000	6800
Maximum speed [mm/s]	76	71	48
Maximum stroke length [mm]	152	406	609
Restraining torque [Nm]	0	0	12
Protection class	IP65	IP56	IP65
Standard features			
Mounting configuration	clevis	clevis	tube
Screw type - acme / worm / ball	• / /	/ • /	/ / •
Overload clutch			
Motor overload protection		•	•
Potentiometer feedback			•
Fixed end of stroke limit switches	•		
Adjustable end of stroke limit switches			•
Internally restrained	•	•	
Optional features			
Adjustable end of stroke limit switches		•	
Potentiometer feedback		•	
Manual override			
External magnetic position sensors			

¹ Not available in Europe.

About Legacy Actuators

The legacy products will not be further described in this catalog. We recommend you choose one of the products on the preceding pages, especially when designing new equipment. However, the legacy actuators can still be purchased and we fully support them. Please contact customer support if you need more information.

About Custom Actuators

The actuators you see on these pages are some of the building blocks we use to create cost effective custom actuators for OEMs. If you can't find the actuator that meets your needs, call customer service at +46 (0) 44 24 67 90 for a custom solution. Thomson is the industry leader in custom actuator design.

Electrak 5

230 and 400 Vac - load up to 6800 N



Standard Features and Benefits

- Robust, strong and reliable
- Stainless steel extension tube
- Acme or ball screw models
- Overload clutch for mid and end of stroke protection
- Heavy duty motor with thermal switch
- Anti-coast brake for repeatable positioning on all ball screw models. Optional on acme screw models.
- Maintenance free

General Specifications

Parameter	Electrak 5
Screw type	acme or ball
Internally restrained	no
Manual override	no, optional
Dynamic braking	no
Holding brake acme screw models ball screw models	no, self-locking yes
End of stroke protection	overload clutch
Mid stroke protection	overload clutch
Motor protection	auto reset thermal switch
Motor connection	cable
Motor connector	no
Certificates	UL, CSA, CE
Options	<ul style="list-style-type: none"> • potentiometer • manual override

» Ordering Key - see page 73

» Glossary - see page 80

» Electric Wiring Diagram - see page 50

Performance Specifications

Parameter	Electrak 5
Maximum load, dynamic / static [N]	
A •• -05A5 (acme screw)*	1100 / 11350
A •• -10A5 (acme screw)	2250 / 11350
A •• -20A5 (acme screw)	2250 / 11350
A •• -05B5 (ball screw)	2250 / 18000
A •• -10B5 (ball screw)	4500 / 18000
A •• -20B5 (ball screw)	4500 / 18000
A •• -21B5 (ball screw)	6800 / 18000
Speed, at no load / at maximum load [mm/s]	
A •• -05A5 (acme screw)*	48 / 38
A •• -10A5 (acme screw)	30 / 18
A •• -20A5 (acme screw)	15 / 12
A •• -05B5 (ball screw)	61 / 37
A •• -10B5 (ball screw)	30 / 19
A •• -20B5 (ball screw)	15 / 12
A •• -21B5 (ball screw)	15 / 11
Available input voltages [Vac]	
Single phase	230**
Three phase	400
Input frequency [Hz]	
1 × 230 Vac model	50/60
3 × 400 Vac model	50
Standard stroke lengths [inch]	4, 6, 8, 10, 12, 14, 16, 18, 20, 24
Operating temperature limits [°C]	-25 – +65
Full load duty cycle @ 25 °C [%]	25
Maximum on time [s]	45
End play, maximum [mm]	1,0
Restraining torque [Nm]	11,3
Lead cross section [mm ²]	1,5
Cable length [mm]	600
Protection class	IP45

* Not possible with 400 Vac input voltage.

** 10 µF capacitor required to run the actuator, p/n 9200-448-003

Compatible Controls

Control model	See page
DPDT switch	53

Electrak 5

230 and 400 Vac - load up to 6800 N

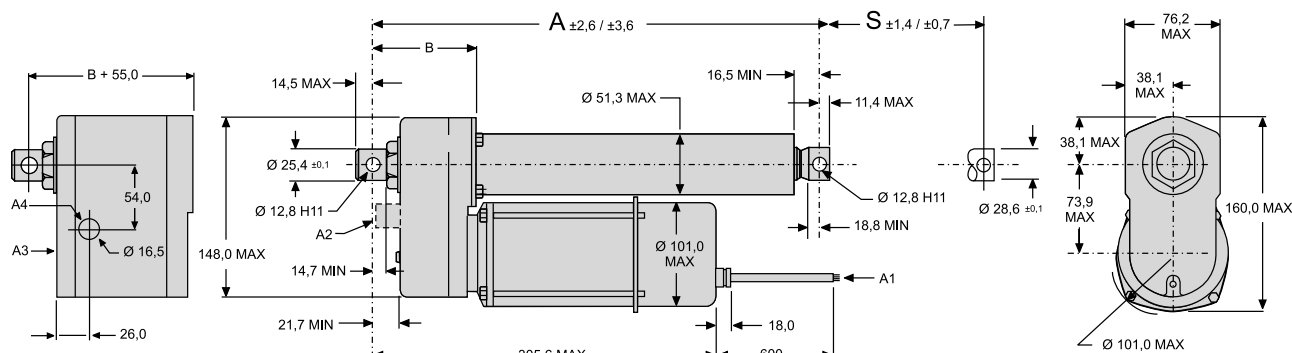

S: stroke, tolerance acme / ball screw
 A: retracted length, tolerance acme / ball screw
 A1: cable
 A2: manual override input (optional)
 A3: housing dimensions for potentiometer option
 A4: potentiometer cable output, cable length = 600 mm

Stroke (S)	[inch (mm)]	4 (101,6)	6 (152,4)	8 (203,2)	10 (254,0)	12 (304,8)	14 (355,6)	16 (406,4)	18 (457,2)	20 (508,0)	24 (609,6)
Retracted length, acme screw models (A)	[mm]	262,3	313,1	363,9	414,7	465,5	567,1	617,9	668,7	719,5	821,1
Retracted length, ball screw models (A)	[mm]	302,3	353,1	403,9	454,7	505,5	607,1	657,9	708,7	759,5	861,1
Add on length for potentiometer*	[mm]	55,0	55,0	55,0	55,0	55,0	55,0	55,0	55,0	55,0	55,0
Weight, acme screw models	[kg]	5,9	6,1	6,3	6,5	6,7	6,9	7,1	7,3	7,5	7,8
Weight, ball screw models	[kg]	6,5	6,7	6,9	7,1	7,3	7,5	7,7	7,9	8,1	8,4
Add on weight for potentiometer*	[kg]	1,3	1,3	1,3	1,3	1,3	1,3	1,3	1,3	1,3	1,3
Potentiometer resistance change*	[ohm/mm]	39	39	39	39	20	20	20	20	20	10

* Potentiometer is optional (NPO, BPO option)

Performance Diagrams

Acme Screw Models
Speed and Current vs. Load

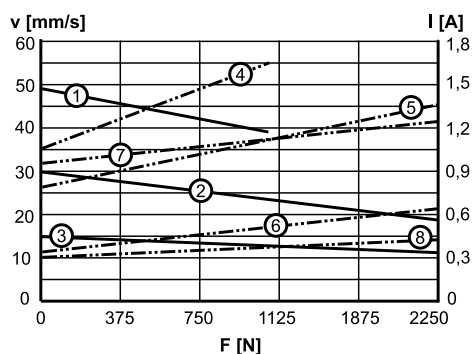

V: speed
 I: current
 F: load
 1: speed A22 -05A5
 2: speed A•• -10A5
 3: speed A•• -20A5
 4: current 230 Vac, A22-05A5
 5: current 230 Vac, A22-10A5
 6: current 400 Vac, A42-10A5
 7: current 230 Vac, A22-20A5
 8: current 400 Vac, A42-20A5

Ball Screw Models
Speed and Current vs. Load

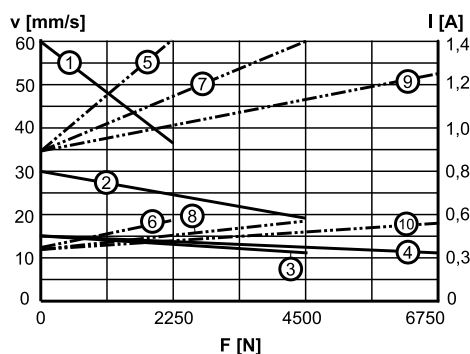

V: speed
 I: current
 F: load
 1: speed A22-05B5, A42-05B5
 2: speed A22-10B5, A42-10B5
 3: speed A22-20B5, A42-20B5
 4: speed A22-21B5, A42-21B5
 5: current 230 Vac, A22-05B5
 6: current 400 Vac, A42-05B5
 7: current 230 Vac, A22-10B5, A22-20B5
 8: current 400 Vac, A42-10B5, A42-20B5
 9: current 230 Vac, A22-21B5
 10: current 400 Vac, A42-21B5

Electrical Wiring Diagrams

AC-actuators

Electrak 5, LA24 and DMA - 1 × 230 Vac

Without anti coast brake*

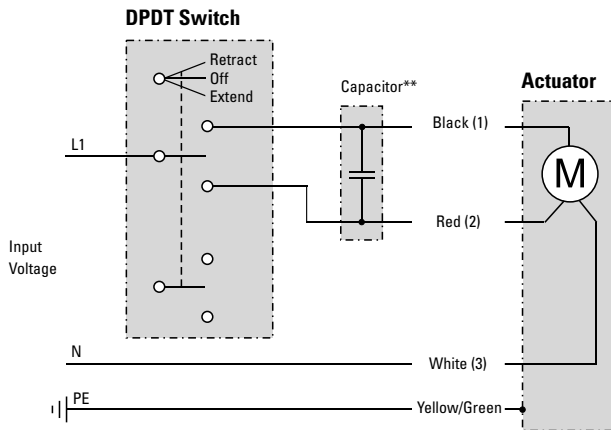

With anti coast brake*

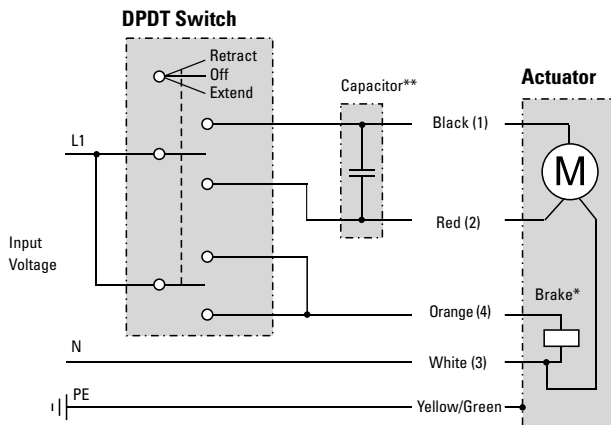

* Anti coast brake is standard on Electrak 5 / LA24 for ball screw models and optional for acme screw models. On DMA there are no anti coast brake on acme models while ball screw models always are equipped with an anti coast brake.

** 10 µF capacitor required to run the actuator, p/n 9200-448-003.

Leads can be either color or number marked. Connect black (1) lead to L1 and white (3) lead to N (neutral) to extend the actuator. Change L1 from lead black (1) to lead red (2) to retract the actuator. If the actuator is equipped with an anti coast brake, release the brake by connecting orange (4) lead lead to L1.

Electrak 5, LA24 and DMA - 3 × 400 Vac

Without anti coast brake*

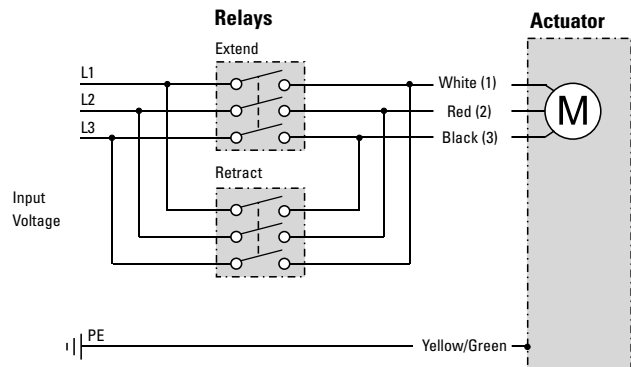

With anti coast brake*

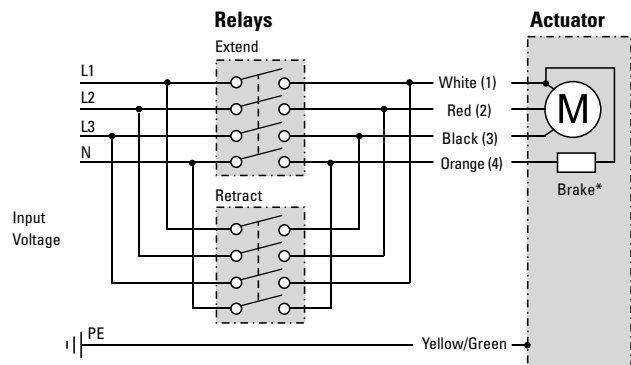

* Anti coast brake is optional on Electrak 5 / LA24 on both acme and ball screw models. On DMA there are no anti coast brake on acme models while ball screw models always are equipped with an anti coast brake.

Leads can be either color or number marked. Connect white (1) lead to L1, red (2) lead to L2 and black (3) lead to L3 to extend the actuator. Change the places of white (2) lead and black (3) to retract the actuator. If the actuator is equipped with an anti coast brake, release the brake by connecting orange (4) lead lead to N (neutral).

- page intentionally left blank -

Glossary

A – Cu

Acme Screw

Acme screws are self locking and will not backdrive. They also withstand vibration and shock better than ball or worm screws and are used for applications with these characteristics. Also see “lead screw”.

Actuator Housing

The actuator housing provides environmental protection for the internal components and may also be a structural member of the actuator.

Adapters

The front and rear adapters are the connection points for mounting most Danaher Motion actuators. The front adapter is usually a cross hole but optionally may be a tapped hole, threaded rod, or universal rod end. The rear adapter may be cast into the actuator housing or held in place with a nut.

Adjustable End of Stroke Limit Switches

The adjustable end of stroke limit switches may be moved to positions inside the full stroke of the actuator and will shut off the actuator when it reaches the limit switch. Also see “end of stroke limit switches”.

Anti Coast Brake/Electrical Brake

Depending on the load, AC ball screw actuators may coast to a stop when power is removed. This overrun is eliminated by an anti coast brake or an electrical brake. The anti coast brake (pawl type) will allow up to one revolution of the motor after power is removed. They are used on the Electrak 5 and PPA-AC with anti coast brake. An electrical brake (electrically released) operates much faster after power is removed and allow less coast than the pawl type. Electrak 205 and the PPA-AC with electrical brake use this type of brake. Also see “brake”.

Anti Rotation Mechanism

A feature available on some actuators that resolves the restraining torque within the actuator. The extension tube will not rotate on actuators with this feature.

Auto Reset Thermal Switch

An auto reset thermal will switch off the motor if it becomes too warm which means that the motor has exceeded its maximum allowed duty cycle. When the motor has cooled of the switch will close again automatically and the motor will start to run if power still is being applied to it. Also see “duty cycle”.

Ball Screw

Ball screws are highly efficient and are used for high loads and speeds. Also see “lead screw”.

Brake

Actuators using a acme or worm screw are inherently self-locking while ball screw driven actuators are not. To prevent ball screw actuators from backdriving they incorporate an anti backdriving brake (holding brake). Ball screw actuators with an AC motor can also be equipped with an anti coast brake. Also see “anti coast brake/electrical brake” and “holding brake”.

Capacitor

The ac actuators use permanent split capacitor motors and require the use of a start/run capacitor in the control circuit to operate. The controls for the ac actuators have the capacitor included in the control. For customer supplied controls, a separate capacitor is required and the part number is included on the actuator product page.

Certificates

CE certification and UL listing are the two main third party approvals available for actuators. Most of the AC actuators are UL listed as standard and UL has no standard for DC actuators under 48 Vdc. All actuators sold in the EU are CE certified while some actuators sold outside of the EU may not be. If you order your actuator outside of the EU and need a CE certification, contact the factory to verify availability and be sure to include the request on your order.

Controls

Controls can be external to the actuator and provide the actuator with the correct voltage, have either membrane or pendant operators and some have position indicators. The Pro series also has internal controls that continuously monitor the operation of the actuator.

Cover Tube

The cover tube provides protection for the lead screw and provides protection and support for the extension tube. For the Electrak 100 and PPA and as an option on the Electrak 205 actuators, the cover tube also provides the rear mounting connection.

Customization

Even the most versatile actuator may not always suit all applications. But whatever your need is, our engineers are ready to help you to customize the actuators according to your requirements. We build more exclusive actuators than anyone else and have decades of experience of producing actuators to meet special needs.

Glossary

Du – Fi

Duty Cycle

$$\text{Duty cycle} = \frac{\text{on time}}{(\text{on time} + \text{off time})}$$

Example: 15 seconds on, 45 seconds off

$$\frac{15 \text{ s}}{(15 \text{ s} + 45 \text{ s})} = 25\% \text{ duty cycle}$$

The duty cycle is a function of the maximum rated load and the ambient temperature. Ambient temperatures above the stated will affect the duty cycle negatively while lower temperatures and/or lower load will affect it positively. Review the following duty cycle versus load charts when higher duty cycles are needed for Electrak 1, Electrak 10 or DMD actuators.

Electrak 1, Electrak 1SP

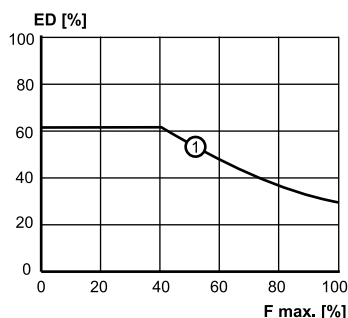

ED: duty cycle in percent at 25° C
 F max: percent of maximum rated load
 1: all Electrak 1 and Electrak 1SP models

Electrak 10, DMD

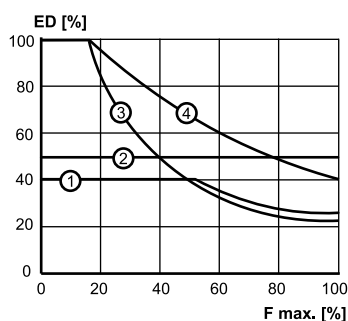

ED: duty cycle in percent at 25° C
 F max: percent of maximum rated load
 1: D •• -10A5 (acme screw) 3: D •• -05B5 (ball screw)
 2: D •• -20A5 (acme screw) 4: D •• -20B5 (ball screw)

Dynamic Load

The dynamic load rating is how much load the actuator will move when power is applied. Also see "load rating".

Dynamic Braking

Dynamic braking is a feature on the Pro series which short circuits the motor windings at power off resulting in a shorter

coasting distance before the actuator comes to a complete stop. Dynamic braking can be accomplished on other dc actuators by wiring the control to short the motor leads when power is removed.

Electronic Limit Switches (ELS)

ELS stands for Electronic Limit Switches and it is a current sensing function used in some actuator control models. The ELS senses the current and if the current exceeds a pre-set level the control cuts the power to the motor. This function can be used to detect and stop at the ends of the actuator stroke or to stop the actuator if it runs into an obstacle.

Electronic Load Monitoring (ELM)

A built-in microprocessor inside the Pro series actuators continuously monitors the performance of the actuator. The microprocessor will stop the movement at the end of stroke, in case of mid stroke stall, at overload conditions or if the duty cycle is too high. It also eliminates the need of a clutch and provides dynamic braking.

Encoder Feedback

Encoders provide a digital output signal that can be used to determine the position of the extension tube. An encoder equipped actuator must return to a "home" position if power is removed and restored in order to reset its starting point. Also see "potentiometer feedback".

End of Stroke Limit Switches

End of stroke limit switches are switches that are incorporated in some actuator models, either as standard or as an option, that will shut off power when the end of stroke is achieved. Also see "fixed end of stroke limit switches" and "adjustable end of stroke limit switches".

End Play (Backlash)

The stack up of tolerances within the lead screw assembly and gearing allowing some linear movement of the extension tube without rotating the motor. Typical end play or backlash varies by model. The range is 0,3 to 2,0 mm.

Extension Tube

The extension tube slides in and out of the actuator and is connected via the front adaptor to the load being moved or positioned.

Fixed End of Stroke Limit Switches

The fixed end of stroke limit switches allow the full stroke of the actuator to be used and will shut off power when the end of stroke is achieved. Also see "end of stroke limit switches".

Glossary

Ex – Life

Holding Brake

The Electrak 1, 2, 050, 150 and some Pro series incorporate an acme screw which is inherently self-locking while Electrak 5, 10, 100, 205 and the high load Pro series actuators have a ball screw drive incorporating an anti backdriving brake (holding brake) that engages when the actuator has come to a complete stop. Also see “brake”.

Input Voltage

The nominal voltage required to operate the actuator. All actuators will accept at least a $\pm 10\%$ variation of the nominal voltage but a change in the voltage will result in a change of the speed of dc actuators. Controls are available that accept 115 or 230 Vac input and provide 24 Vdc output to operate 24 Vdc actuators.

Installation Instructions

Each actuator has an installation manual to answer typical questions about mounting and wiring the actuators.

Lead Screw

Actuators use four different types of lead screws depending on the configuration and load requirements of the actuator. Ball screws are highly efficient and are used for high loads and speeds. Acme, worm and trapezoidal screws are self locking and will not backdrive. Acme and trapezoidal screws withstand vibration and shock better than the other and are used for applications with these characteristics.

Lifetime Expectancy

Life is a function of load, stroke length and how often the overload clutch is operated. The following life versus load charts will provide a life estimate for your particular application. Contact customer service for more information or for information on other actuator models.

Electrak 1, Electrak 1SP

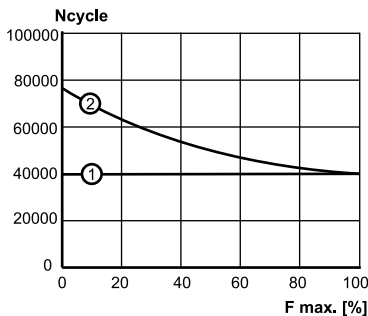

Ncycle: life in number of cycles (one cycle = extend and retract)
F max: percent of maximum rated load
1: Electrak 1 when using the internal limit switches for end of stroke
2: both models when using external limit switches for end of stroke

Electrak 10, DMD - Acme Screw Models

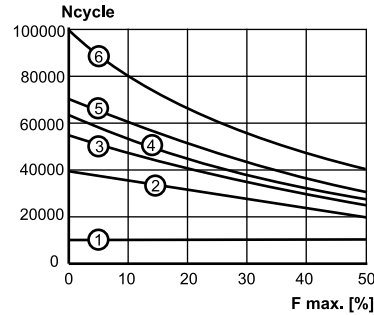

Ncycle: life in number of cycles (one cycle = extend and retract)
F max: percent of maximum rated load
1: all models using the clutch at end of stroke
2: D •• -20A5, 12 inch stroke
3: D •• -20A5, 8 inch stroke
4: D •• -10A5, 12 inch stroke
5: D •• -10A5, 8 inch stroke and D •• -20A5, 4 inch stroke
6: D •• -10A5, 4 inch stroke

Contact customer service if you need life estimates for loads above 1125 N or stroke lengths above 12 inch.

Electrak 10, DMD - Ball Screw Models

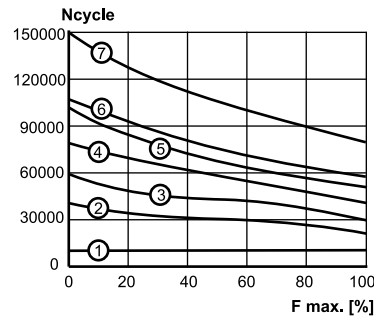

Ncycle: life in number of cycles (one cycle = extend and retract)
F max: percent of maximum rated load
1: all models using the clutch at end of stroke
2: D •• -10B5 and D •• -20B5, 12 inch stroke
3: D •• -10B5 and D •• -20B5, 8 inch stroke
4: D •• -05B5, 12 inch stroke
5: D •• -10B5 and D •• -20B5, 4 inch stroke
6: D •• -05B5, 8 inch stroke
7: D •• -05B5, 4 inch stroke

Contact customer service if you need life estimates for loads above 4500 N or stroke lengths above 12 inch.

Electrak 5, DMA - Ball Screw Models

Glossary

Lift – Ov

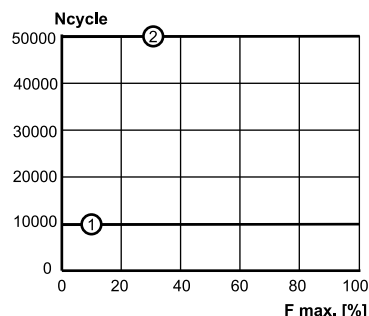

Ncycle: life in number of cycles (one cycle = extend and retract)

F max: percent of maximum rated load

1: all models using the clutch at end of stroke

2: all models using the anti-coast brake at end of stroke only

The above chart is only valid for ball screw models with rated load up to 4500 N and stroke lengths up to 12 inch. Contact customer service if you need life estimates for acme screw models or for higher loads or longer stroke lengths.

Lifting Columns

Lifting columns provide a stable base for adjusting the height of tables or platforms. The column provides both the lifting force and the ability to resolve high moment forces from off axis loads.

Linear Actuators

Actuators providing a linear thrust via an extension tube to lift, lower, push, pull or position a load.

Load Rating

The load rating is the minimum amount of force the actuator will provide during its lifetime. The load rating of all rod style actuators is the same for both compression and tension loads. Also see "dynamic load", "static load" and "tension and compression load".

Manual Override (Hand Wind)

Allows manual operation of the actuator in both directions in case of a power failure. The actuator accepts a standard hexagon key to rotate the motor in either direction. Optional on some models and standard on the Pro series.

Maximum On Time

The maximum amount of time an actuator may operate without stopping to "cool off". For high load and long stroke actuators this may be one extend and retract cycle. The actuator should not exceed 25% duty cycle at full rated load. If no maximum on time is stated then the maximum on time are equal to one full cycle at the maximum dynamic load for the actuator in question.

Mounting

Electrak actuators are quickly and easily mounted by slipping pins through the holes on each end of the unit and into brackets on the machine frame and the load. Electrak 100 units must be mounted by the cover tube and a swivel rod end. PPA actuators are mounted by the rear trunnions on the cover tube and the clevis on the extension tube. The Electrak 205 can be mounted by either the rear clevis or by a tube mount. 12,7 mm diameter solid pins (6,35 mm solid pins for Electrak 1 and 050) provide maximum holding strength and a retaining or cotter pin on each end will prevent the solid pin from falling out of its mounting bracket. Roll or spring type mounting pins should be avoided. The mounting pins must be parallel to each other as shown below (Fig. a). Pins which are not parallel may cause the actuator to bind. The load should act along the axis of the actuator since off center loads may cause binding (Fig. b).

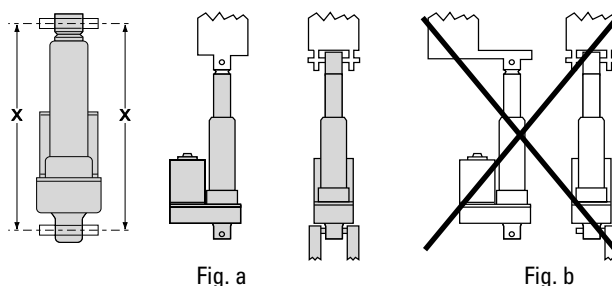

Non-driven Actuators

Actuators supplied without a motor and driven manually or by a customer supplied motor.

Operating and Storage Temperature

The operating temperature is the range in which the actuator may be safely operated. For the high end of the range, the duty cycle will be lower than 25%. All actuators can be stored or transported at the same temperature as the operating temperature. Contact customer support if the operating temperature will be exceeded during storage or transportation.

Output Voltage

Output voltage is the voltage from the control to run the actuator. The controls for dc actuators have 24 Vdc output. The controls for ac actuators have either 115 or 230 Vac output.

Overload Clutch

Electrak 050, 2, 5, 10, 100, 205 and PPA series linear actuators are protected by a load limiting mechanical clutch which prevents the motor from stalling at either end of the actuator stroke. It will also slip when the factory-set load limit is exceeded. The clutch is a ball detent design, assuring a consistent slip point and long life.

Glossary

Po – Si

Potentiometer Feedback

Potentiometers provide an analog output signal that can be used to determine the position of the extension tube. A potentiometer will “remember” its position if power is removed and restored. All potentiometers are set to a minimum value on full retract except for the EU versions of Electrak 5 and Electrak 10 where the minimum value are set on full extend. Also see “encoder feedback.”

Programmable Limit Switches

An optional control contained inside the Pro series to which an external programming box or customer supplied switches can be connected to set and reset the end of stroke limits as often as needed. The programming box has a “jog to position” switch and a “set limit” switch.

Protection Class

The protection class refers to the environmental rating of the enclosure. The first digit applies to airborne contaminants and the second digit to water/moisture.

- IP33: protected against the penetration of solid objects with a diameter greater than 12 mm and against direct sprays of water up to 60 degrees from vertical.
- IP44: protected against the penetration of solid objects with a diameter greater than 1 mm and against water sprayed from any direction.
- IP45: protected against the penetration of solid objects with a diameter greater than 1 mm and low pressure water jets from any direction.
- IP51: protected from dust and vertical dripping water/condensation.
- IP52: protected from dust and dripping water/condensation falling at an angle up to 15 degrees from vertical.
- IP56: protected from dust and high pressure water jets from any direction.
- IP65: dust tight and protected against low pressure water jets from any direction.
- IP66: dust tight and protected against high pressure water jets from any direction.
- IP67: dust tight and protected against the effect of immersion in water between 150 mm (5.9 inch) and 1 meter (39.4 inch).

Pulse Width Modulation (PWM)

Pulse width modulation control works by switching the power supplied to the motor on and off very rapidly. The DC voltage is converted to a square-wave signal, alternating between fully on and zero, giving the motor a series of power “kicks”. If the switching frequency is high enough, the motor runs at a steady speed due to its fly-wheel momentum. By adjusting the duty cycle of the signal (modulating the width of the pulse, hence the “PWM”), the time fraction it is “on”, the average power can be varied, and hence the motor speed. All DC actuators can

be speed controlled by PWM within certain limits without any adjustments except for the Pro series that due to the internal electronics must have a steady power supply.

Restraining Torque

The torque which is developed between the clevis on the extension tube and rear mount (clevis or trunnion) when the unit extends or retracts and ratchets the clutch (Fig. c).

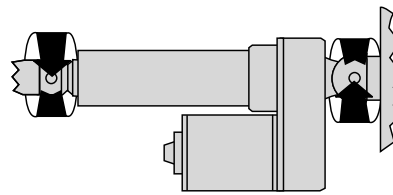

Fig. c

Rodless Actuators

Rodless actuators provide support for the load as well as thrust. The load is supported and moved by a carriage on the actuator rather than pushed or pulled by an extension rod. Rodless actuators are ideal for applications requiring long strokes (up to 1500 mm), high speeds (up to 110 mm/s), movement of the load within the shortest envelope possible or the load supported by the actuator.

RoHS Compliance

All actuators, controls and accessories sold in the EU are RoHS compliant unless otherwise stated, while products sold outside of the EU may not be. If you order an actuator outside of the EU and need it to be RoHS compliant, contact the factory to verify availability and be sure to include the request on your order.

Rotary Actuators

Actuators providing a rotary output to position a load, turn a winch, or rotate a gear or sprocket.

Service and Maintenance

Actuators are generally maintenance free. The Electrak 2, 5, 10, 100, 205 and Pro series have repair kits available from your local distributor or OEM.

Signal Follower Input / Control

An optional control contained inside the Pro series actuators that will cause the extension tube position to follow a customer supplied potentiometer signal. Also known as a position follower control.

Sizing and Selection

The Danahermotion.com web site includes a product advisor that can be used to walk through the decision process for picking the best actuator and to get the ordering data for your choice. Go

Glossary

Sp – W

to www.danahermotion.com/linear_actuator_advisor to find out more.

Speed

DC actuators have a direct load/speed relationship. As the load increases, the speed of the dc actuators decreases. There are curves on each product page to show the speed from no load to full rated load. AC actuators have very little speed fluctuations based on load but there are load/speed curves on all the ac actuator product pages.

Spline Safety Function

An optional safety function on the rodless actuator (LM80) that will stop downward motion in case the carriage (the moving member) collides with an obstacle. The motor will keep running but the carriage will stand still and not pull down on the obstacle. When reversing the motor rotation the carriage will automatically start to move upwards again.

Static Load

The static load rating is how much load the actuator will hold with power off. The static load rating is normally twice the dynamic load rating. Also see "load rating". If nothing else is stated the static load rating is for the actuator extension tube being fully retracted. The static load rating will decrease as the tube extends.

Synchronous Operation

Motor speed cannot be controlled with enough precision to ensure that the actuators will remain synchronized and a binding effect could take place. Non-driven actuators may be mechanically linked and thereby synchronized. Actuators equipped with an encoder can also be synchronized using controls designed for synchronous operation.

Tension and Compression Load

A tension load tries to stretch the actuator and a compression load tries to compress the actuator (Fig. d). Most actuators can manage the same tension and compression load. Also see "load rating".

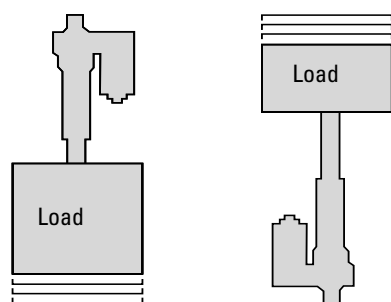

Fig. d

Trapezoidal Screw

Screw type with similar characteristics as an acme screw. This type of screw is used in TC16 and LM80. Also see "acme screw" and "lead screw".

Vent Tube

The Electrak 050 and 150 have a breather tube in the wiring harness to allow the actuator to operate without creating a vacuum and drawing water through the seals on the cover tube.

Voltage Drop

Long leads/cables between the power source and the actuator will result in a voltage drop for DC units. This voltage drop can be avoided by sizing the leads in accordance with the following lead

cross section selection table. The table is based on an ambient temperature of 30 °C or less. A higher ambient temperature may result in the need for a greater lead cross section.

Lead Cross Section Selection Table [mm²]

Current draw [A]	Cable length [m]	Actuator input voltage [Vdc]		
		12	24	36
0 - 10	0 - 3	1,5	1,5	1,5
	3 - 6	2,5	1,5	1,5
	6 - 10	4	1,5	1,5
10 - 15	0 - 3	1,5	2,5	1,5
	3 - 6	2,5	2,5	1,5
	6 - 10	4	2,5	1,5
15 - 20	0 - 3	2,5	-	-
	3 - 6	4	-	-
	6 - 10	6	-	-
20 - 28	0 - 3	4	-	-
	3 - 6	6	-	-
	6 - 10	10	-	-
28 - 35	0 - 3	6	-	-
	3 - 6	6	-	-
	6 - 10	10	-	-

Worm Screw

Worm screws are self locking and will not backdrive. This type of screw is used in Electrak 050. Also see "lead screw".

Application Data Form

Worksheet

Application Data Form*		
Submitted by:	Phone:	Date:
1. Company name	20. Do you need any special retracted length (cross hole c/c in mm)?	
2. Street address	21. Is anti-rotation of the extension tube required (yes/no)?	
3. City-state, zip	22. What is the input voltage?	
4. Contact name	23. Do you need any of the optional features of the actuator?	
5. Phone	24. How will the actuator be connected (standard or special cabling)?	
6. Fax	25. Is mating connector required if connector is included in the actuator?	
7. E-mail	26. Do you need any special paint or finish?	
8. What is the estimated annual volume?	27. Is manual override necessary?	
9. What is the target price?	28. What are the environmental conditions (dusty, outdoors, wash down)?	
10. What is the current or alternative solution?	29. What is the operation temperature range in Celsius?	
11. How much load is moved in Newton?	30. What is the duty cycle (on-time / on-time + off-time) in seconds?	
12. How much load do you need to hold in Newton?	31. Do you need any certificate (UL, CE, etc.)?	
13. How will the actuator be mounted (horizontal/vertical)?	32. Do you require any print (dwg, dxf, faxed)?	
14. Is the load trying to stretch or/and compress the actuator?	33. Describe any additional requirements (packaging, labeling, etc.)	
15. What speed do you want the actuator to move in mm/s?		
16. What is the life of the unit in cycles (one cycle = extend and retract)?		
17. What is the stroke length?		
18. How will the actuator be mounted to the extension tube?		
19. How will the actuator be mounted to the rear adaptor?		

* Please enter all fields in the form and send it and any drawing to customer service by mail or fax. See the back of the catalog for the nearest location.

Application Data Form

Drawing/notes

A large grid area for drawing or notes, consisting of 20 columns and 30 rows of small squares.

EUROPE

United Kingdom

Thomson
Fishleigh Road
Barnstaple
EX31 3UD
United Kingdom
Phone: +44 (0)1271 334 500
Fax: +44 (0)1271 334501
E-mail: sales.uk@thomsonlinear.com

Germany

Thomson
Nürtinger Straße 70
72649 Wolfschlugen
Phone: +49 (0) 7022 504 0
Fax: +49 (0) 7022 504 405
E-Mail: sales.wolfschlugen@thomsonlinear.com

Italy

Thomson
Largo Brughetti
I-20030 Bovisio Masciago
Italy
Phone: +39 0362 594260
Fax: +39 0362 594263
E-mail: info@thomsonlinear.it

Sweden

Thomson
Box 9053
SE-291 09 Kristianstad
Sweden
Phone: +46 (0) 44-24 67 00
Fax: +46 (0) 44-24 40 85
E-mail: helpdesk.kid@thomsonlinear.com

Switzerland

Thomson
La Pierreire 2
1029 Villars-Ste-Croix
Switzerland
Phone: +41 (0) 21 631 33 33
Fax: +41 (0) 21 636 05 09
E-mail: info@thomsonlinear.ch

France

Thomson
C.P 80018
12, Rue Antoine Becquerel – Z.I. Sud
F-72026 Le Mans Cedex 2
France
Phone: +33 (0) 243 50 03 30
Fax: +33 (0) 243 50 03 39
E-mail: sales.france@thomsonlinear.com

USA, CANADA and MEXICO

Thomson
203A West Rock Road
Radford, VA 24141 USA
Phone: 1-540-633-3549
Fax: 1-540-633-0294
E-mail: thomson@thomsonlinear.com
Literature: www.literature.thomsonlinear.com

ASIA

China

Thomson
Rm 2205, Scitech Tower
22 Jianguomen Wai Street
Beijing, China, 100004
Phone: +86 10 6515 0260
Fax: +86 10 6515 0263
E-mail: chinainfo@thomsonlinear.com.cn

Japan

Thomson
2F, Sigma Hatchobori Bldg,
2-7-1 Hatchobori Chuo-ku,
Tokyo 104-0032 Japan
Phone: +81-3-6222-1051
Fax: +81-3-6222-1055
E-mail: info@danahermotion.co.jp

Asia Pacific

Thomson
Unit A, 16 Floor, 169 Electric Road
Manulife Tower, North Point
Hong Kong
Phone: +852 2503 6581
Fax: +852 2571 8585
E-mail: victor.lim@thomsonlinear.com