

**Kawasaki**

**M2X  
M5X  
SERIES**

**Swash-plate Type Axial Piston Motors**

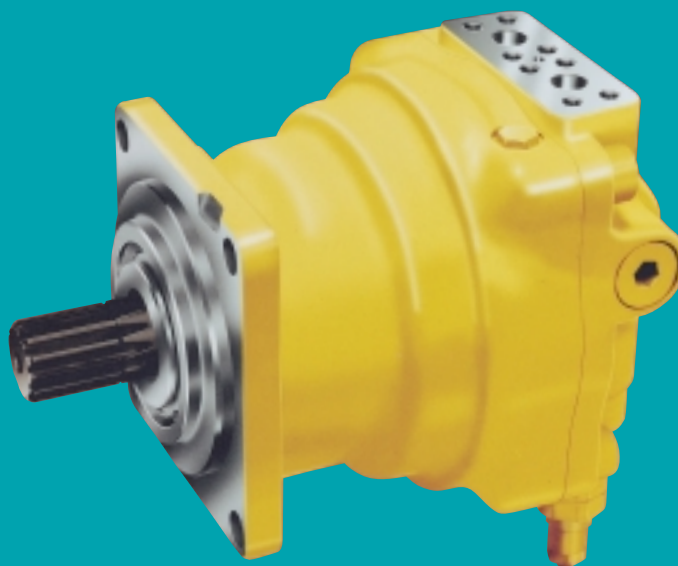





**KPM**  
Kawasaki Precision Machinery

# SAFETY PRECAUTIONS





Before you use the product, you **MUST** read the operation or operators manual and **MUST** fully understand how to use the product.

To use the product safely, you **MUST** carefully read all Warnings and Cautions in this manual. You **MUST** also observe the related regulations and rules regarding safety.







## ■ Cautions related to operation

- ①  Use the safety equipment to avoid the injury when you operate the product.  
CAUTION
- ②  Pay enough attention on handling method to avoid pinching hands or back problems that may be caused by heavy weight of the product or handling posture.  
CAUTION
- ③  Do not step on the product, hit it, drop it or give strong outside force to it, as one of these actions may cause the failure of work, damage or oil leakage.  
CAUTION
- ④  Wipe the oil on the product or floor off completely, as the oil creates slippery conditions that may result in dropping the product or injuring.  
CAUTION





## ■ Warnings and Cautions related to installation and removal of the product

- ①  Installation, removal, plumbing, and wiring must be done by the certified person.  
CAUTION  
\*CERTIFIED PERSON: a person who has enough knowledge like a person who is trained by Kawasaki's hydraulic school.
- ②  Make it sure that the power of the hydraulic power unit is turned off and that the electric motor or engine has completely stopped before starting installation or removal. You must also check the system pressure has dropped to zero.  
WARNING
- ③  Turn off the power before starting wiring or other works related to the electric power, otherwise you may be stuck by an electric shock.  
WARNING
- ④  Clean the threads and mounting surface completely, otherwise you may experience damages or oil leakage caused by insufficient tightening torque or broken seal.  
CAUTION
- ⑤  Use the specified bolts and keep the specified tightening torque when you install the product. Usage of unauthorized bolts, lack of torque or excess of torque may create problems such as failure of work, damage and oil leakage.  
CAUTION

## ■ Warnings and Cautions for operation

- ①  Never use the product not equipped with anti-explosion protection in the circumstances of possible explosion or combustion.  
DANGER
- ②  Shield the rotating part such as motor shaft and pump shaft to avoid injuries caused by being caught of fingers or cloths.  
WARNING
- ③  Stop the operation immediately if you find something wrong such as unusual noise, oil leakage or smoke, and fix it properly. If you continue operating, you may encounter damage, fire or injury.  
WARNING
- ④  Make it sure that plumbing and wiring are correct and all the connection is tightened correctly before you start operating, especially if it is the first run.  
CAUTION
- ⑤  Use the product under the specification mentioned in the catalog, drawings and specification sheet.  
CAUTION
- ⑥  Keep your body off the product during the operations as it may become hot and burn your body.  
CAUTION
- ⑦  Use the proper hydraulic oil, and maintain the contamination in the recommended level, otherwise it may not work or be damaged.  
CAUTION

## ■ Cautions related to maintenance

- ①  Never modify the product without approval of Kawasaki.  
CAUTION
- ②  Do not disassemble and assemble without approval by Kawasaki. It may cause troubles and failure, or it may not work as specified. If it is necessary by all means to disassemble and assemble, it must be done by an authorized person.  
CAUTION
- ③  Keep the product from dust and rust by paying attention to the surrounding temperature and humidity when you transport or store the product.  
CAUTION
- ④  Replacing the seals may be required if you use the product after long time storage.  
CAUTION

# Kawasaki M2X/M5X Series

## High Performance Motors for Swing Applications

### The product you have been waiting for...

## FEATURES

### 1. Compact

The design provides for an extraordinarily compact motor whereby the motor's rotating group, integral mechanical brake element and the attached valve options are neatly packaged together. Assembling the mechanical brake around the rotating group means that there is no configurational difference in motor installation which allows the optional provision of a brake.

### 2. Constructed specifically for Swing Operation

The motor's rotating group has been designed specifically for an excavator swing circuit and is based upon the abundant experience gained with the K series, N series and M series units on which Kawasaki's good customer reputation has been made.

### 3. Integrated Valving

Since the motor has built-in relief valve and make-up valve elements within the motor's valve block head cover, the connection of the piping from the control valve to the motor ports enables the motor to achieve swing function.

### 4. Directly Connected to Reduction Gear

The mounting flange of the motor has been enlarged so as to enable it to be directly connected with the ring gear of the reduction gear box.

## SPECIFICATIONS

Model		M2X63	M5X130	M5X180	M2X210	
Displacement		cm <sup>3</sup>	64.0	129.2	180.1	210.1
Pressure MPa (kgf/cm <sup>2</sup> )	Rated *1	29.4 (300)	32.4 (330)	32.4 (330)	29.4 (300)	
	Maximum *2	34.3 (350)	39.2 (400)	39.2 (400)	34.3 (350)	
Maximum speed *3		min <sup>-1</sup>	2,200	1,850	1,680	1,400
Rated output torque *4		N·m (kgf·m)	300 (31)	670 (68)	932 (95)	980 (100)
Rated output power *5		kW	69	129	163	144
Brake	Applicable maximum brake torque	N·m (kgf·m)	314 (32)	843 (86)	1,250 (127)	1,380 (141)
	Release pressure	MPa (kgf/cm <sup>2</sup> )	2.3 (23)	3.4 (34)	3.3 (33)	3.4 (35)
	Maximum allowable release pressure	MPa (kgf/cm <sup>2</sup> )	4.9 (50)			
Mass		kg	29	47	61	66

\*1 Pressure to allow guarantee of performance, functions and service life. Durability is unlimited (except for the bearing life).

\*2 Pressure to allow the setting which enables operation with no functional problems. Durability and service life are limited. Please consult us for details.

\*3 The suction pressure should be 0.1 MPa (1kgf/cm<sup>2</sup>) or above.

The maximum speed which can be achieved without functional problems. In some cases, operating pressure and/or flow will be limited.

\*4 The theoretical value at the rated pressure excluding mechanical efficiency.

\*5 The theoretical value at the rated pressure and maximum speed excluding both mechanical and volumetric efficiencies.

# CONSTRUCTION · OPERATION PRINCIPLE

## 1. Hydraulic Motor

As shown in the figure below, the high pressure oil passes through the inlet port (a) and flows into the cylinder block (4). Hydraulic force thus acts upon the piston (5), generating an axial force  $F$ . This force  $F$  is resolved through the shoe (2) into vector force  $F_1$  which acts perpendicular to the swash plate (3), and vector force  $F_2$  which is a vertical force with respect to the output shaft. The reaction force of force  $F_2$  is transmitted via the piston to the cylinder block, generating a rotational force which turns the output shaft. There are 9 equally spaced pistons in the cylinder block. The pistons connected to the high pressure inlet port transmit rotational torque sequentially to the output shaft. Reversing the flow of operating oil causes the output shaft to rotate in the opposite direction of rotation.

## 2. Parking Brake

This is a negative type, oil lubricated, multi-disc parking brake. That means that when the motor is not being operated, the brake piston (8) is pushed leftward by the springs (7) and the resultant friction through the separator plates restricts the rotation of the drive shaft from being able to rotate. If, however, a release pressure is applied through the release port to the oil chamber (6) such that the pressure force so generated is larger than the spring force, then the brake piston (8) moves to the right thereby providing a clearance between the individual separator plates. The brake is thereby released and the drive shaft can rotate freely.

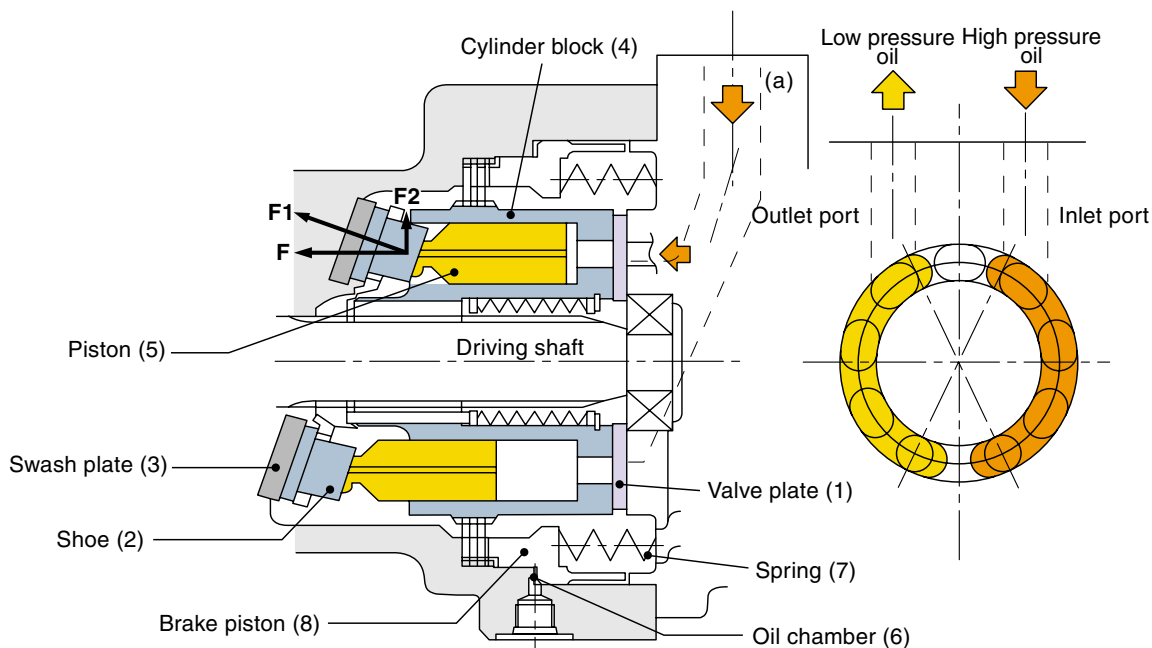

### ● Reference

Data are indicated in both the SI units and the gravitational units. The relationship between these two units are shown for reference.

SI units	gravitational units	
9.807 MPa	1,450 lbf/ft <sup>2</sup>	100 kgf/cm <sup>2</sup>
9.807 N·m	7,233 lbf·ft	1 kgf·m
0.735 kW	0.986 HP	1 PS
1 mm <sup>2</sup> /s	1 cSt	1 cSt

## ORDERING CODE

### ■ M2X/M5X Series Motor

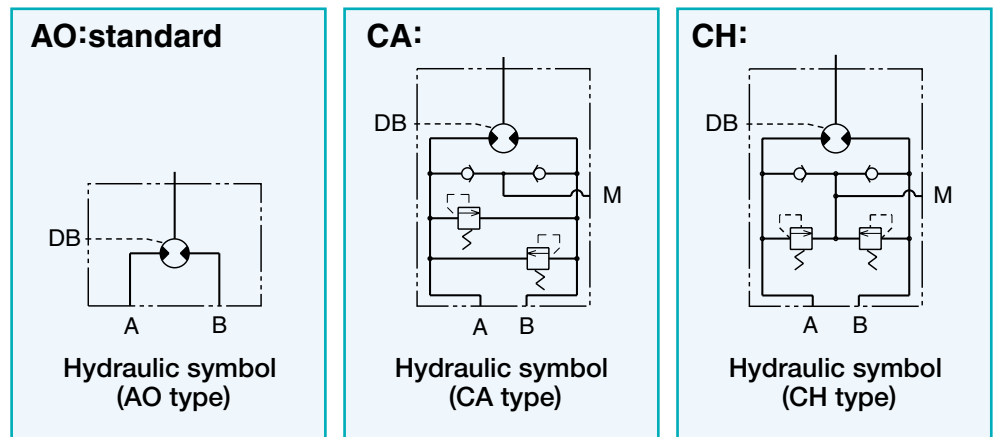
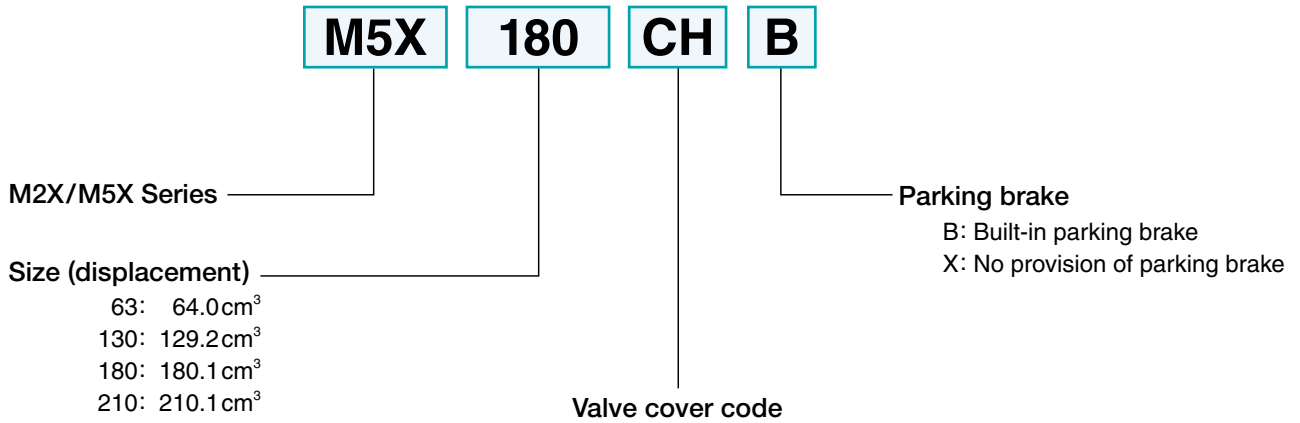

### ■ M2X/M5X-RG Series Motor

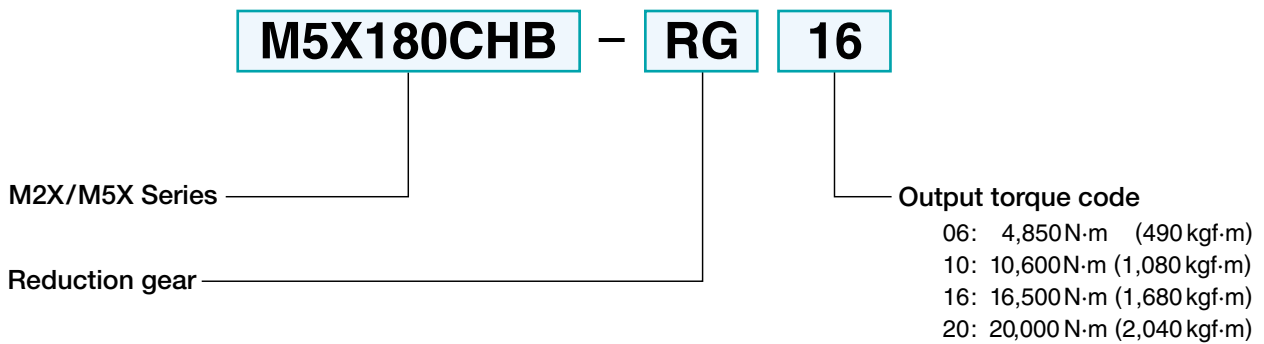

# ATTACHED VALVE

## ■ Relief valve (standard equipment in CA and CH type)

The relief valves built into M2X/M5X series motors have an excellent pressure override characteristic.

In addition this relief valve utilises a rate sensing technique to control the rate of pressure increase.

Due to the addition of this function motor acceleration and deceleration can be controlled with a minimum of shock.

### ● Pressurizing speed characteristics

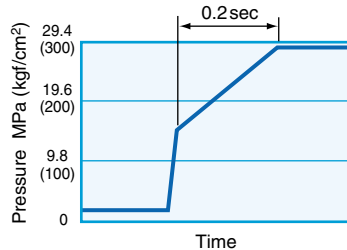

### ● Pressure override characteristics

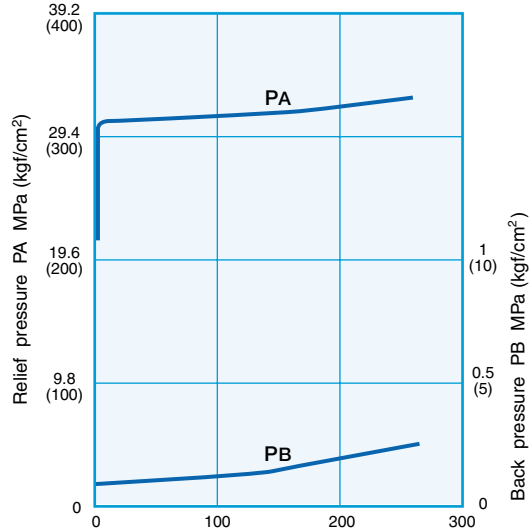

## ■ Anti-reaction valve (option)

When the operator wishes to decrease the jerkiness of swing operation, the anti-reaction valve option should be used whose examples of effects are shown in the figure to the right.

### ● Effect of the anti-reaction valve

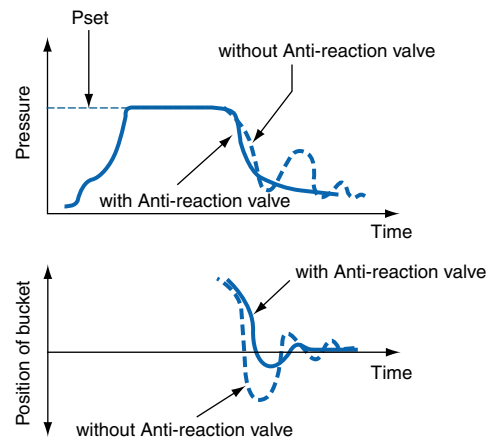

## ■ Time delay valve for parking brake (option)

It is important that the brake is only operated after the motor shaft has completely stopped.

The operating start time for brake applications should therefore be delayed to take into account all inertia conditions.

The valve has a function to delay the operating start time for brake application by installing it at the brake release port of the motor.

### ● Hydraulic symbol

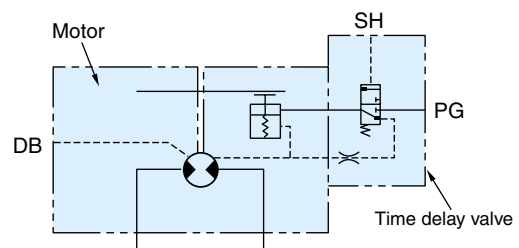

SH: Brake pilot port  
PG: Brake release port

# M2X63



● Use range

Pressure MPa (kgf/cm<sup>2</sup>)

Speed min<sup>-1</sup>

Max. speed: 2,200 min<sup>-1</sup>

Rated output torque: 300 N·m (31 kgf·m)

Rated output power: 69 kW

Applicable max. brake torque: 314 N·m (32 kgf·m)

Displacement: 64.0 cm<sup>3</sup>

Brake release pressure: 2.3 MPa (23 kgf/cm<sup>2</sup>)

Rated pressure: 29.4 MPa (300 kgf/cm<sup>2</sup>)

Max. brake release pressure: 4.9 MPa (50 kgf/cm<sup>2</sup>)

Max. pressure: 34.3 MPa (350 kgf/cm<sup>2</sup>)

Mass: 29 kg

## Dimensions

**CHB type** DB port: G3/8-15  
M port: G3/4-20

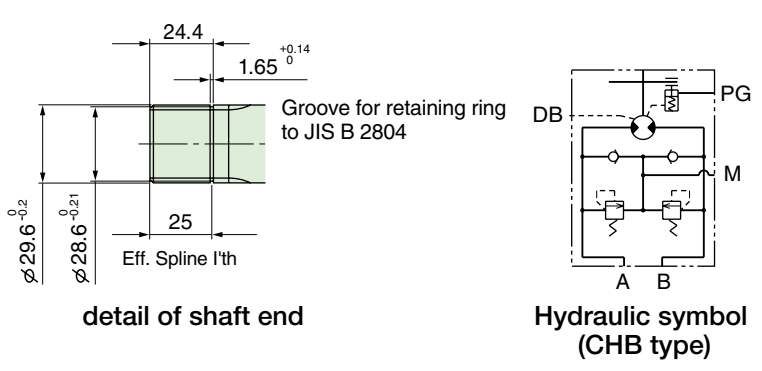
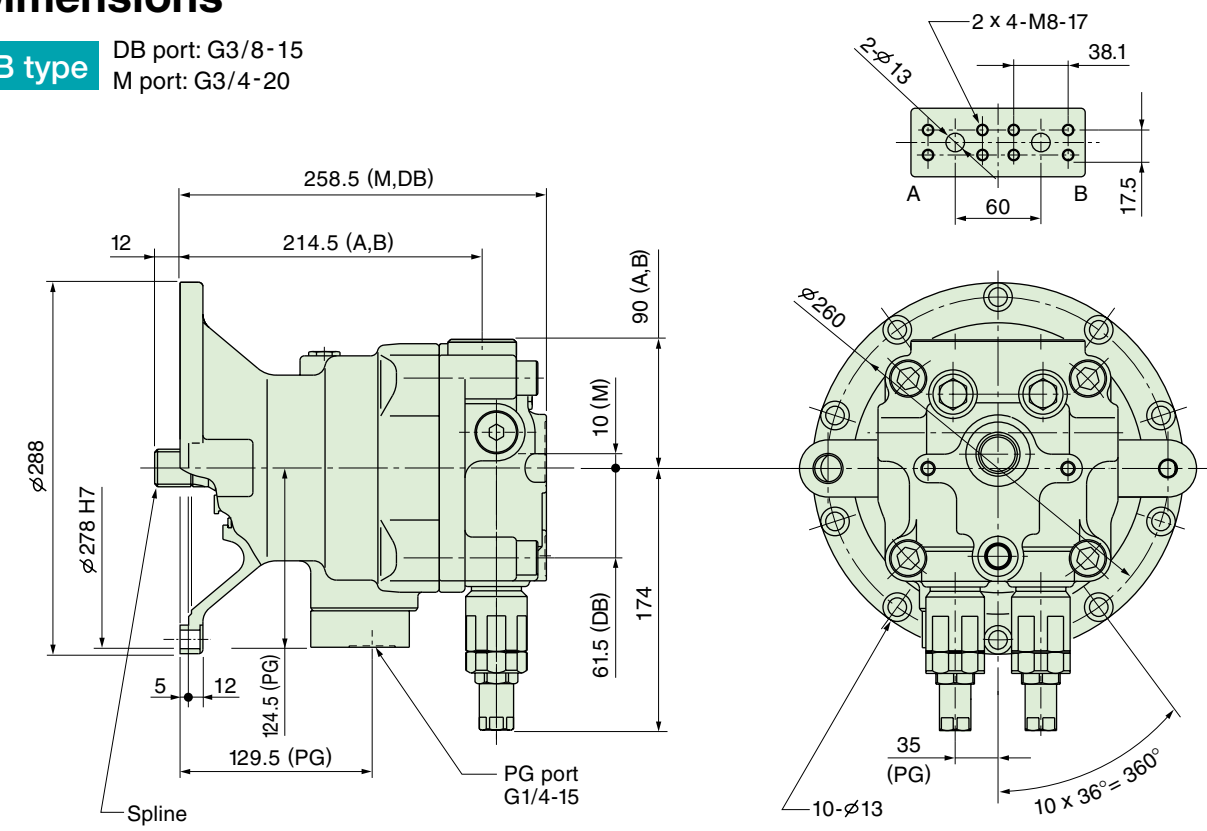

● Rotation

Inlet port	Outlet port	Direction of rotation viewed from shaft end
A	B	Clockwise
B	A	Counterclockwise

● Details of JIS involute spline

Number of teeth	16
Module	1.667

# Performance

[ Oil temperature: 50°C  
Viscosity: 30mm<sup>2</sup>/s (cSt) ]

The values given in the below figures are mean ones, and not guaranteed ones.

## Mechanical efficiency

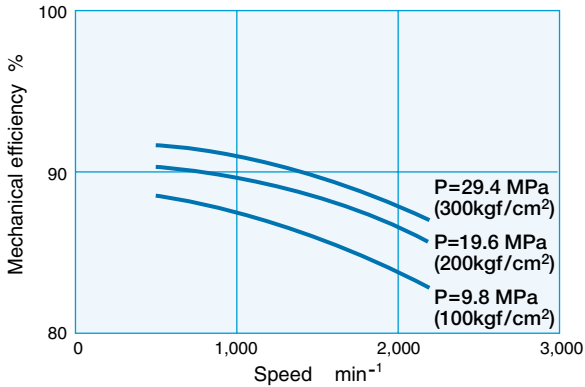

## Volumetric efficiency

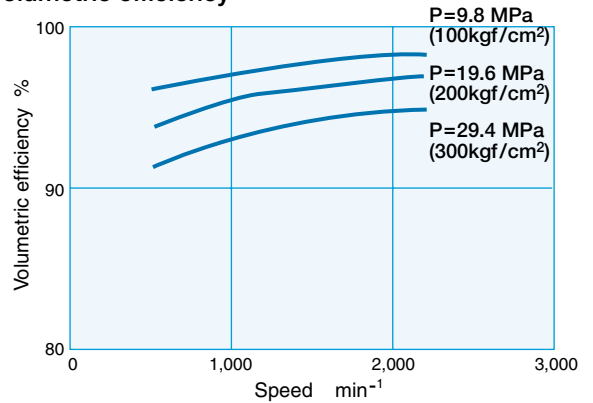

## Starting mechanical efficiency

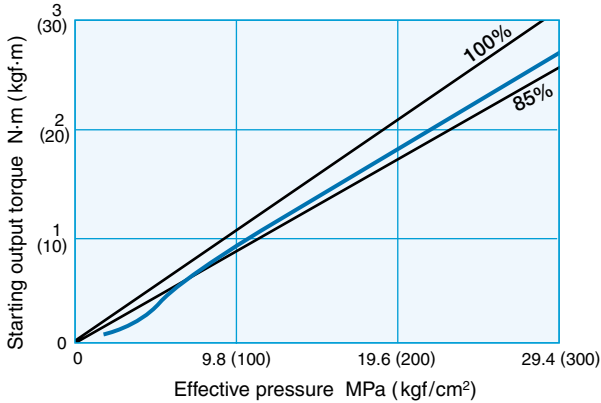

## Leakage

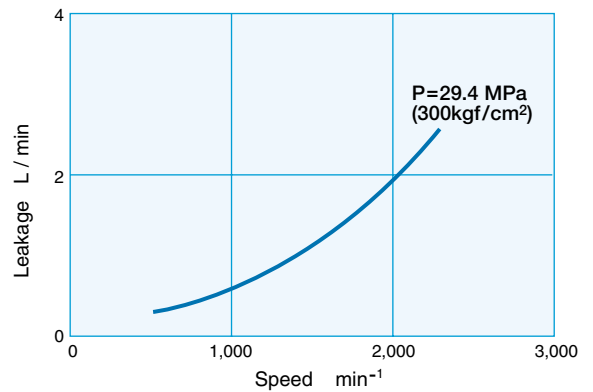

## Min. boost pressure (at M port or the suction port)

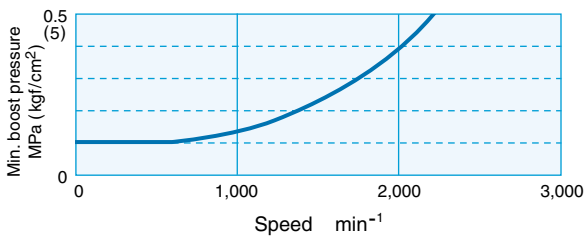

## Shaft creep speed

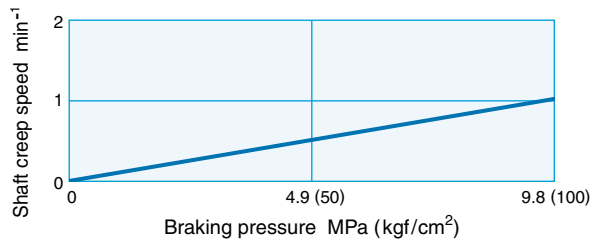

## Bearing life

The calculated life (B<sub>10</sub> life) shown in this graph is for speed No=1,000 min<sup>-1</sup>

Calculation of life for a random speed N is as follows.

$$L = \frac{N_0}{N} \times L_0 \quad (L_0: \text{calculated life for } N_0)$$

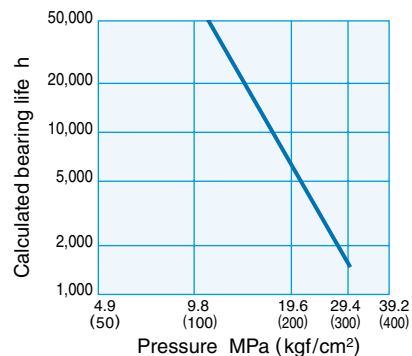





# Performance

[ Oil temperature: 50°C  
Viscosity: 30mm<sup>2</sup>/s (cSt) ]

The values given in the below figures are mean ones, and not guaranteed ones.

## ● Mechanical efficiency

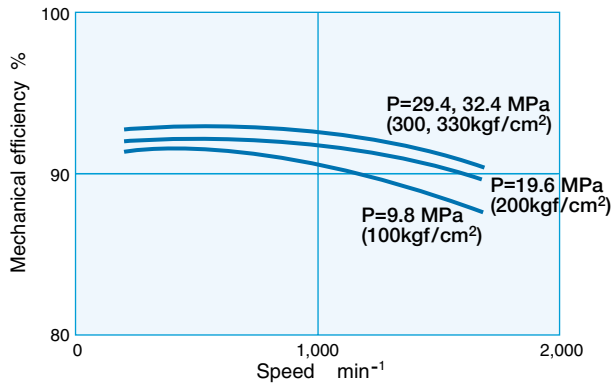

## ● Volumetric efficiency

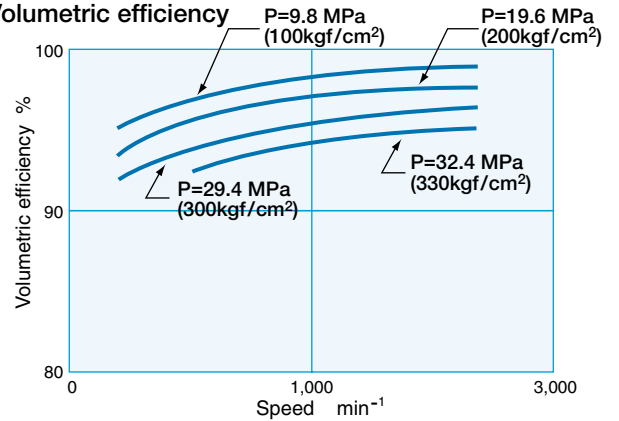

## ● Starting mechanical efficiency

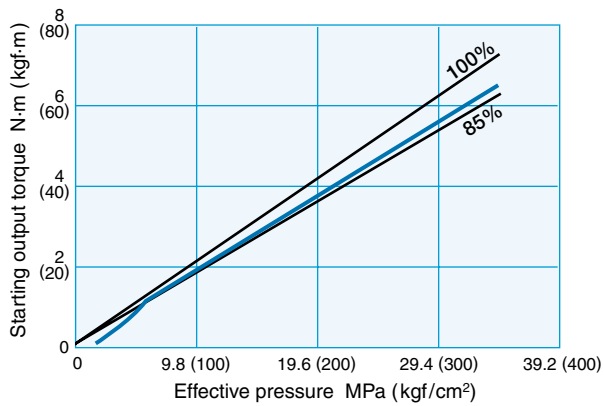

## ● Leakage

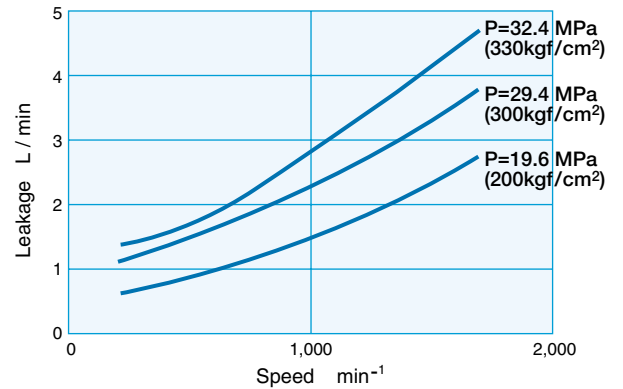

## ● Min. boost pressure (at M port or the suction port)

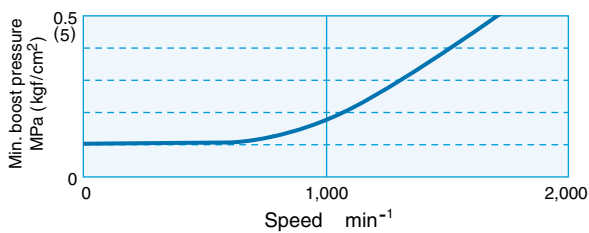

## ● Shaft creep speed

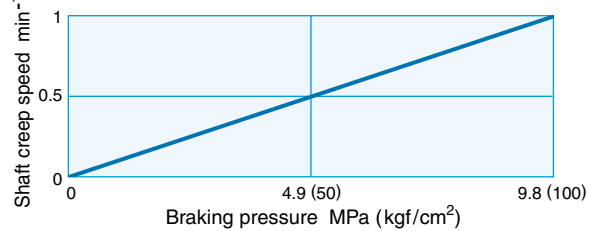

## ● Bearing life

The calculated life (B<sub>10</sub> life) shown in this graph is for speed No=1,000 min<sup>-1</sup>  
Calculation of life for a random speed N is as follows.

$$L = \frac{N_0}{N} \times L_0 \quad (L_0: \text{calculated life for } N_0)$$

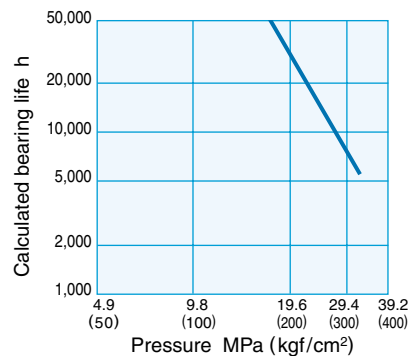

# M5X180



### ● Use range

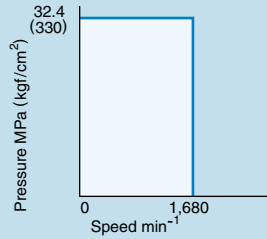

Max. speed: 1,680 min<sup>-1</sup>

Rated output torque: 932 N·m  
(95 kgf·m)

Rated output power: 163 kW

Applicable max. brake torque: 1,250 N·m  
(127 kgf·m)

Displacement: 180.1 cm<sup>3</sup>  
(169.4 cm<sup>3</sup>)

Brake release pressure: 3.3 MPa  
(33 kgf/cm<sup>2</sup>)

Rated pressure: 32.4 MPa  
(330 kgf/cm<sup>2</sup>)

Max. brake release pressure: 4.9 MPa  
(50 kgf/cm<sup>2</sup>)

Max. pressure: 39.2 MPa  
(400 kgf/cm<sup>2</sup>)

Mass: 61 kg

## ■ Dimensions

### AOB type

DB port: G1/2-19

M5X180-169

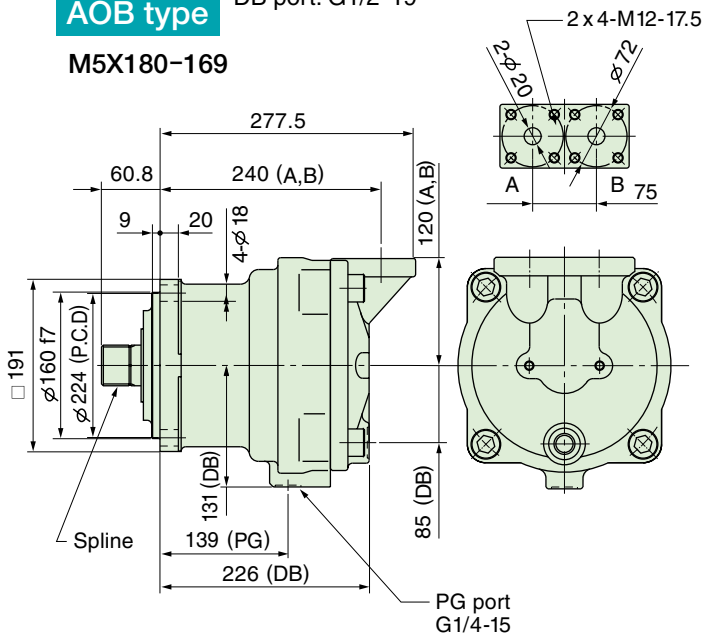

### CHB type

DB port: G1/2-19

M port: G1-24

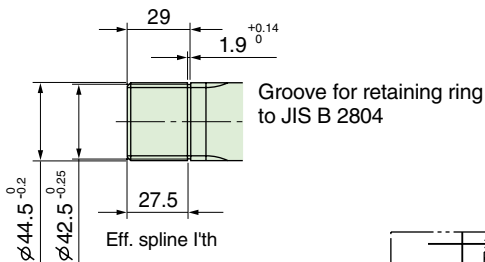
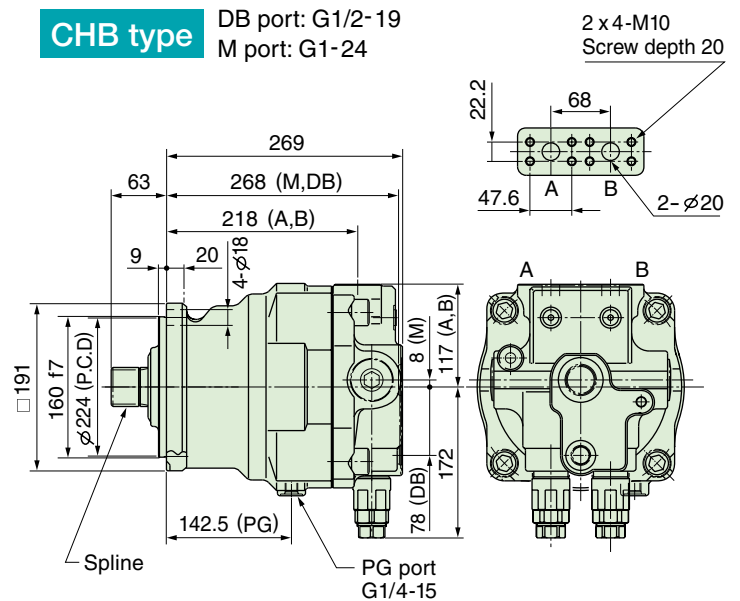

detail of shaft end

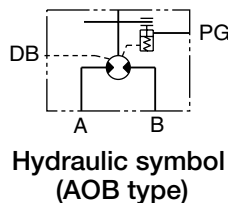

### detail of shaft end

Groove for retaining ring to JIS B 2804

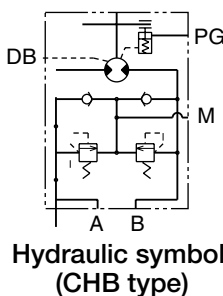
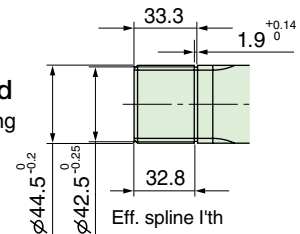

### ● Rotation

Inlet port	Outlet port	Direction of rotation viewed from shaft end
A	B	Clockwise
B	A	Counterclockwise

### ● Details of JIS involute spline

Number of teeth	16
Module	2.5

# Performance

[ Oil temperature: 50°C  
Viscosity: 30mm<sup>2</sup>/s (cSt) ]

The values given in the below figures are mean ones, and not guaranteed ones.

## Mechanical efficiency

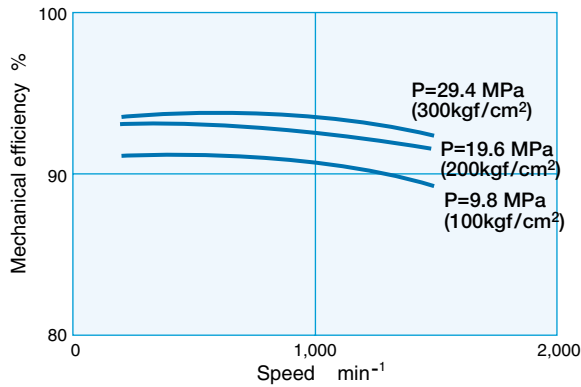

## Volumetric efficiency

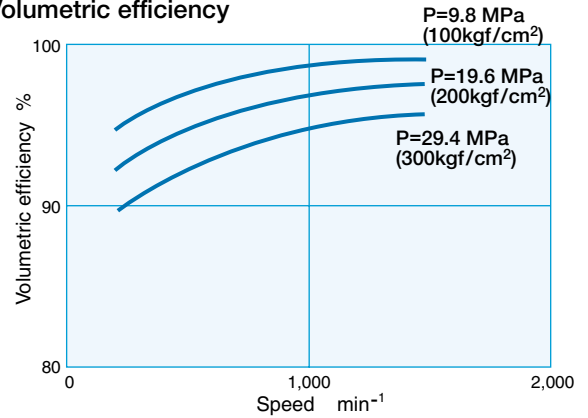

## Starting mechanical efficiency

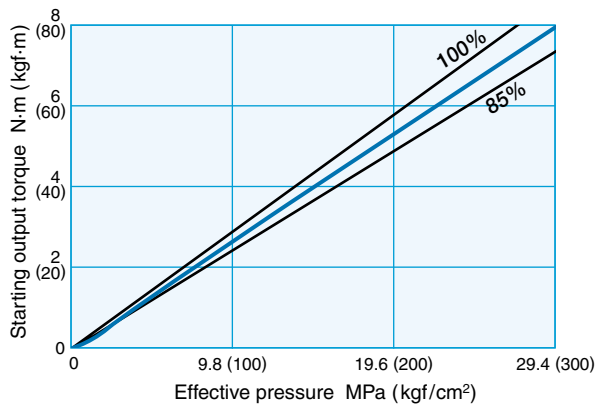

## Leakage

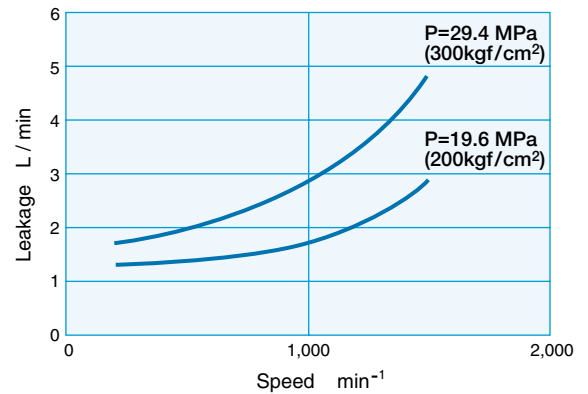

## Min. boost pressure (at M port or the suction port)

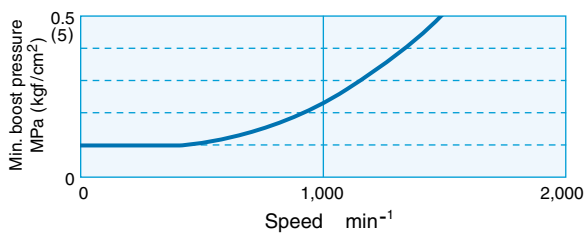

## Shaft creep speed

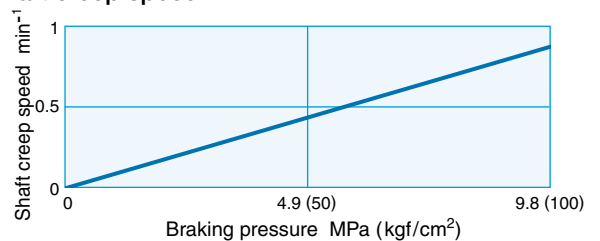

## Bearing life

The calculated life (B<sub>10</sub> life) shown in this graph is for speed No=1,000 min<sup>-1</sup>  
Calculation of life for a random speed N is as follows.

$$L = \frac{N_0}{N} \times L_0 \quad (L_0: \text{calculated life for } N_0)$$

### M5X180AOB

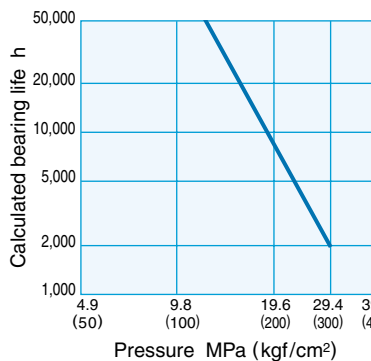

### M5X180CHB

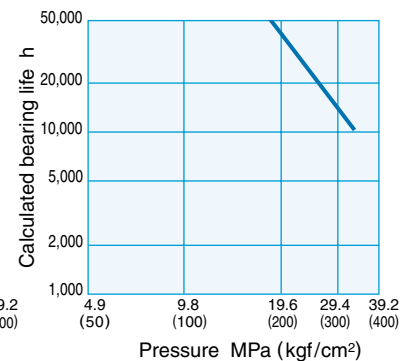

# M2X210



### ● Use range

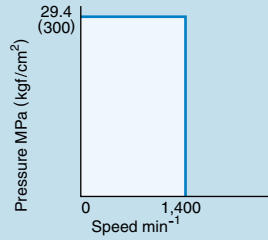

Max. speed: 1,400 min<sup>-1</sup>

Rated output torque: 980 N·m  
(100 kgf·m)

Rated output power: 144 kW

Applicable max. brake torque: 1,380 N·m  
(141 kgf·m)

Displacement: 210.1 cm<sup>3</sup>

Brake release pressure: 3.4 MPa  
(35 kgf/cm<sup>2</sup>)

Rated pressure: 29.4 MPa  
(300 kgf/cm<sup>2</sup>)

Max. brake release pressure: 4.9 MPa  
(50 kgf/cm<sup>2</sup>)

Max. pressure: 34.3 MPa  
(350 kgf/cm<sup>2</sup>)

Mass: 66 kg

## ■ Dimensions

**AOB type** DB port: G1/2-19

**CHB type** DB port: G1/2-19  
M port: G1-24

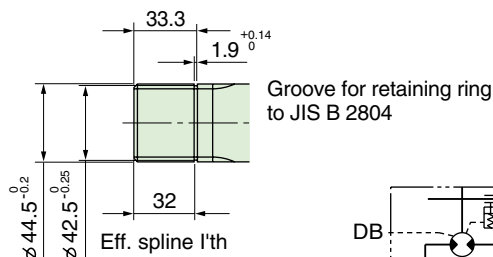
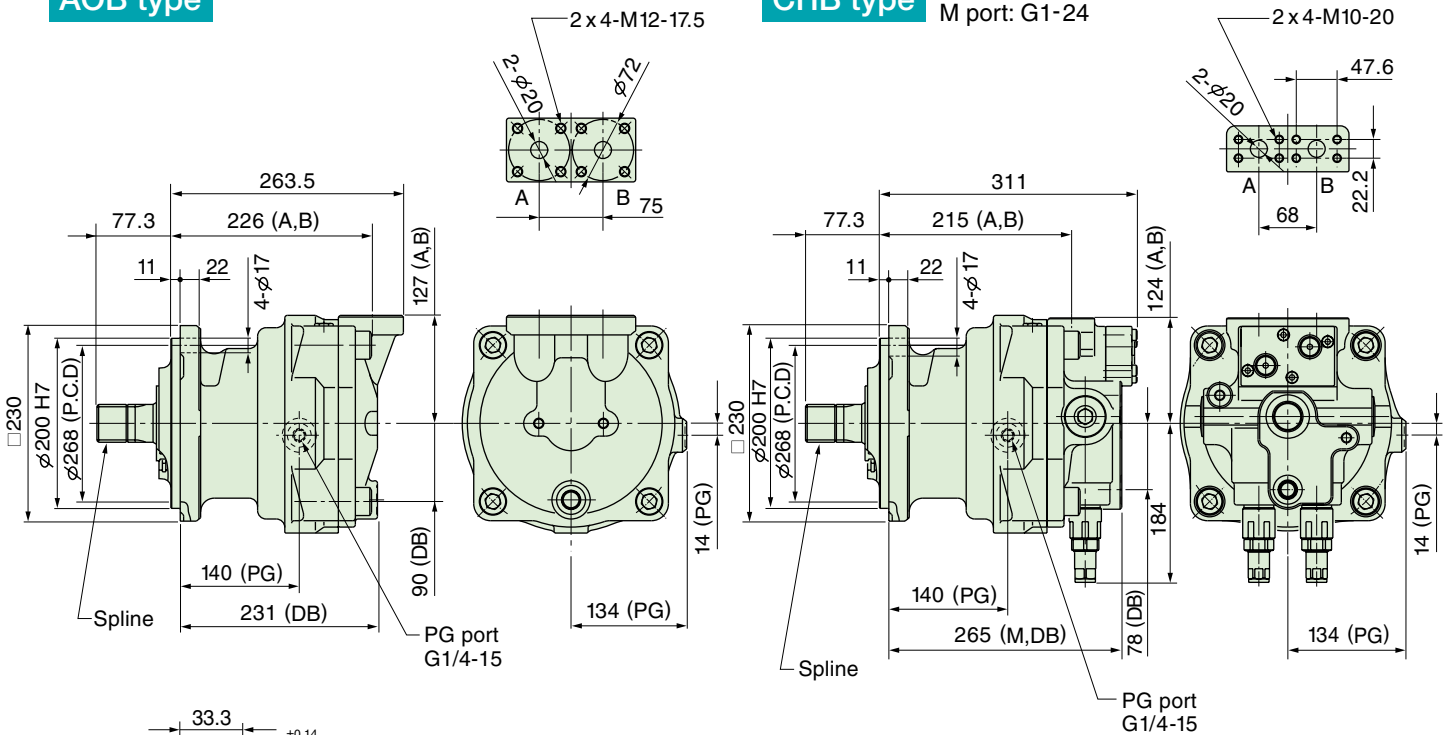

detail of shaft end

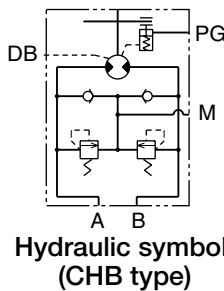
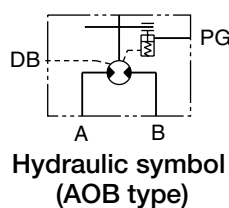

### ● Rotation

Inlet port	Outlet port	Direction of rotation viewed from shaft end
A	B	Clockwise
B	A	Counterclockwise

### ● Details of JIS involute spline

Number of teeth	16
Module	2.5

# Performance

[ Oil temperature: 50°C  
Viscosity: 30mm<sup>2</sup>/s (cSt) ]

The values given in the below figures are mean ones, and not guaranteed ones.

## ● Mechanical efficiency

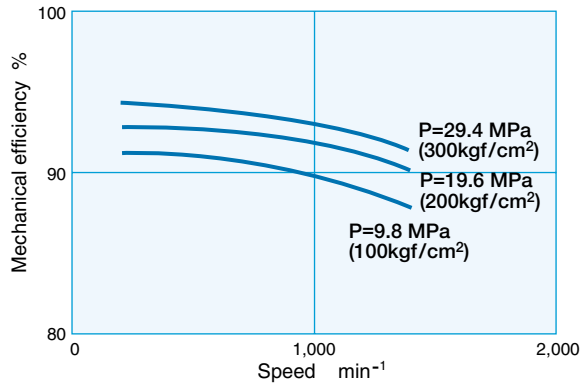

## ● Volumetric efficiency

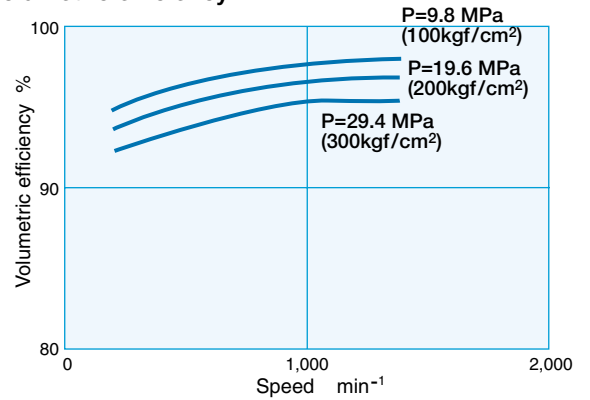

## ● Starting mechanical efficiency

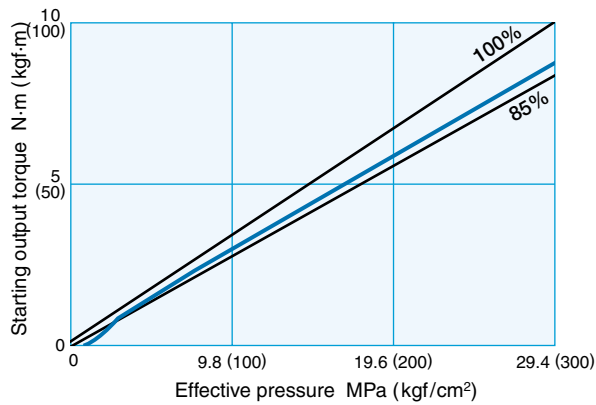

## ● Leakage

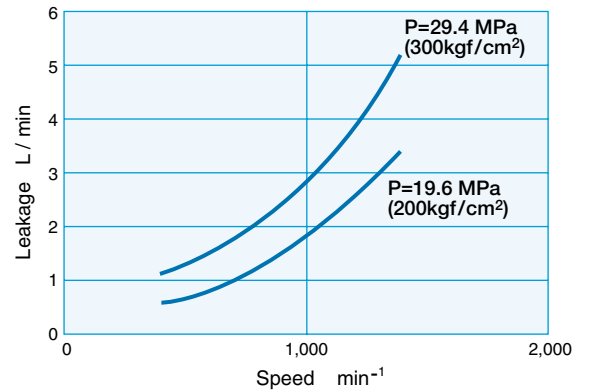

## ● Min. boost pressure (at M port or the suction port)

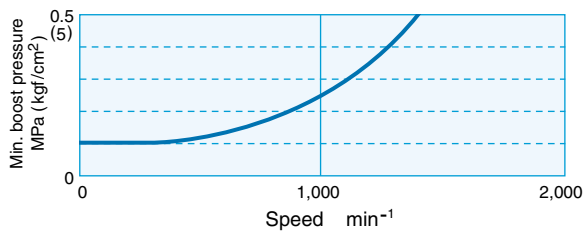

## ● Shaft creep speed

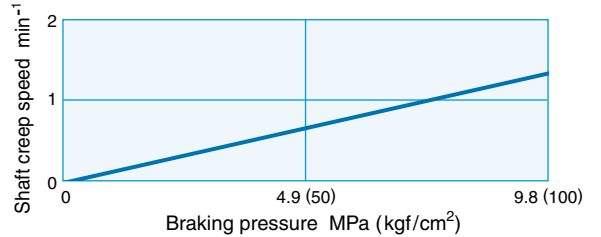

## ● Bearing life

The calculated life (B<sub>10</sub> life) shown in this graph is for speed No=1,000 min<sup>-1</sup>  
Calculation of life for a random speed N is as follows.

$$L = \frac{N_0}{N} \times L_0 \quad (L_0: \text{calculated life for } N_0)$$

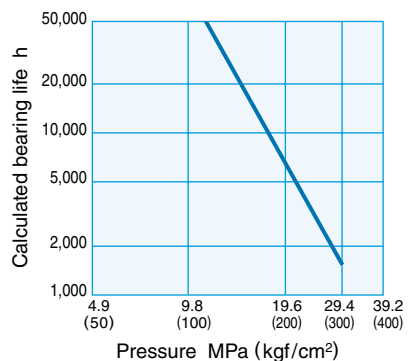

# M2X / M5X-RG

## Specifications

1MPa=10.197kgf/cm<sup>2</sup>  
1N·m=0.10197kgf·m

Model	Displacement (cm <sup>3</sup> )	Rated pressure (MPa)	Max. speed (min <sup>-1</sup> )	Theoretical output torque (N·m)	Gear ratio	Shaft type	Applicable max. brake torque (N·m)	Mass (kg)
M2X63-RG06	1,229	28.0	115	5,450	19.2	with Swing pinion	6,030	104
M5X130-RG10	2,437	27.4	92	10,600	20.0		17,500	203
M5X180-RG16	4,128	23.0	67	16,500	25.0	Involute spline (JIS)	30,300	331
M5X180-RG20	4,264	29.4	77	20,000	21.8	with Swing pinion	26,400	419

## Calculated bearing life (B<sub>10</sub> life)

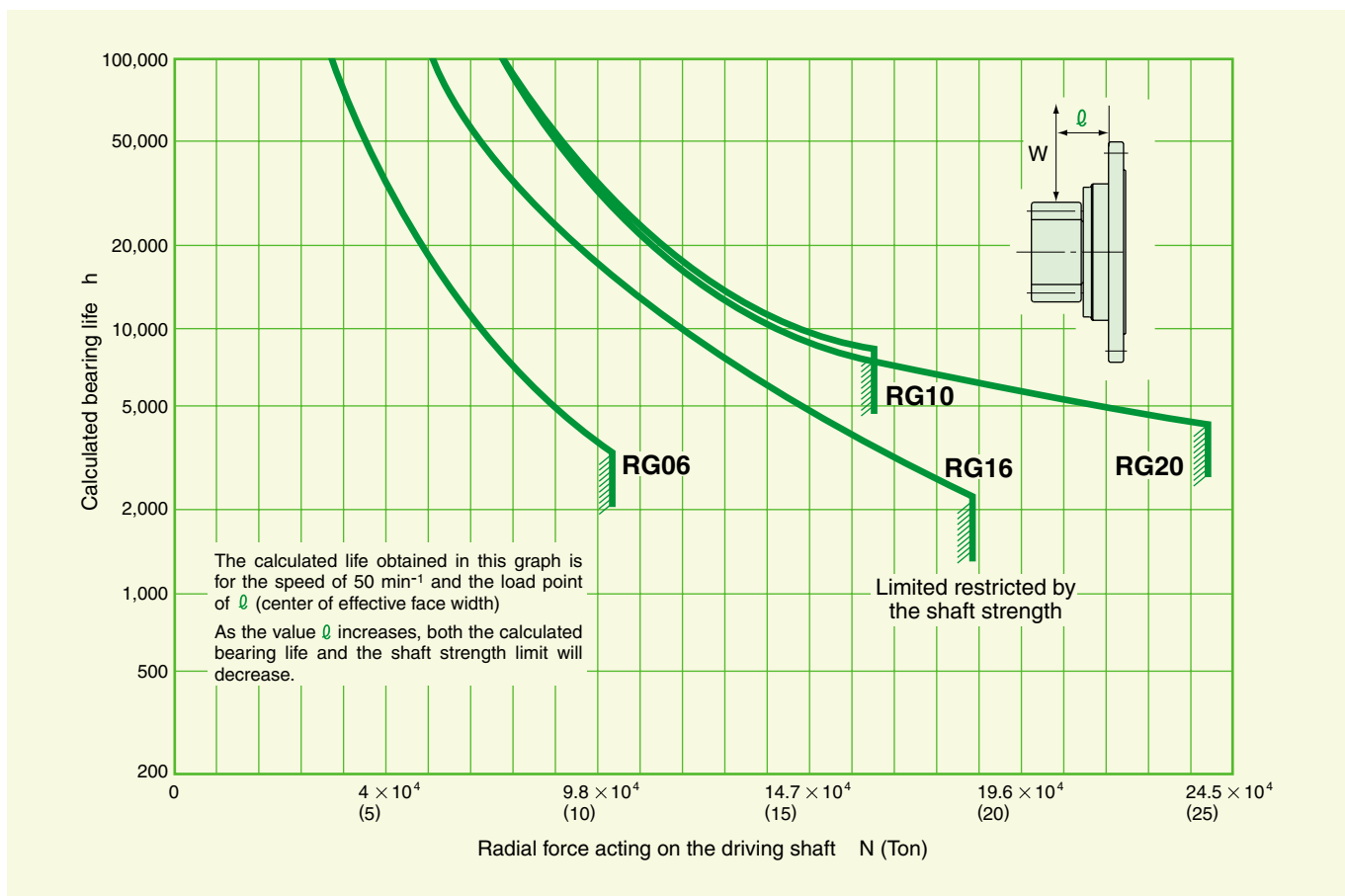

The bearing life is in inverse proportion to the speed.

### Other Caution

- (1) The strength of gears is influenced by the operating pressure. Please consult us, if necessary.
- (2) Use gear oil equivalent to GL-3 or GL-4 of API classification.

## ■ Dimensions

M2X63-RG 06  
M5X130-RG 10  
M5X180-RG 16  
M5X180-RG 20

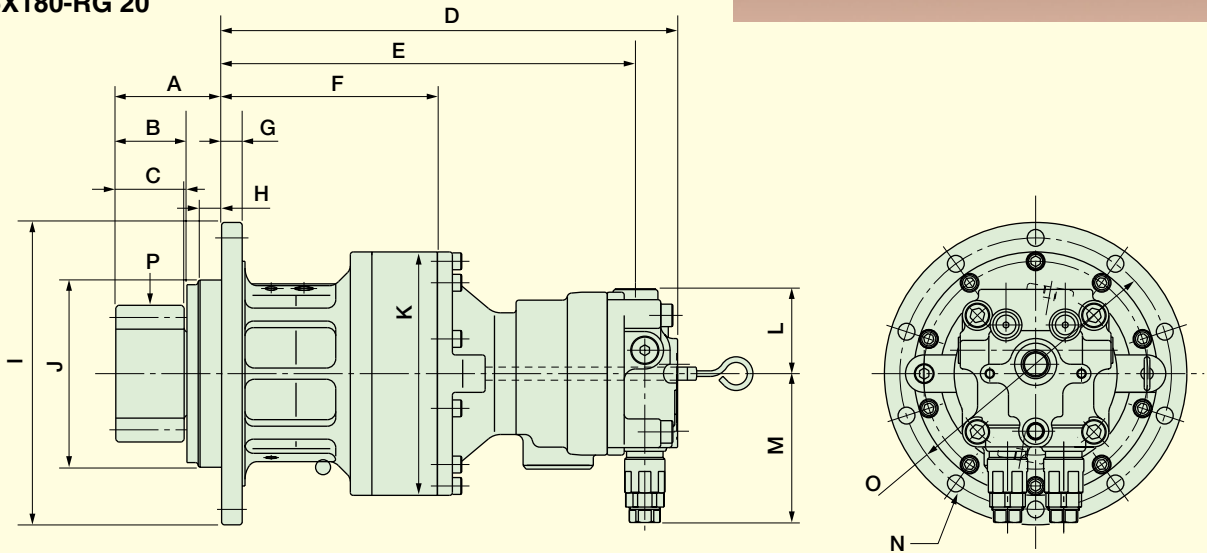

Model	A	B	C	D	E	F	G	H	I	J
<b>M2X63-RG 06</b>	113	76	73	487	442	230	22	25	∅ 323	∅ 200f8
<b>M5X130-RG 10</b>	162	102	94	568	578	284	30	15	∅ 410	∅ 310f7
<b>M5X180-RG 16</b>	168	80	74	578	527	271	32	15	∅ 570	∅ 390f8
<b>M5X180-RG 20</b>	182	112	110	676	625	407	30	15	∅ 528	∅ 380f7

Model	K	L	M	N	O	P
<b>M2X63-RG 06</b>	∅260	90	159	9-∅18+1-∅20 (reamer hole) (36° pitch)	∅ 290	m=10, z=12, (with pinion)
<b>M5X130-RG 10</b>	∅305	114	166	11-∅22+1-∅24 (reamer hole) (30° pitch)	∅ 360	m=12, z=13, (with pinion)
<b>M5X180-RG 16</b>	∅424	117	184	16-∅20 (22.5° pitch)	∅ 520	m=5, z=20, involute spline (JIS)
<b>M5X180-RG 20</b>	∅445	117	184	14-∅25 (12.857° pitch)	∅ 484	m=14, z=14, (with pinion)



## CAUTION FOR OPERATING



CAUTION

### 1. Operating fluid and temperature range

- ① Please use antiwear hydraulic fluid as operating fluid.
- ② The allowable ranges of operating fluid are as follows.  
Viscosity: 10 ~ 1,000 mm<sup>2</sup>/s (cSt)  
Temperature: -20 ~ +90°C
- ③ In case of using special fluid (Phosphate ester compounds, water-glycol fluid, fatty acid ester compounds, etc.) please consult us for instructions prior to use.



CAUTION

### 2. Filtration

For satisfactory service life of these motors application, the operating fluid should be controlled cleaner than the cleanliness level of NAS1638 Class9. Install a 10 μm filter in the return circuit of respective actuators.



CAUTION

### 3. Mounting

- ① The motor should be installed with the shaft either horizontal or vertically down.
- ② Alignment should be so carried out that the parallel error may be held within ±0.05 mm.



CAUTION

### 4. Drain piping

- ① The motor's drain port, as shown in the following figure, should be so located that the casing can be filled with oil.
- ② Use a drain tube bigger in size than the motor's port. Keep the casing pressure normally below 0.2 MPa (2kgf/cm<sup>2</sup>) and below 0.6 MPa (6kgf/cm<sup>2</sup>) even at the peak.

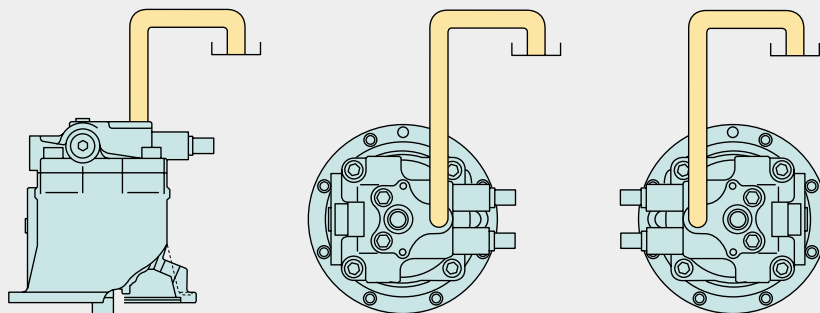



CAUTION

## 5. Oil filling and air venting

Before operation, be sure to fill the casing with oil through the drain port (DB port). Vent all air out of the motor and hydraulic circuit prior to operation. The insufficient amount of oil may cause the lubrication failure, resulting in the seizure of internal parts. The values given in the table below are the amount of oil in the motor case.

Model	M2X63	M2X130	M2X180	M2X210
Amount of oil (L)	0.5	0.8	1.0	1.5



WARNING

## 6. Parking brake

This brake should be used only for parking, are not for dynamic braking. In case of driving inertial load, measures such as the adoption of the time delay valve should be taken to prevent the parking brake from being activated before the inertial mass stops.



WARNING

## 7. Radial and thrust load

- ① Do not apply radial or thrust load to the shaft of these motors. In case of possible occurrence of the above-stated load at the shaft, provide an additional bearing unit on the driven side.
- ② In case the sun gear of a planetary gear box is driven, the above-stated bearing unit is not always required. However, careful alignment should be carried out to avoid unbalance force to the shaft from the gear box.
- ③ Radial or thrust load may be applied to the shaft of the M2X/M5X-RG Series. Such load, however, will affect the bearing life and the shaft strength. Refer to the data on page 15.



CAUTION

## 8. Cavitation

When the motor is operating in an overrunning (pumping) mode, then to prevent the occurrence of cavitation, a positive boost pressure is required at the M port or the suction port. Please ensure that the minimum boost pressure requirement shown in the model performance data is always available.



CAUTION

## 9. Back pressure

The lower of the two main motor ports pressures should always be less than 2.5 MPa (25kgf/cm<sup>2</sup>). Pressure higher than this could cause a possible reduction in motor performance. In case of any doubt please consult.

# KAWASAKI PRECISION MACHINERY NETWORK

---

## *Kawasaki Precision Machinery Ltd.*

### Head Office / Main Plant

234, Matsumoto, Hasetani-cho, Nishi-ku, Kobe 651-2239, Japan  
Phone: 81-78-991-1133 Fax: 81-78-991-3186

### Tokyo Office

World Trade Center Bldg., 4-1, Hamamatsu-cho 2-chome, Minato-ku, Tokyo 105-6116, Japan  
Phone: 81-3-3435-6862 Fax: 81-3-3435-2023

### Kobe Office

Kobe Crystal Tower, 1-3, Higashikawasaki-cho 1-chome, Chuo-ku, Kobe, 650-8680, Japan  
Phone: 81-78-360-8608 Fax: 81-78-360-8609

<http://www.khi.co.jp/kpm/>

## OVERSEAS SUBSIDIARIES

---

### Kawasaki Precision Machinery (UK) LTD.

Ernesettle Lane, Ernesettle, Plymouth, Devon PL5 2SA, United Kingdom  
Phone: 44-1752-364394 Fax: 44-1752-364816

<http://www.kpm-eu.com>

### Kawasaki Precision Machinery of America Division of Kawasaki Motors Corp., U.S.A.

5080, 36th St. S.E. Grand Rapids, MI 49512, U.S.A.  
Phone: 1-616-949-6500 Fax: 1-616-975-3103

<http://www.kawasakipmd.com>

### Flutek, Ltd.

192-11, Shinchon-dong, Changwon, Kyungnam, 641-370 Korea  
Phone: 82-55-286-5551 Fax: 82-55-286-5553

### KK HYDRAULICS SALES (SHANGHAI) LTD.

B-908 Far East International Plaza 317 Xianxia Rd, Shanghai 200051  
Phone: 86-21-62351606 Fax: 86-21-62957080

## KAWASAKI HEAVY INDUSTRIES, LTD.

### OVERSEAS OFFICES

---

#### Seoul Office

c/o Kawasaki Machine Systems Korea, Ltd. 3rd Floor (307), Industrial Complex Support Bldg., 637, Kojan-Dong, Namdong-Gu, Incheon, 405-817, Korea  
Phone: 82-32-821-6941 Fax: 82-32-821-6947

#### Beijing Office

Room No.2602, China World Tower 1, China World Trade Center, No.1 Jian Guo Men Wai Avenue, Beijing 100004, People's Republic of China  
Phone: 86-10-6505-1350 Fax: 86-10-6505-1351

#### Shanghai Office

13th Floor, HSBC Tower, 101 Yin Cheng East Road, Pudong New Area, Shanghai 200120, People's Republic of China  
Phone: 86-21-6841-3377 Fax: 86-21-6841-2266

#### Taipei Office

15th Floor, Fu-Key Bldg., 99 Jen-Ai Road Section 2, Taipei, Taiwan  
Phone: 886-2-2322-1752 Fax: 886-2-2322-5009

#### Bangkok Office

17th Floor, Ramaland Bldg., 952 Rama IV Road, Bangrak, Bangkok 10500 Thailand  
Phone: 66-2-632-9511 Fax: 66-2-632-9515

#### Kuala Lumpur Office

Letter Box No. 162, 6th Floor, UBN Tower, 10 Jalan P. Ramlee 50250, Kuala Lumpur, Malaysia  
Phone: 60-3-2070-5141 Fax: 60-3-2070-5148

#### Jakarta Office

12th Floor, Skyline Bldg., Jl. M. H. Thamrin 9, Jakarta 10340, Indonesia  
Phone: 62-21-314-0737 Fax: 62-21-314-1049

## OVERSEAS SUBSIDIARIES

---

### Kawasaki Heavy Industries (U.S.A.), Inc.

599 Lexington Avenue, Suite 3901, New York, NY 10022, U.S.A.  
Phone: 1-212-759-4950 Fax: 1-212-759-6421

#### Houston Branch

333 Clay Street, Suite 4310, Houston, TX 77002-4103, U.S.A.  
Phone: 1-713-654-8981 Fax: 1-713-654-8187

### Kawasaki do Brasil Indústria e Comércio Ltda.

Avenida Paulista 542-6 Andar, Bela Vista, 01310-000, São Paulo, S.P., Brazil  
Phone: 55-11-3289-2388 Fax: 55-11-3289-2788

### Kawasaki Heavy Industries (U.K.) Ltd.

4th Floor, 3 St. Helen's Place, London EC3A 6AB, U.K.  
Phone: 44-20-7588-5222 Fax: 44-20-7588-5333

### Kawasaki Heavy Industries (Europe) B.V.

7th Floor, Riverstaete, Amsteldijk 166, 1079 LH Amsterdam, The Netherlands  
Phone: 31-20-6446869 Fax: 31-20-6425725

### Kawasaki Heavy Industries (H.K.) Ltd.

Room 4211-16, Sun Hong Kai Centre 30 Harbour Road, Wanchai  
Hong Kong People's Republic of China  
Phone: 852-2522-3560 Fax: 852-2845-2905

### Kawasaki Heavy Industries (Singapore) Pte. Ltd.

6 Battery Road, #18-04, Singapore 049909  
Phone: 65-6225-5133~4 Fax: 65-6224-9029