

MAHLE

Driven by performance

Duplex Filter

Pi 4700

Nominal pressure up to 315/350 bar (4570/4980 psi), nominal size 40 up to 400
according to DIN 24550

1. Features

High performance filters for modern hydraulic systems

- Provided for pipe installation
- Modular system
- Compact design
- Minimal pressure drop through optimal flow design
- Visual/electrical/electronic maintenance indicator
- Threaded connections
- Ergonomic switch-over handle with safety lock user-optimized one-hand-operation
- Quality filters, easy to service
- Equipped with highly efficient glass fibre PS filter elements
- Beta rated elements according to ISO 16889 multipass test
- Elements with high differential pressure stability and dirt holding capacity
- NPT- and SAE-connections on request
- Worldwide distribution

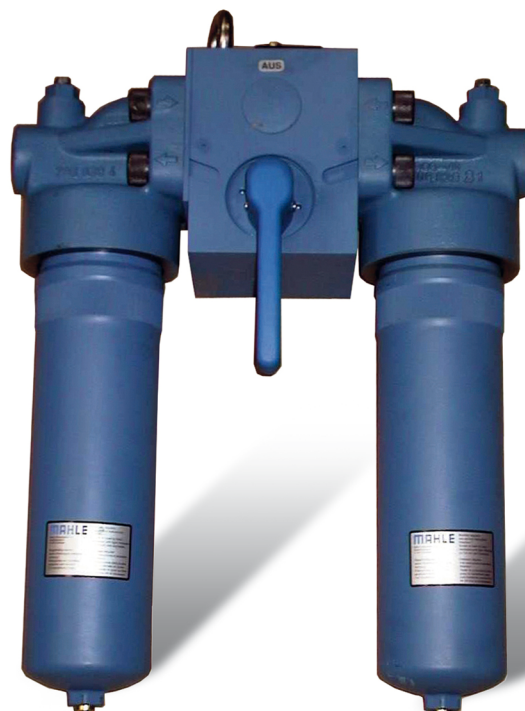

2. Flow rate/pressure drop curve complete filter

190 mm²/s
33 mm²/s

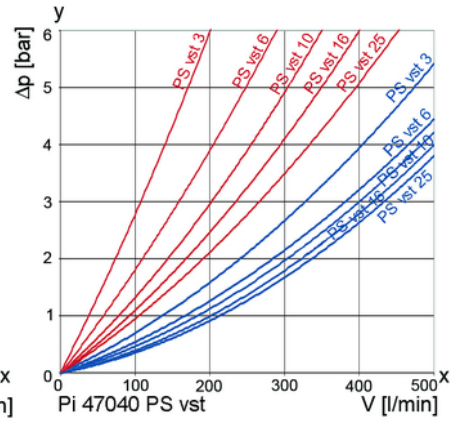
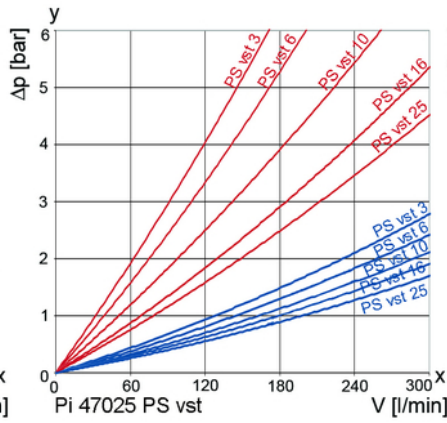
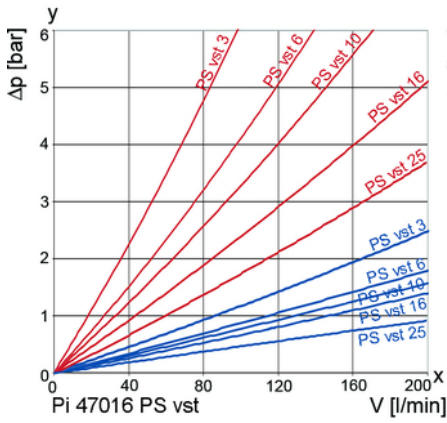
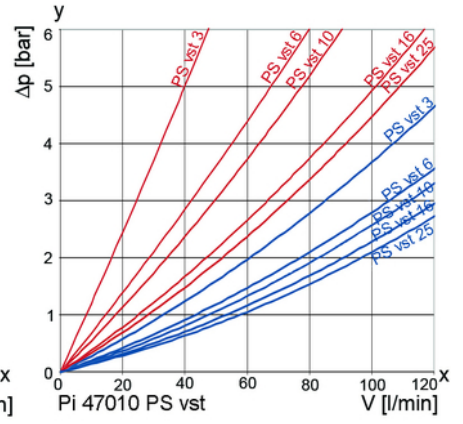
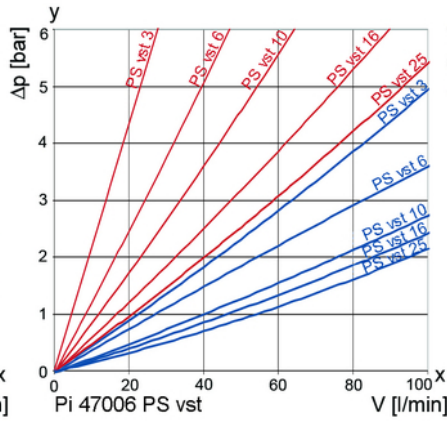
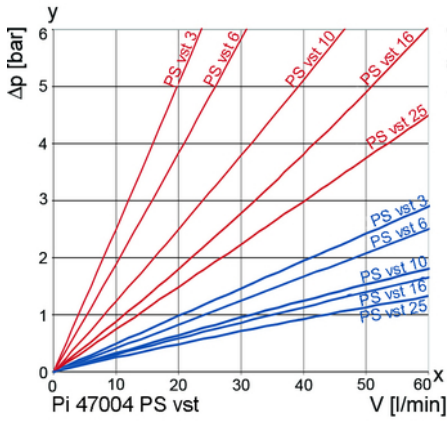

y = differential pressure Δp [bar]

x = flow rate V [l/min]

3. Separation grade characteristics

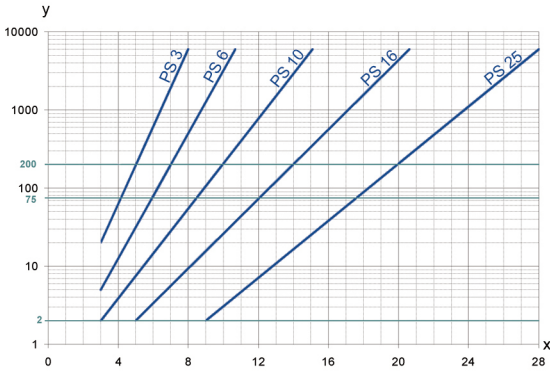

y = beta-value
x = particle size [μm]

determined by multipass tests (ISO 16889)
calibration according to ISO 11171 (NIST)

4. Filter performance data

tested according to ISO 16889 (multipass test)

PS vst elements with
max. Δp 210 bar

PS vst	3	$\beta_{5(C)} \geq 200$
PS vst	6	$\beta_{7(C)} \geq 200$
PS vst	10	$\beta_{10(C)} \geq 200$
PS vst	16	$\beta_{15(C)} \geq 200$
PS vst	25	$\beta_{20(C)} \geq 200$

values guaranteed up to
20 bar differential pressure

5. Quality assurance

MAHLE filters and filter elements are produced according to the following international standards:

Norm	Designation
DIN ISO 2941	Hydraulic fluid power filter elements; verification of collapse/burst resistance
DIN ISO 2942	Hydraulic fluid power filter elements; verification of fabrication integrity
DIN ISO 2943	Hydraulic fluid power filter elements; verification of material compatibility with fluids
DIN ISO 3723	Fluidtechnik-Hydraulik Filterelemente, method for end load test
DIN ISO 3724	Hydraulic fluid power filter elements; verification of flow fatigue characteristics
ISO 3968	Hydraulic fluid power-filters-evaluation of pressure drop versus flow characteristics
ISO 10771.1	Fatigue pressure testing of metal containing envelopes in hydraulic fluid applications
ISO 16889	Hydraulic fluid power filters-multipass method for evaluation filtration performance of a filter element

6. Symbols

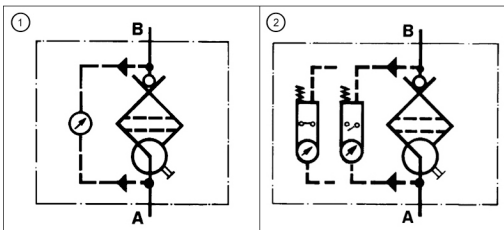

7. Order numbers

Example for ordering filters:

1. Housing design	2. 2x Filter element
V = 100 l/min and visual/electrical maintenance indication Type: Pi 47010-015 Order number: 70304308	PS vst 10 Type: Pi 73010 DN PS vst 10 Order number: 77925670

7.1 Housing design

Nominal size NG [l/min]	Order number	Type	with indicator cavity	① with visual indication	② with electrical indication
40	70304318	Pi 47004-010			
	70304300	Pi 47004-014			
	70304306	Pi 47004-015			
63	70304319	Pi 47006-010			
	70304301	Pi 47006-014			
	70304307	Pi 47006-015			
100	70304320	Pi 47010-010			
	70304302	Pi 47010-014			
	70304308	Pi 47010-015			
160	70304338	Pi 47016-010			
	70304340	Pi 47016-014			
	70304341	Pi 47016-015			
250	70304332	Pi 47025-010			
	70304335	Pi 47025-014			
	70304331	Pi 47025-015			
400	70304333	Pi 47040-010			
	70304336	Pi 47040-014			
	70304337	Pi 47040-015			

When filter with non bypass configuration is selected the max. Δp pressure of the element must not be exceeded.

7.2 Filter elements*

Nominal size NG [l/min]	Order number	Type	Filter material	max. Δp [bar]	Filter surface [cm ²]
40	78216079	Pi 71004 DN PS vst 3	PS vst 3	210	445
	77960156	Pi 72004 DN PS vst 6	PS vst 6		
	77925654	Pi 73004 DN PS vst 10	PS vst 10		
	78216087	Pi 74004 DN PS vst 16	PS vst 16		
	78216095	Pi 75004 DN PS vst 25	PS vst 25		
63	78216137	Pi 71006 DN PS vst 3	PS vst 3		
	77960149	Pi 72006 DN PS vst 6	PS vst 6		
	77925662	Pi 73006 DN PS vst 10	PS vst 10		
	78216145	Pi 74006 DN PS vst 16	PS vst 16		
	78216152	Pi 75006 DN PS vst 25	PS vst 25		
100	78227480	Pi 71010 DN PS vst 3	PS vst 3		
	77960131	Pi 72010 DN PS vst 6	PS vst 6		
	77925670	Pi 73010 DN PS vst 10	PS vst 10		
	78261281	Pi 74010 DN PS vst 16	PS vst 16		
	78216160	Pi 75010 DN PS vst 25	PS vst 25		

*a wider range of element types is available on request

7.2 Filter elements*

Nominal size NG [l/min]	Order number	Type	Filter material	max. Δp [bar]	Filter surface [cm ²]
160	77940638	Pi 71016 DN PS vst 3	PS vst 3	210	1885
	77960123	Pi 72016 DN PS vst 6	PS vst 6		
	77925688	Pi 73016 DN PS vst 10	PS vst 10		
	78269797	Pi 74016 DN PS vst 16	PS vst 16		
	78216178	Pi 75016 DN PS vst 25	PS vst 25		
250	77940646	Pi 71025 DN PS vst 3	PS vst 3	210	3090
	77960115	Pi 72025 DN PS vst 6	PS vst 6		
	77925696	Pi 73025 DN PS vst 10	PS vst 10		
	78269813	Pi 74025 DN PS vst 16	PS vst 16		
	78216186	Pi 75025 DN PS vst 25	PS vst 25		
400	77940653	Pi 71040 DN PS vst 3	PS vst 3	210	5240
	77960107	Pi 72040 DN PS vst 6	PS vst 6		
	77930829	Pi 73040 DN PS vst 10	PS vst 10		
	78269821	Pi 74040 DN PS vst 16	PS vst 16		
	78260903	Pi 75040 DN PS vst 25	PS vst 25		

* a wider range of element types is available on request

8. Technical specifications

Design:	line mounting filter
Nominal pressure: Pi 47016-47040	315 bar (4480 psi)
Pi 47004-Pi 47010	350 bar (4980 psi)
Test pressure: Pi 47016-47040	410 bar (5830 psi)
Pi 47004-Pi 47010	455 bar (6470 psi)
Temperature range:	-10 °C to +120 °C (other temperature ranges on request)
Filter head material:	St
Filter housing material:	St
Sealing material:	NBR/PTFE
Maintenance indicator setting:	Δp 5 bar \pm 10 %
Electrical data of maintenance indicator:	
Max. voltage:	250 V AC/200 V DC
Max. current:	1 A
Contact load:	70 W
Type of protection:	IP 65 in inserted and secured status
Contact:	normally open/closed
Cable sleeve:	M20x1.5

The switching function can be changed by turning the electric upper part by 180° (normally closed contact or normally open contact). The state on delivery is a normally closed contact. By inductivity in the direct current circuit the use of suitable protection circuit should be considered. Further maintenance indicator details and designs are available in the maintenance indicator data sheet.

We draw attention to the fact that all values indicated are average values and do not always occur in specific cases of application. Our products are continually being further developed. Values, dimensions and weights can change as a result of this. Our specialized department will be pleased to offer you advice.

We recommend you to contact us concerning applications of our filters in areas governed by the EU Directive 94/9 EC (ATEX 95). The standard version can be used for liquids based on mineral oil (corresponding to the fluids in Group 2 of Directive 97/23 EC Article 9). If you consider to use other fluids please contact us for additional support.

Subject to technical alteration without prior notice.

9. Dimensions

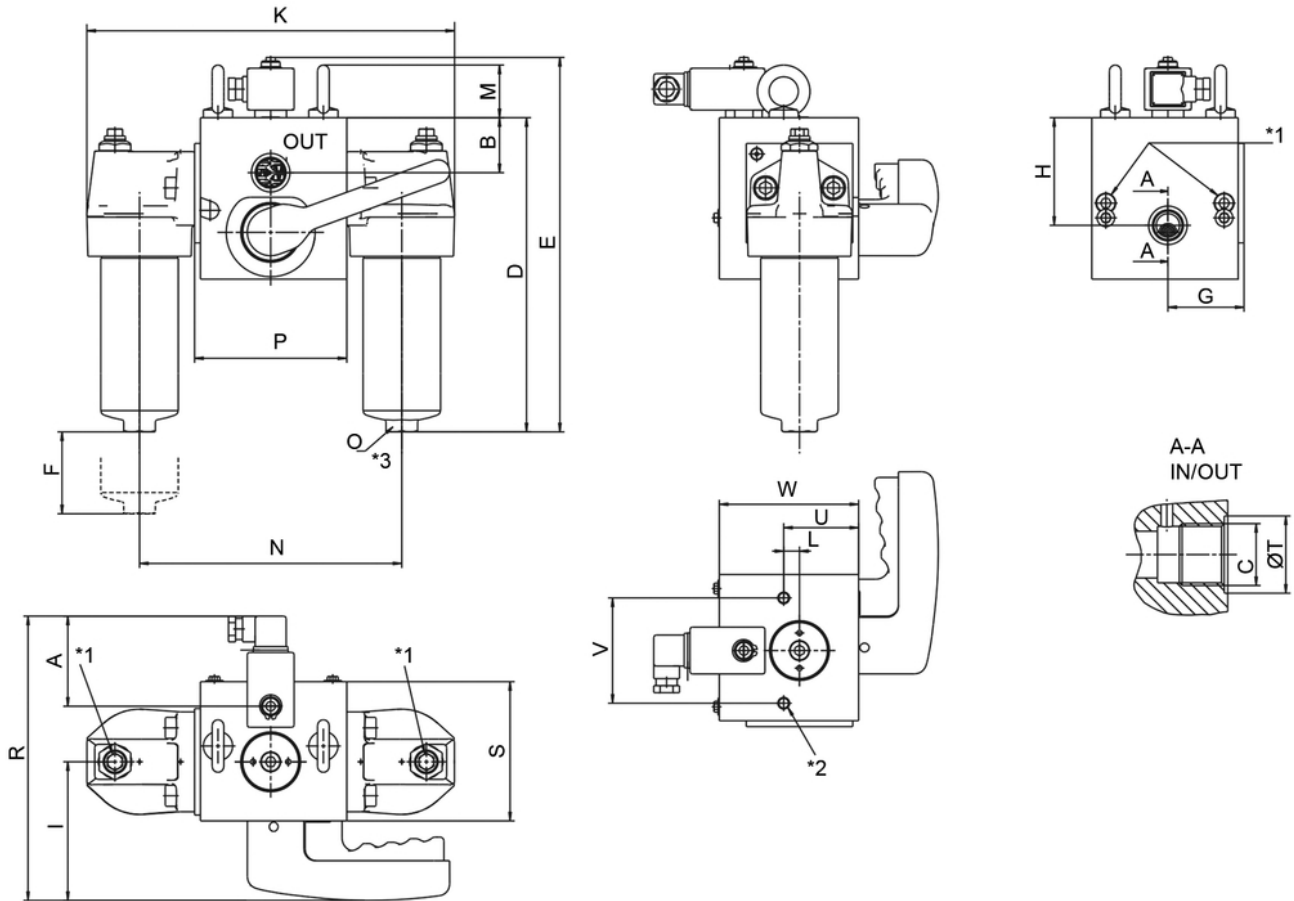

*1 Vent screw

*2 Mounting cavity

*3 Drain screw Pi 47016 up to Pi 47040

M10x20 for Pi 47004 up to Pi 47010
M16x20 for Pi 47016 up to Pi 47040

All dimensions except "C" in mm.

Type	A	B	C	D	E	F	G	H	I	K	L
Pi 47004	78	47	G¾	269	320	110	65	92	119	314	14
Pi 47006	78	47	G¾	347	398	110	65	92	119	314	14
Pi 47010	78	47	G¾	423	474	110	65	92	119	314	14
Pi 47016	78	53	G1½	334	396	110	75	125	135	450	23
Pi 47025	78	53	G1½	424	486	110	75	125	135	450	23
Pi 47040	78	53	G1½	574	636	110	75	125	135	450	23

Type	M	N	O	P	R	S	T	U	V	W	Weight [kg]
Pi 47004	45	224	SW27	130	243	119	33	64	90	119	22
Pi 47006	45	224	SW27	130	243	119	33	64	90	119	23
Pi 47010	45	224	SW27	130	243	119	33	64	90	119	25
Pi 47016	62	300	SW30	150	271	150	65	90	100	150	56
Pi 47025	62	300	SW30	150	271	150	65	90	100	150	61
Pi 47040	62	300	SW30	150	271	150	65	90	100	150	66

10. Installation, operating and maintenance instructions

10.1 Filter installation

Install filter in accordance with the identified flow direction. The filter head is provided with threaded holes for mounting the filters. Ascertain that the required clearance is provided so that the filter element and the filter housing can be removed. Preferably the filter should be installed with the filter housing pointing downwards. The maintenance indicator must be visible.

10.2 Connecting the electrical maintenance indicator

The electrical indicator is connected via a 2-pole appliance plug according to DIN EN 175301-803 with poles marked 1 and 2. The electrical section can be inverted to change from normally open to normally closed position or vice versa.

10.3 When should the filter element be replaced?

1. Filters equipped with visual and electrical maintenance indicator: During cold starts, the indicator may give a warning signal. Press the red button of the visual indicator once again only after operating temperature has been reached. If the red button immediately pops up again and/or the electrical signal has not switched off after reaching operating temperature the filter element must be replaced after the end of the shift.
2. Filters without maintenance indicator:
The filter element should be replaced after the trial run or flushing of the system. Afterwards follow instructions of the manufacturer.
3. Please always ensure that you have original MAHLE spare elements in stock: Disposable elements (PS) cannot be cleaned.

10.4 Element replacement

Note: Elements may only be replaced by people who are familiar with the function of the filter. When replacing elements, appropriate safety clothing (protective goggles, gloves, safety shoes) must be worn

Note: The maintenance indicator monitors the filter side in operation, which is identified by the position of the switching lever catch. The change-over transfer valve must be switched prior filter servicing. Now the signal of the contamination indicator is cancelled and the red button can be repressed again:

1. Operate and hold pressure equalizing lever located behind switching lever. Pull catch knob and swivel switching lever. Engage the catch on the clear filter side. Place through or drip pan underneath to collect leaving oil.
2. Loosen vent screw of the filter side not in use by 2 to 3 turns.
3. Unscrew filter housing by turning counter-clockwise. Clean the housing using a suitable cleaning solvent.

Warning: The shift lever may not, from now until the screwing back in of the filter housing (7.), be activated under any circumstances!

4. Remove filter element by pulling down carefully.
5. Check O-ring on the filter housing for damage. Replace, if necessary.
6. Make sure that the order number on the spare element corresponds to the order number of the filter name-plate. Open the plastic bag and push element over the spigot in the filter head. Now remove plastic bag.
7. Lightly lubricate the threads of the filter housing and screw into the filter head. Maximum tightening torque for NG 40 to 100 = 60 Nm, for NG 160 to 400 = 100 Nm.
8. To refill the filter chamber, operate only the pressure equalizing lever (leave the switching lever arrested in its catch) long enough for the medium to emerge bubble-free from the vent bore.
9. Tighten vent screw. Check filter for leaks by operating the pressure equalizing lever once again.

11. Spare parts

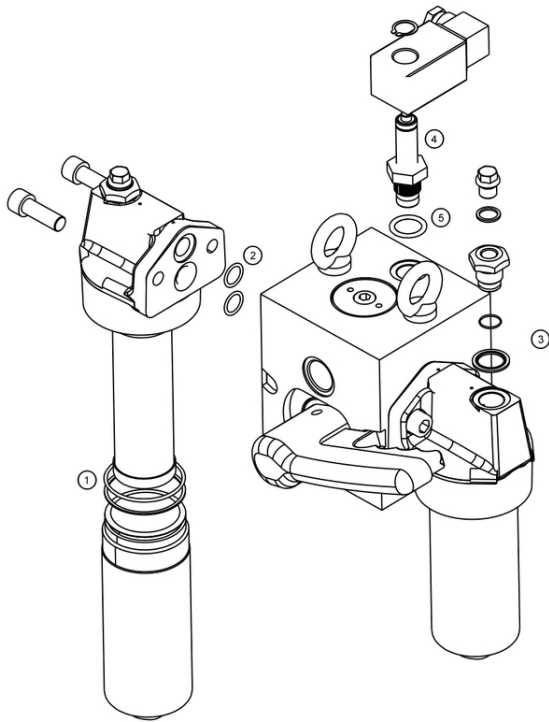

Order number for spare parts		
Position	Type	Order number
① - ③	Seal kit for housing	
	Pi 47004-47010	
	NBR	70304944
	FPM	70304945
	EPDM	70304946
	Pi 47016-47040	
	NBR	70304922
	FPM	70304924
	EPDM	70304925
④	Maintenance indicator	
	Visual PiS 3093/5	77669914
	Electrical PiS 3092/5	77669864
	Electrical upper part only	77536550
⑤	Seal kit for maintenance indicator	
	NBR	77760275
	FPM	77760283
	EPDM	77760291

MAHLE Industriefiltration GmbH
 Schleifbachweg 45
 D-74613 Öhringen
 Phone +49 7941 67-0
 Fax +49 7941 67-23429
 industrialfiltration@mahle.com
 www.mahle.com
 70349845.04/2015