

Mesur-Fil[®] Fluid Couplings



Wichita Clutch

Wichita Clutch, founded in 1949, is a leading global designer and manufacturer of heavy-duty clutches and brakes that are essential components in industrial process equipment. Backed by extensive application experience, Wichita engineers utilize the latest design technologies and materials to provide innovative clutch and brake solutions that precisely meet their customer's most demanding requirements.

A full range of Wichita solutions, including hydraulic clutches and brakes, air clutches, air brakes, water-cooled clutches and brakes, and fluid couplings, are used extensively around the world by major OEMs in metalworking, steel, marine, pulp & paper, material handling, mining, and energy.

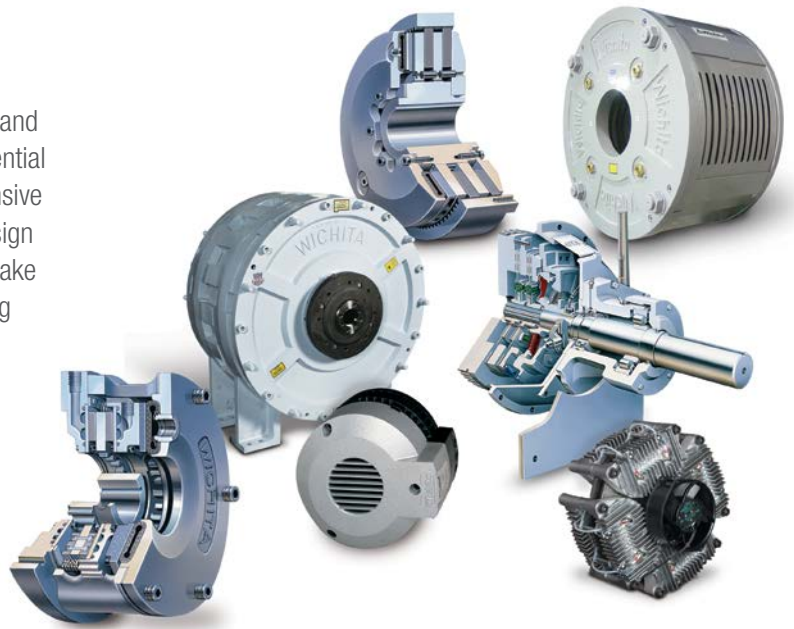

VISIT US ON THE WEB AT
WWW.WICHITACLUTCH.COM

Altra Industrial Motion

Altra is a leading global designer and manufacturer of quality power transmission and motion control products utilized on a wide variety of industrial drivetrain applications. Altra clutches and brakes, couplings, gearing and PT component product lines are marketed under the industries most well known manufacturing brands. Each brand is committed to the guiding principles of operational excellence, continuous improvement and customer satisfaction. Highly-engineered Altra solutions are sold in over 70 countries and utilized in a variety of major industrial markets, including food processing, material handling, packaging machinery, mining, energy, automotive, primary metals, turf and garden and many others.

Altra's leading brands include **Ameridrives**, **Bauer** Gear Motor, **Bibby** Turboflex, **Boston** Gear, **Delroyd** Worm Gear, **Formsprag** Clutch, **Guardian** Couplings, **Huco**, **Industrial** Clutch, **Inertia** Dynamics, **Kilian**, **Lamiflex** Couplings, **Marland** Clutch, **Matrix**, **Nuttall** Gear, **Stieber**, **Stromag**, **Svendborg** Brakes, **TB Wood's**, **Twiflex**, **Warner** Electric, **Warner** Linear and **Wichita** Clutch.

VISIT US ON THE WEB AT ALTRAMOTION.COM





12.4 HCM

9.4 HBM

7.0 HSD

Mesur-Fil® Fluid Couplings

Wichita Mesur-Fil Fluid Couplings

Wichita Mesur-Fil Fluid Couplings deliver reliable smooth power transmission. To consistently deliver, we select only from the highest quality materials. Our manufacturing and product assembly are completed under the most exacting guidelines and established procedures. The result is unquestioned consistent product dependability.

Mesur-Fil Fluid Couplings are rated for motors up to 50 HP. They have earned a reputation for providing smooth, soft starts while reducing current draw on the motor by 33%.

Mesur-Fil Fluid Couplings are ideally suited for direct drive applications between electric motors and gear boxes.

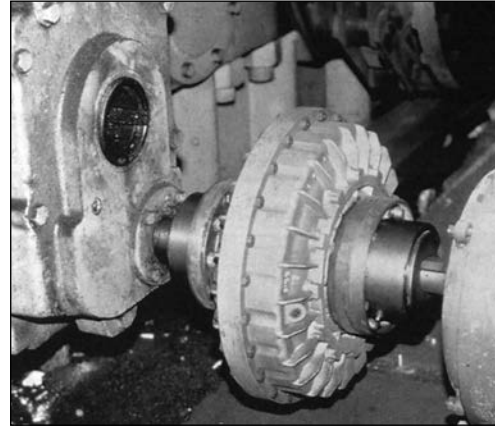

Typical Applications

Bulk Material Handling Equipment and Mining Related Industries:

- Conveyors of all types
- Crushers
- Excavators
- Fans
- Mills
- Mixers
- Pumps
- Screening Plants

Petrochem and Chemical Processing:

- Agitators
- Blowers/Fans
- Centrifuges
- Compressors
- Mixers
- Pumps

Other Applications include:

- Amusement park rides
- Construction
- Machine tools
- Oil Field
- Power Generation
- Ski resort chair lifts

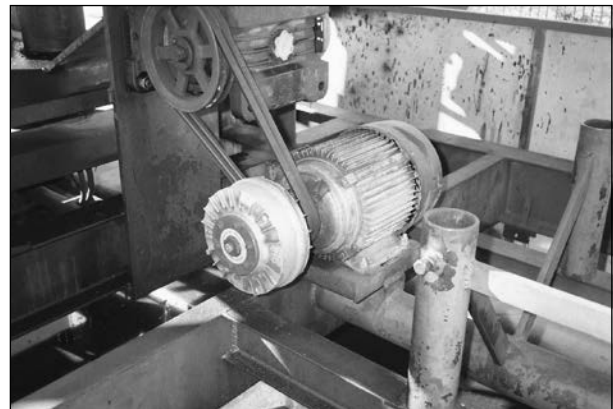

Mesur-Fil 7.0 HSD allows shock-free acceleration on large inertia loads.

Picture Courtesy of Torpey Denver, Inc.

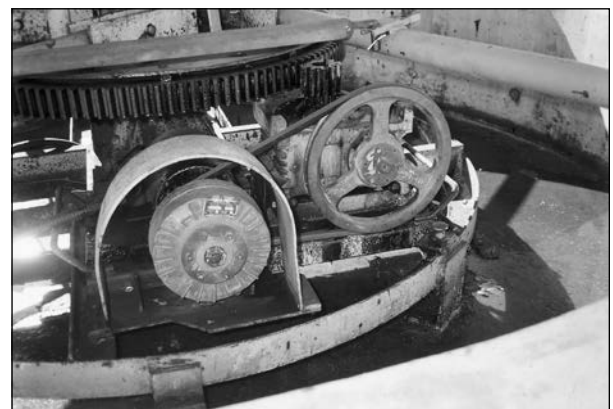

Mesur-Fil 7.0 HSD on amusement park ride, "Speed Boats," giving cushioned, smooth starts.

Picture Courtesy of Torpey Denver, Inc.

Design Advantages

Mesur-Fil Fluid Couplings allow motors to start unloaded and to reach operating speed with smooth, controlled acceleration. This makes it ideal for applications with high inertia loads. They are available in either constant or delay fill versions.

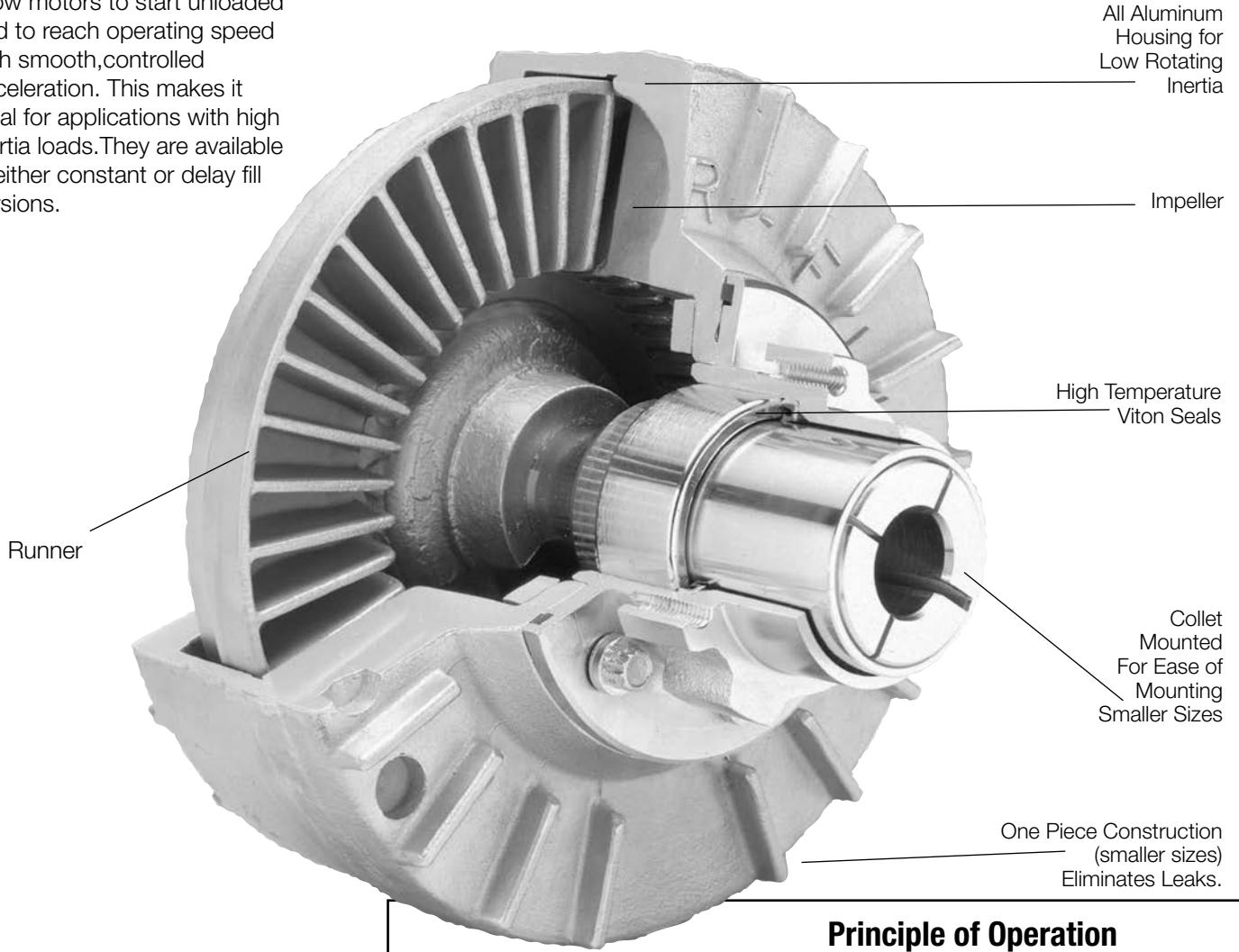

Benefits

Mesur-Fil Fluid Couplings offer several advantages:

- Reduced energy consumption
- Jam/overload protection
- Shock load cushioning
- No metal-to-metal contact
- Wide range of available mounting options
- High temperature Viton seals
- Available from over 700 Formsprag Authorized Distributors.

Principle of Operation

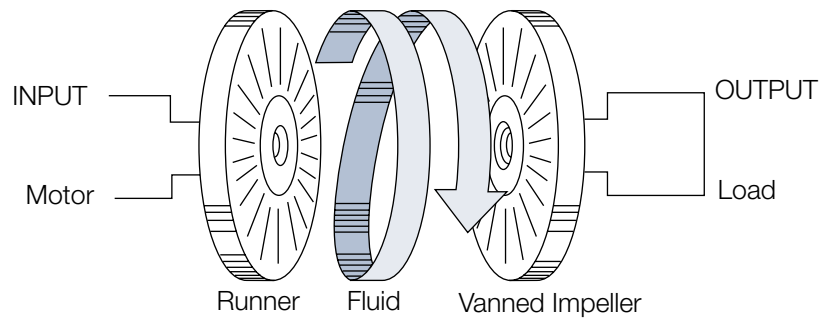

There are three primary components to Mesur-Fil Fluid Couplings:

1. Vanned runner
2. Vanned impeller
3. Fluid fill

Torque, produced by the prime mover (motor) acting on a vanned runner, is transmitted through the flow of fluid into

the chambers formed by the two coupling halves. The oil (fluid) is subsequently thrown into the vanned impeller connected to the load causing it to turn. It is important to note, that as this transmission of power takes place, there is virtually no wear on the transmitting parts because there is no mechanical contact between them.

Mesur-Fil® Fluid Couplings

Fluid Requirements

Figure 2 reveals a typical NEMA B electric motor torque curve together with the particular operating characteristics of a specific coupling with a designated fill level. With no power supplied, all of the fluid is settled at the bottom of the coupling. Slip rate in this condition is 100% with the input free to turn. With the motor starting and increasing in speed to the breakdown point, torque builds in the coupling. As torque increases, the coupling begins to deliver the load to the motor, eventually bringing the load up to speed (refer to the load acceleration area in Figure 2).

The area on the chart between the motor torque curve and the 100% slip curve represents the excess torque available to the motor to start itself without also having to start the load. It is this operating characteristic which permits a soft start with a one third lower current draw on the motor (see Figure 3). (It should be noted that because the coupling torque can only be developed if the runner is turning at a slower speed than the impeller, an ideal small amount of slip of 3% to 5% is necessary). The Mesur-Fil Fluid Coupling provides for jam load protection to the motor and other vital power system components. It is designed to allow the motor to decelerate only to its breakdown point (see Figure 4). The results without the fluid coupling could be a locked rotor condition, resulting in excessive current draw and potential motor damage. Additionally, the coupling distributes the shock of an overload over a longer time span, thus reducing the possibility of damage.

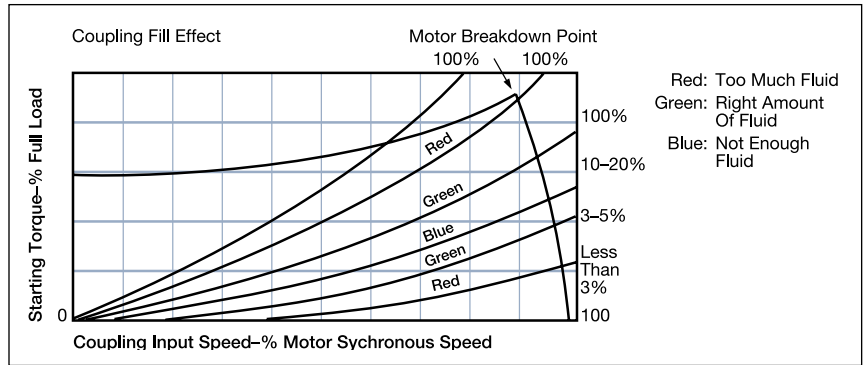

Figure 1 - Motor Breakdown Points

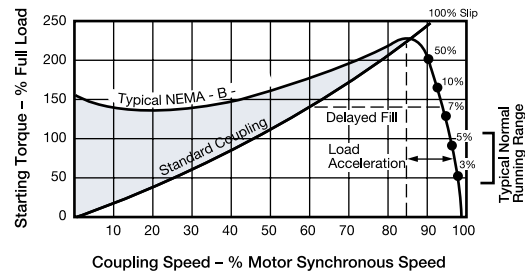

Figure 2 - Starting Torque

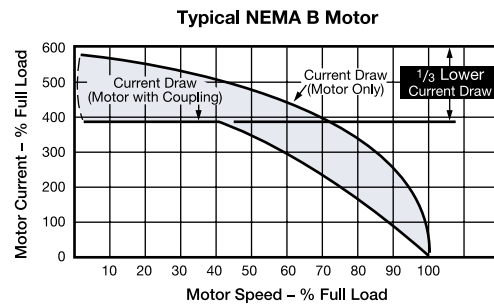

Figure 3 - Start-up Burnout Protection

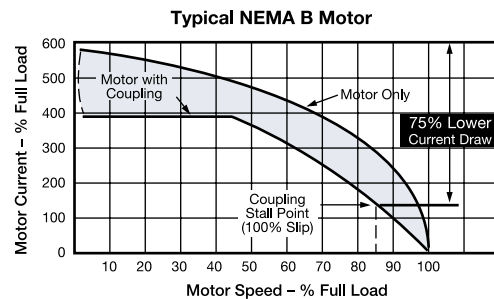

Figure 4 - Jam Load Burnout Protection

Mounting Types per Size

| Mounting Type | 7.0* | 9.4* | 12.4* | Mounting Application |
|---|------|------|-------|---|
| HC (Refer to P-1100-WC, page 168) | ● | ● | ● | Basic coupling for custom input & output |
| HCM (Refer to P-1100-WC, pages 170-171) | ● | ● | ● | For use with flexible gear couplings |
| HBM (Refer to P-1100-WC, page 169) | ● | ● | ● | Shaft to shaft applications For stub shaft input/output sizes 7-12.4 |
| HSD (Refer to P-1100-WC, pages 172-173) | ● | ● | ● | Parallel, QD sheave application |

*Modular design (See page 167)

Modular Design Concept

Sizes 7.0, 9.4, 12.4

Configuration

HCF

Double Engagement Gear Tooth Flexible Coupling

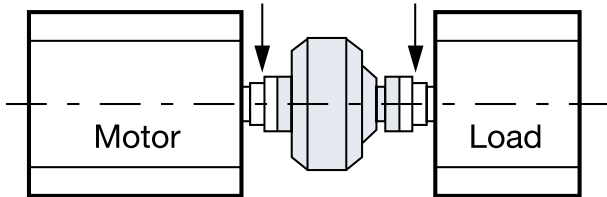

Consists of Model HC and input group. The input group is finish bored to fit standard NEMA B motor shafts. The optional output groups available (HCM, HBM) are shown on this page or the HCF output group must be supplied by the customer. Consult engineering for details.

HCM

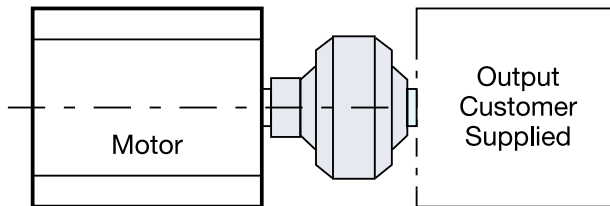

The Model HCM Fluid Coupling is a complete unit with both input and output flanges. It is intended for installation between two halves of a double engagement gear tooth flexible coupling which is customer supplied.

HBM Sizes

Standard Piloting Type Flexible Coupling

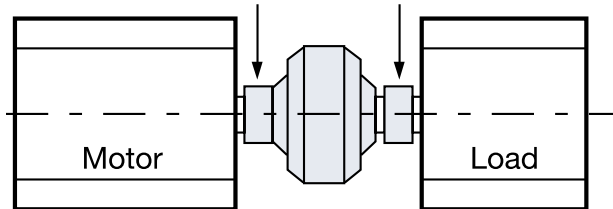

This coupling is a complete unit with a straight input and output shaft. It is installed between two piloting type flexible couplings supplied by the customer.

HSD

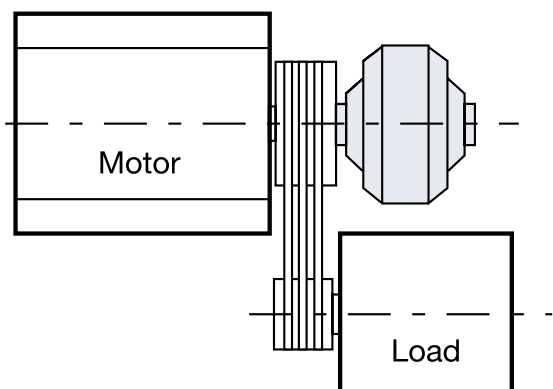

The Model HSD Fluid Coupling consists of a basic fluid coupling, input and output group, and a standard customer supplied QD type sheave. Hydro-sheave couplings provide minimal overhung loads for parallel (belt-driven) applications. The sheave is mounted on a coupling installed on the end of a drive shaft.

Mesur-Fil Couplings can be installed very quickly and easily utilizing a slotted collet for mounting on the motor shaft instead of the center bolt that is most commonly used with other sheave drives. Unlike the center bolt, the slotted collet requires no drilling and tapping of the end of the motor shaft. The slotted collet is finished bored to fit standard NEMA B motor shaft dimensions. Available bore sizes are found elsewhere in this brochure.

Mesur-Fil® Fluid Couplings

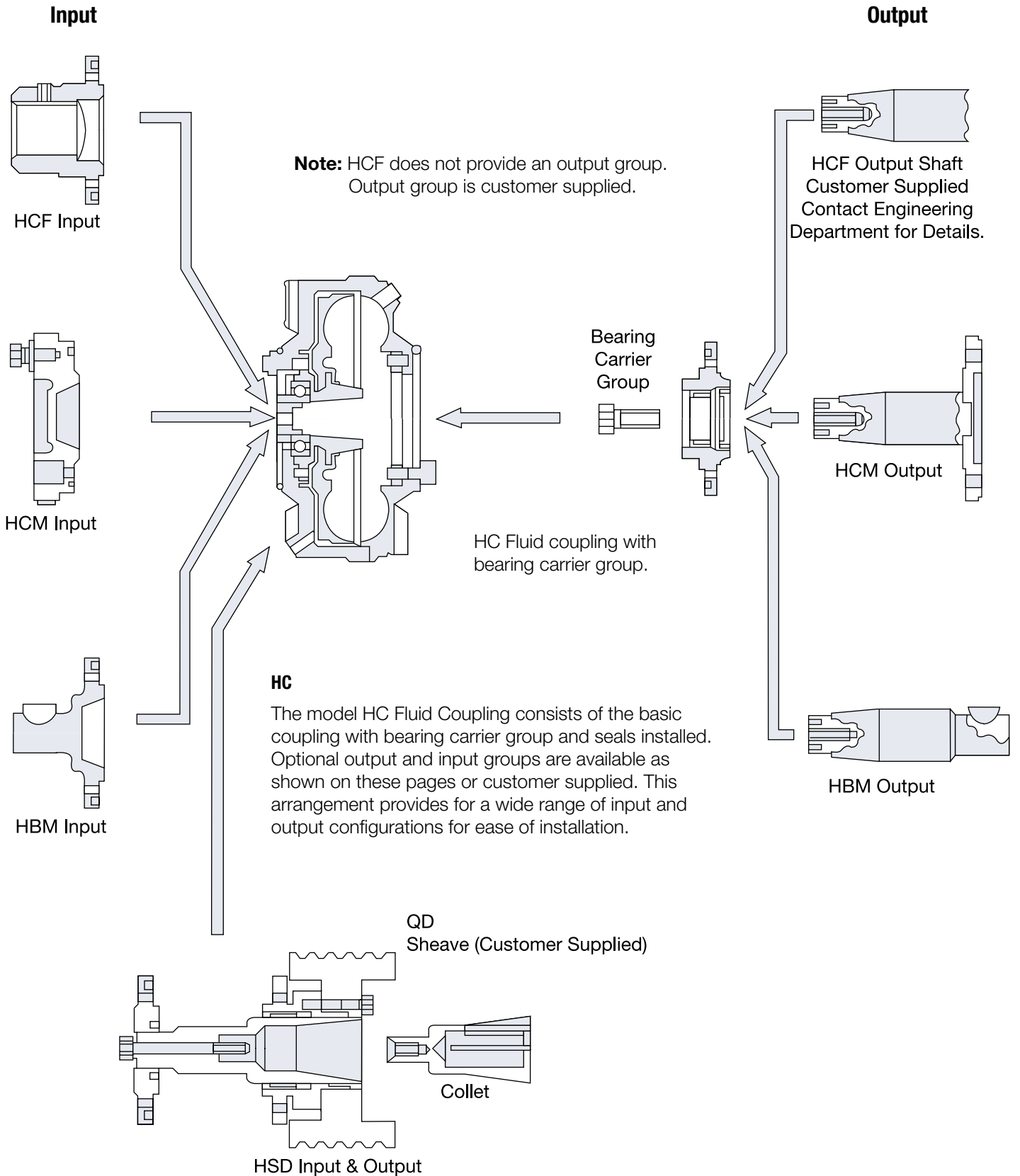

Selection and Sizing

Fill Levels (NEMA B Motors)

The Quick Selection Chart (see Figure 8) provides the correct size coupling and fill level for any standard NEMA B motor within the Mesur-Fil range. It also provides the slip rate that can be anticipated at normal operating speed. Having the correct amount of oil in the coupling is extremely critical to ensure safe and proper operation. Figure 9 shows the effects of either too much or too little fluid. With an optimum amount of fluid, the breakdown point of the motor with the 100% slip line of the coupling provide the best combination of soft start with slip rate at normal speed. With too much fluid (red area), the slip rate is lower and the start is harder. With too little fluid (blue area), the start will be softer but the slip rate will be much higher. This can cause heat dissipation problems, and, in extreme situations, the coupling may completely fail to move the load.

A choice of fluids is also available. In a normal environment, petroleum oil is the best fluid to use. For hazardous conditions such as those encountering dust, paint spray, etc., a special fire-resistant fluid may be required.

Figure 8 - Quick Selection Chart

| HP | 1200 RPM | | | 1800 RPM | | | HP | KW |
|-------|------------|----------|--------|------------|----------|--------|-------|------|
| | Cplg. Size | Fill No. | % Slip | Cplg. Size | Fill No. | % Slip | | |
| 1/2 | 7.0 | 12 | 6 | 7.0 | 8 | 3 | 1/2 | 0.38 |
| 3/4 | 9.4 | 8 | 3 | 7.0 | 8 | 4 | 3/4 | 0.56 |
| 1 | 9.4 | 8 | 3 | 7.0 | 9 | 4 | 1 | 0.75 |
| 1 1/2 | 9.4 | 8-1/2 | 3 | 7.0 | 11 | 5 | 1-1/2 | 1.1 |
| 2 | 9.4 | 9 | 4 | 7.0 | 12 | 6 | 2 | 1.5 |
| 3 | 9.4 | 10 | 5 | 9.4 | 8 | 2 | 3 | 2.2 |
| 5 | 12.4 | 7 | 3 | 9.4 | 8-1/2 | 3 | 5 | 3.8 |
| 7 1/2 | 12.4 | 8 | 2-1/2 | 9.4 | 9 | 3 | 7-1/2 | 5.6 |
| 10 | 12.4 | 9 | 4 | 9.4 | 10 | 4-1/2 | 10 | 7.5 |
| 15 | 12.4 | 11 | 5 | 12.4 | 7 | 3 | 15 | 11.3 |
| | | | | 12.4 | 8 | 2-1/2 | 20 | 15.0 |
| | | | | 12.4 | 8-1/2 | 3 | 25 | 18.8 |
| | | | | 12.4 | 9 | 3-1/2 | 30 | 22.5 |
| | | | | 12.4 | 10 | 4 | 40 | 30.0 |
| | | | | 12.4 | 11 | 5 | 50 | 37.5 |

• **Caution!** 7% or higher slips may cause over-heating if coupling is cycled too rapidly.

For minimum operating temperature below - 10° F, consult the factory.

Note: For vertical mounting order unit with both the standard and optional fill plugs on both sides of the unit.

Figure 9 - Coupling Fill Effect

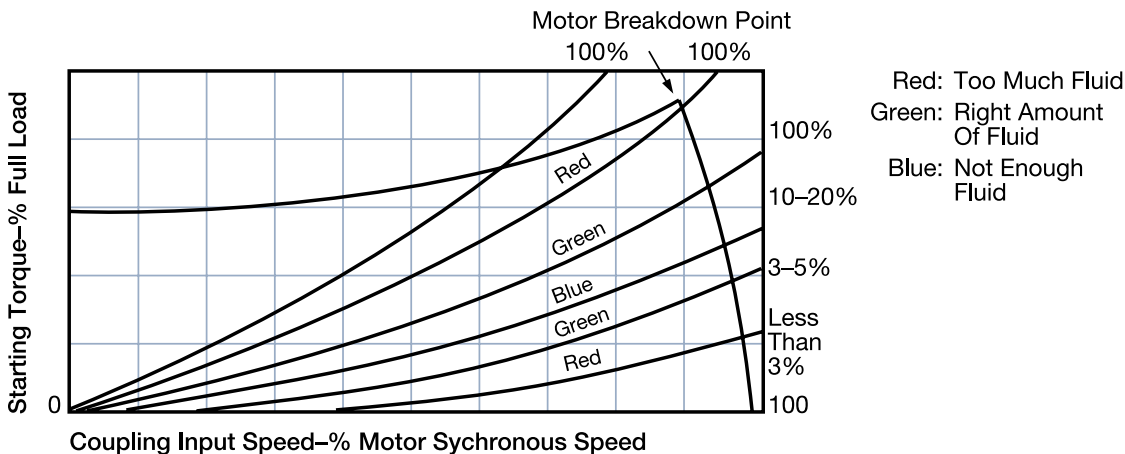

Input Speed vs. Horsepower Graph

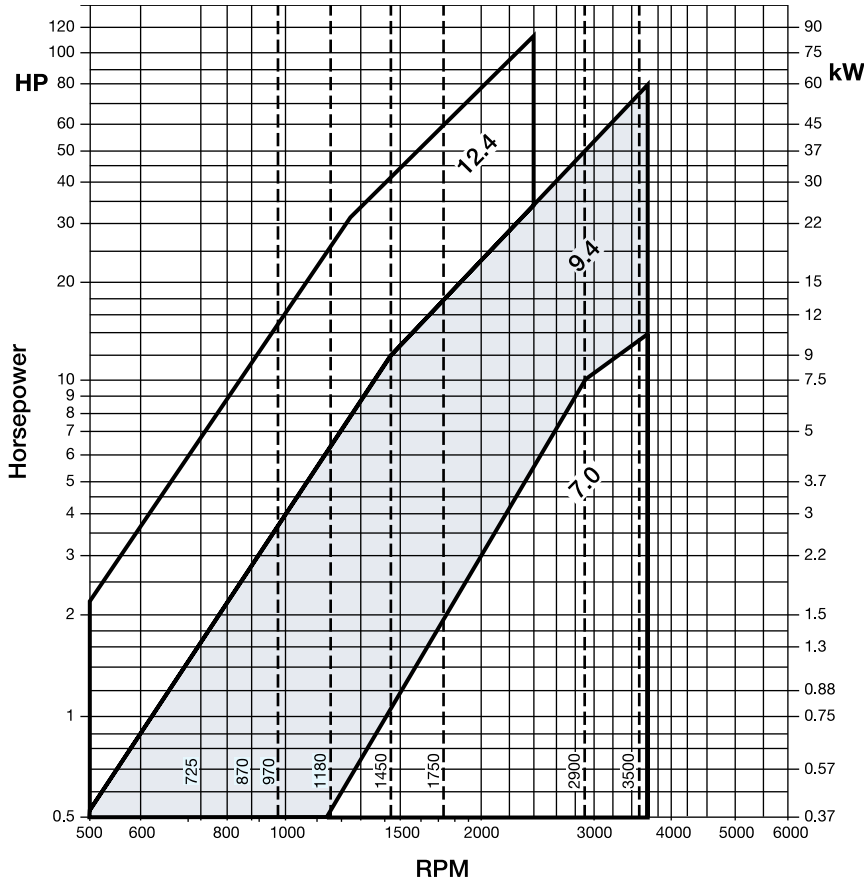

Fluid quantities (fluid oz)

| Fluid Quantities Fill Number | | | | | | |
|------------------------------|------|-----|-----|------|------|-----|
| Size | 7 | 8 | 9 | 10 | 11 | 12 |
| 7.0 | 18.5 | 21 | 23 | 23.5 | 27.6 | |
| 9.4 | 43 | 49 | 54 | 60 | 65 | |
| 12.4 | 87 | 100 | 112 | 125 | 138 | 150 |

Overload Protection

Fusible plug

In overload conditions, as the slip increases and the oil temperature rises, seals become damaged and begin to leak. In order to avoid this damage, in critical applications, it is advisable to install a fusible plug instead of a solid plug. Overload protection. For sizes 7.0 to 12.4 a 250° F fusible plug is available only as an option.

Fluid Recommendation

Oil: SAE 10W

Chevron: Hydraulic Oil EP 32

Esso: Nuto H 32

Mobil: DTE 24

Fire Resistant Fluid

Fyrquel: 220

(Spec. MIL-L-2104 B)

Shell: Tellus 32

Texaco: Rando HD 32

Total: Azolla ZS 32

Slip Curves

Size 7.0

Maximum speed 3,600 RPM (All configurations)

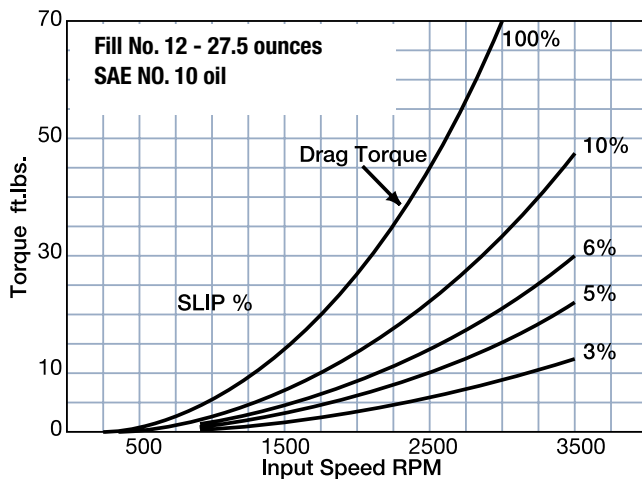
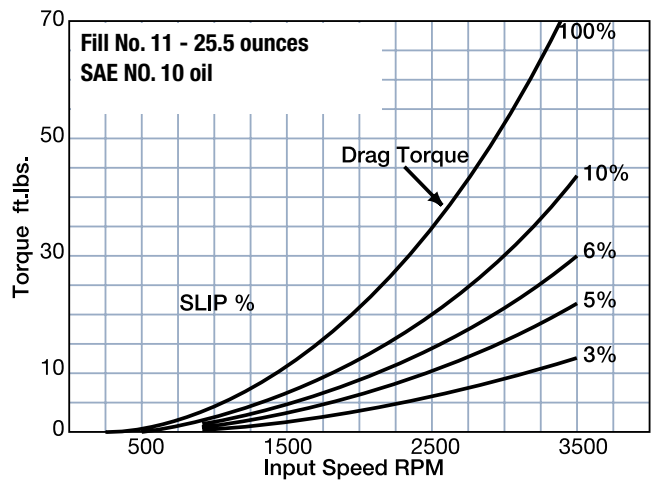
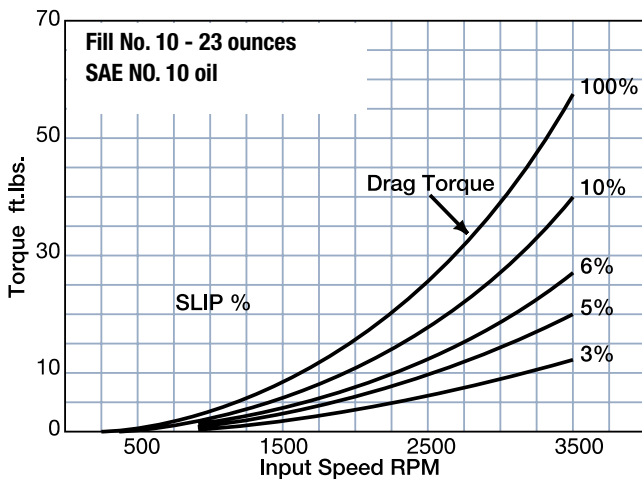
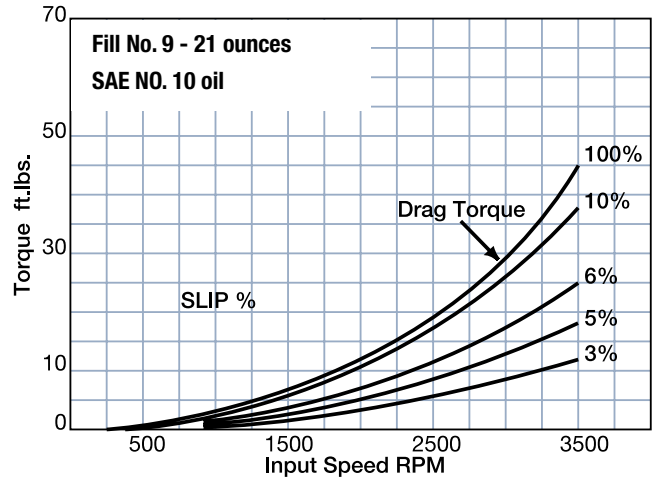
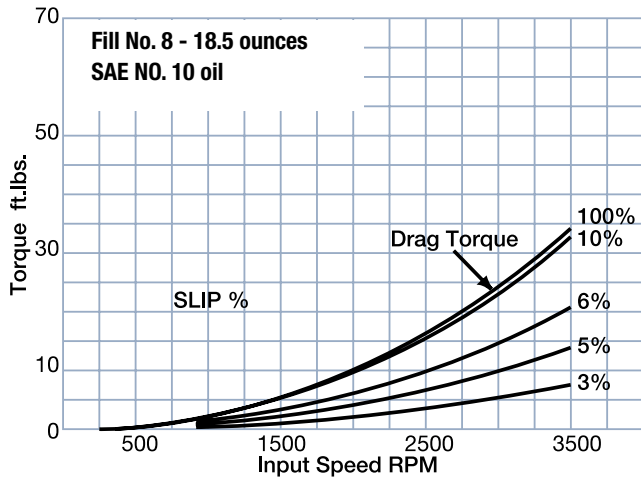

Mesur-Fil® Fluid Couplings

Slip Curves

Size 9.4

Maximum speed 3,600 RPM Except HSD-Max 2,600 RPM

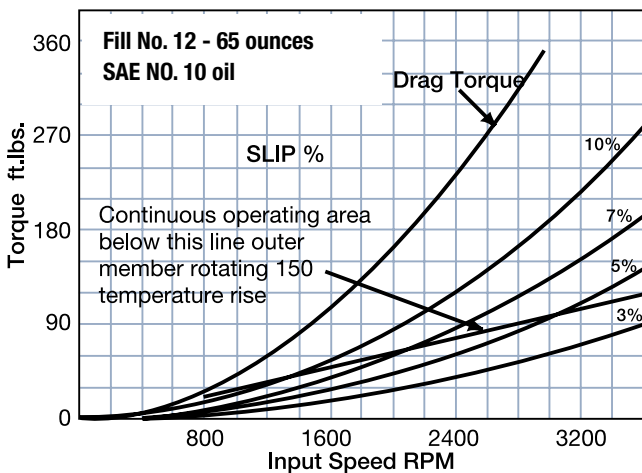
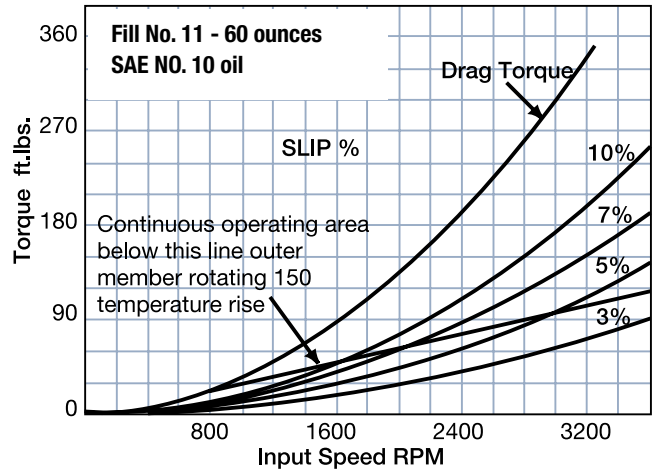
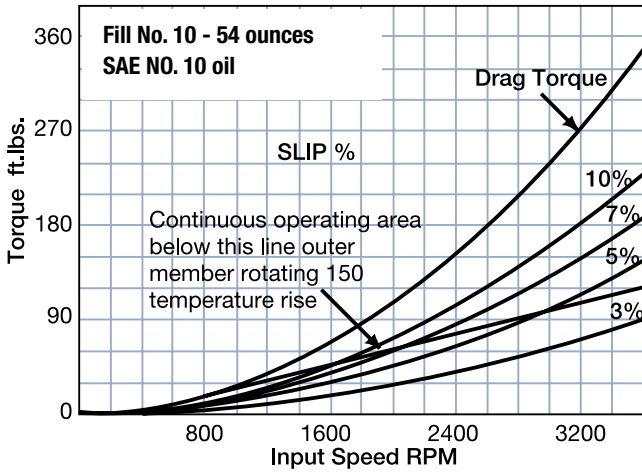
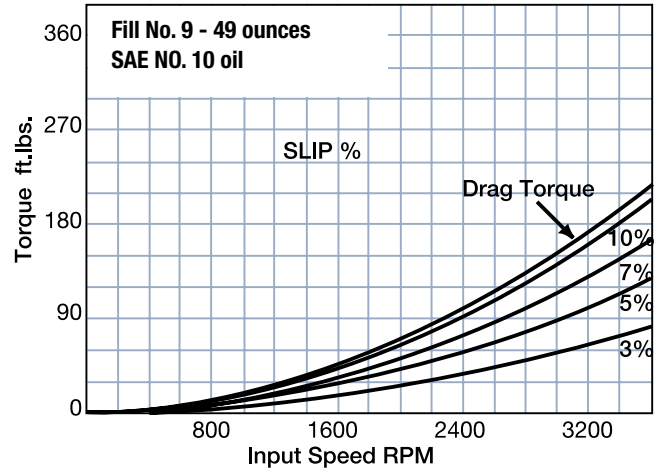
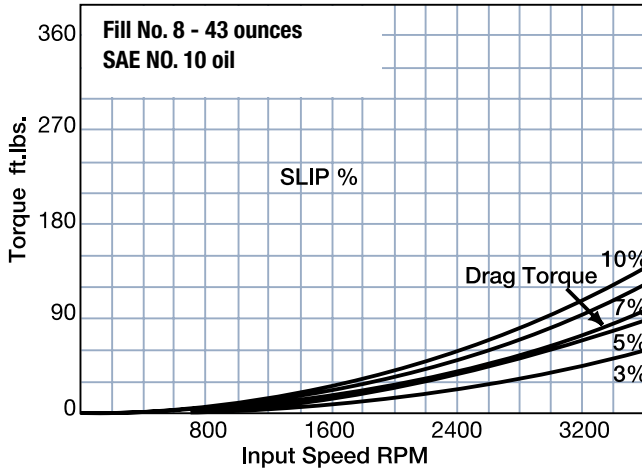

Slip Curves

Size 12.4

Maximum speed 2,400 RPM Except HSD-Max. 1,800 RPM

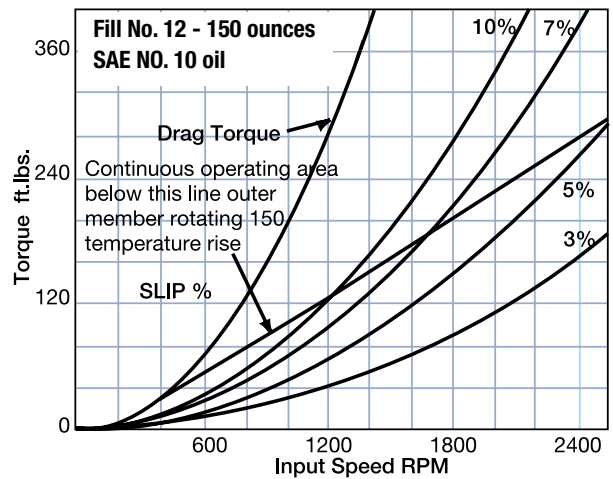
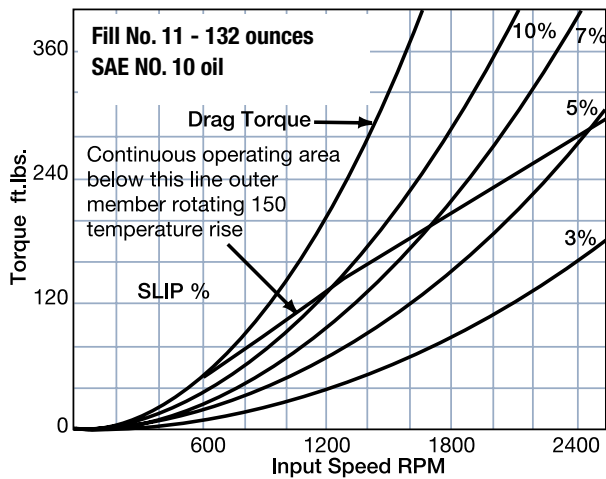
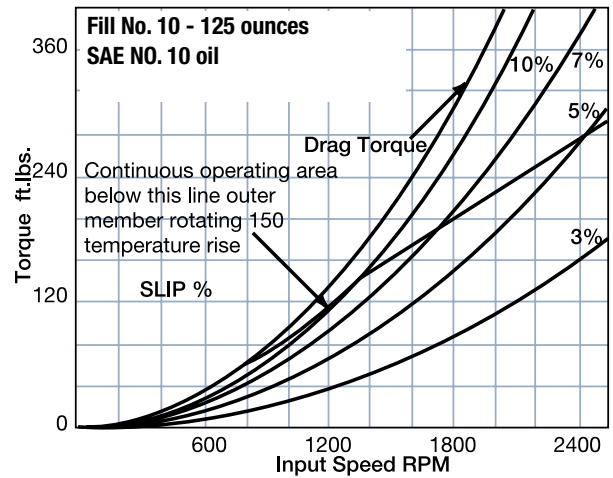
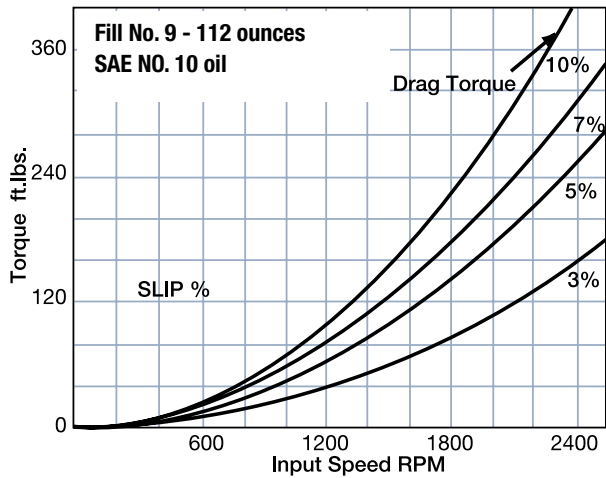
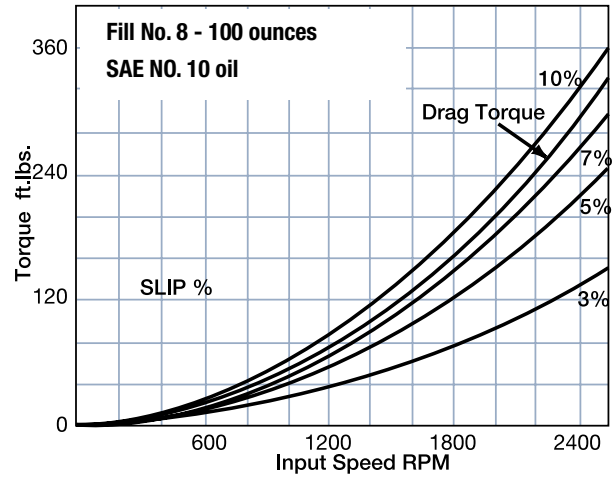
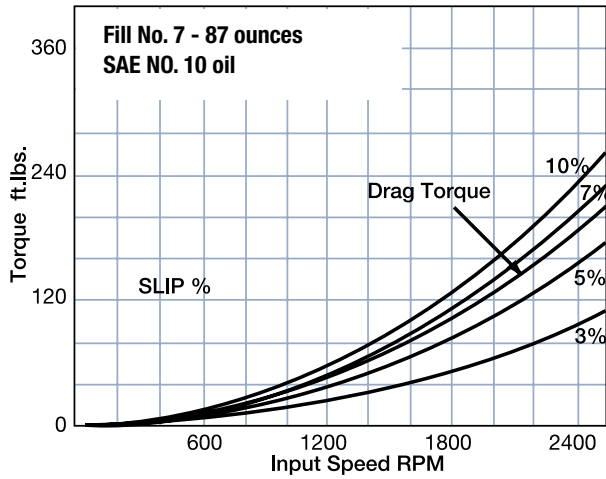

Mesur-Fil® Fluid Couplings

Model HBM (Shaft-to-Shaft Application)

Size 7.0-12.4

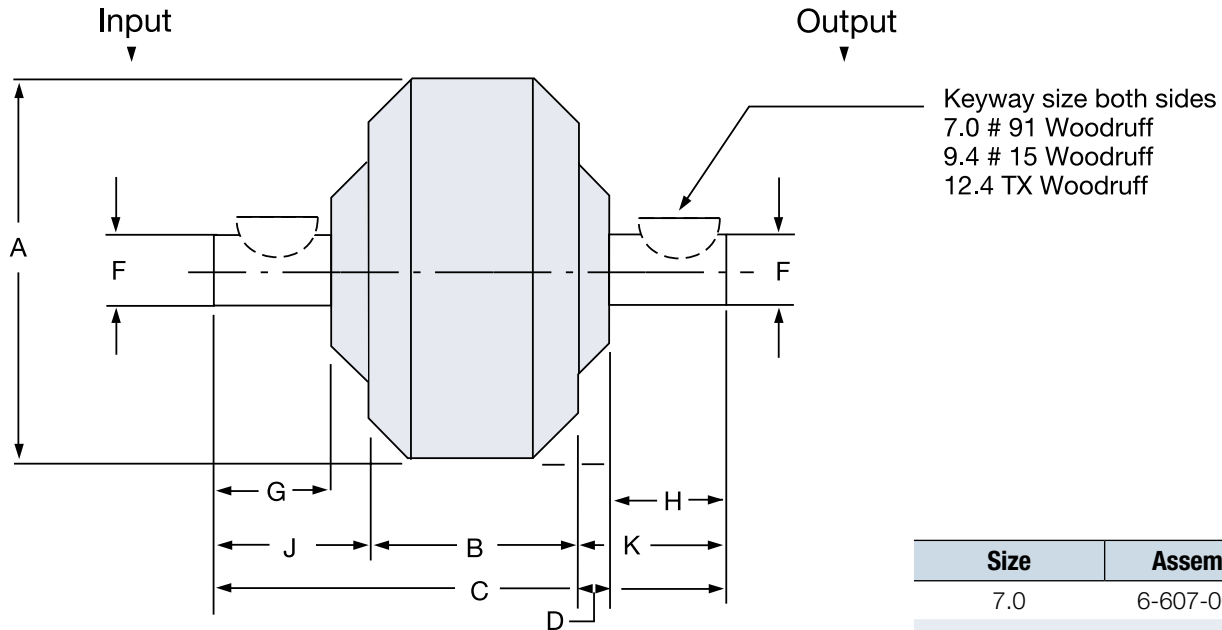

| Size | Assembly Number |
|--------------------------|--------------------|
| 7.0 | 6-607-004-000-0000 |
| 9.4 | 6-609-004-000-0000 |
| 12.4 | 6-612-004-000-0000 |
| 3/8" NPT Fusible Plug | 4-619-068-000-0 |

Dimensions: inches

| Size | A | B | C | D | F | G | H | J | K | Wt. lb. Less Oil | Max oz. |
|------|-------|------|-------|---------------|-------|------|------|------|------|---------------------|---------|
| 7.0 | 7.81 | 3.67 | 8.25 | .560 .999 | 1.000 | 1.62 | 1.62 | 2.34 | 2.24 | 12.65 | 27.6 |
| 9.4 | 10.25 | 4.70 | 10.89 | .770 1.249 | 1.250 | 2.06 | 2.12 | 3.10 | 3.09 | 27.70 | 65 |
| 12.4 | 13.50 | 5.98 | 13.67 | .820 1.624 | 1.625 | 2.12 | 2.75 | 3.88 | 3.88 | 51.07 | 150 |

| Single Flexing Coupling | |
|-------------------------|-------|
| 7.0 | AJ15* |
| 9.4 | AJ30* |
| 12.4 | AJ30* |

*Refers to TB Wood's Form-Flex couplings

Model HCM (Flexible Gear Couplings with Shrouded Bolts)

Size 7.0-12.4

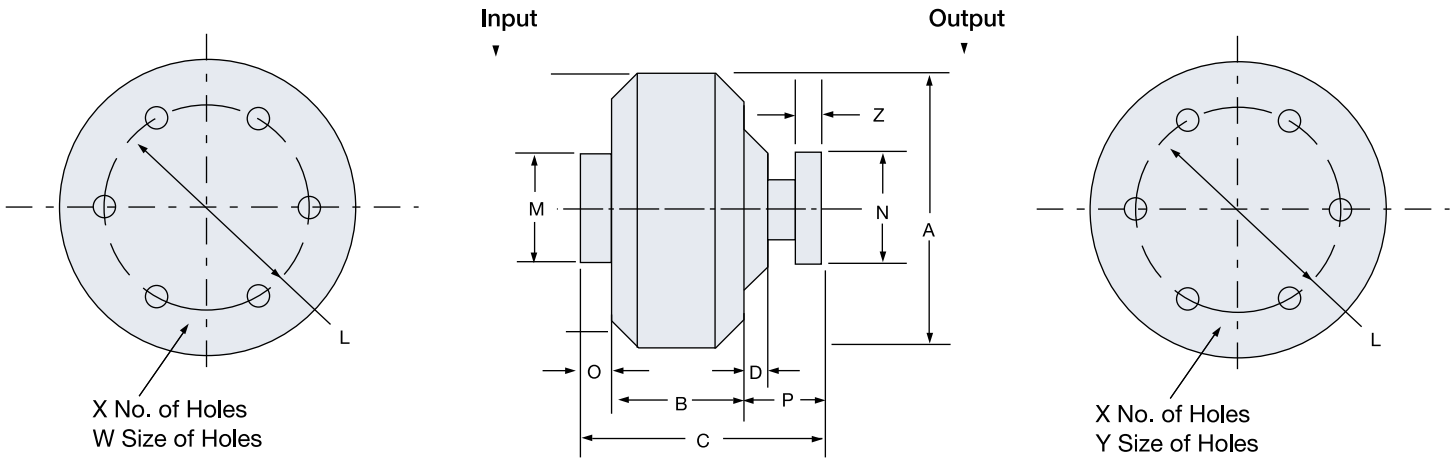

| Size | Assembly Number |
|-----------------------|--------------------|
| 7.0 | 6-607-003-000-0000 |
| 9.4 | 6-609-003-000-0000 |
| 12.4 | 6-612-003-000-0000 |
| 3/8" NPT Fusible Plug | 4-619-068-000-0 |

Dimensions: inches

| Size | A | B | C | D | L | M | N | O | P | W | X | Y | Z | Wt. lb. Less Oil | Oil Max oz. | WR ² lb. ft. ² | | Gear Coupling Size |
|------|-------|------|------|-----|-------|------|------|------|------|----------|---|------|------|------------------|-------------|--------------------------------------|-------|--------------------|
| | | | | | | | | | | | | | | | | Outer | Inner | |
| 7.0 | 7.81 | 3.67 | 5.98 | .56 | 3.75 | 4.70 | 4.56 | 1.10 | 1.21 | 1/4-20 | 6 | .254 | 3/16 | 16.10 | 27.6 | .42 | .10 | 1 |
| | | | | | | | | | | .56 Deep | | .256 | | | | | | |
| 9.4 | 10.25 | 4.70 | 7.49 | .77 | 4.812 | 5.90 | 6.00 | 1.14 | 1.65 | 3/8-16 | 8 | .380 | 1/4 | 32.25 | 65 | 1.27 | .51 | 1-1/2 |
| | | | | | | | | | | .65 Deep | | .382 | | | | | | |
| 12.4 | 13.50 | 5.98 | 8.67 | .82 | 4.812 | 6.85 | 6.00 | 1.14 | 1.55 | 3/8-16 | 8 | .380 | 1/4 | 53.25 | 150 | 4.12 | 1.33 | 1-1/2 |
| | | | | | | | | | | .74 Deep | | .382 | | | | | | |

HCM

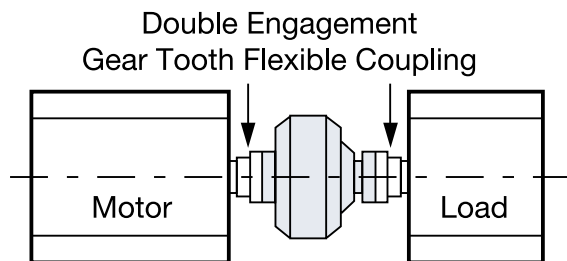

The Model HCM Fluid Coupling is a complete unit with both input and output flanges. It is intended for installation between two halves of a double engagement gear tooth flexible coupling which is customer supplied.

| Size | Manufacturer | Model | Maximum Bore | Diameter of Shrouded Bolt Circle |
|--------------|--------------|---------|--------------|----------------------------------|
| 7.0 | TB Woods | 1F | 1.75 | 3.75 |
| | Waldron | 1W | 1.63 | 3.750 |
| | Poole | MXB 1 | 1.63 | 3.750 |
| 9.4 and 12.4 | TB Woods | 1.5F | 2.25 | 4.812 |
| | Amerigear | 201.5 | 2.38 | 4.812 |
| | Waldron | 1.5W | 2.19 | 4.812 |
| | Poole | MXB 1.5 | 2.19 | 4.812 |

Note: Gear couplings must be with Shrouded Bolts!

Mesur-Fil® Fluid Couplings

Model HSD (Parallel Shaft Applications)

Sizes 7.0-12.4

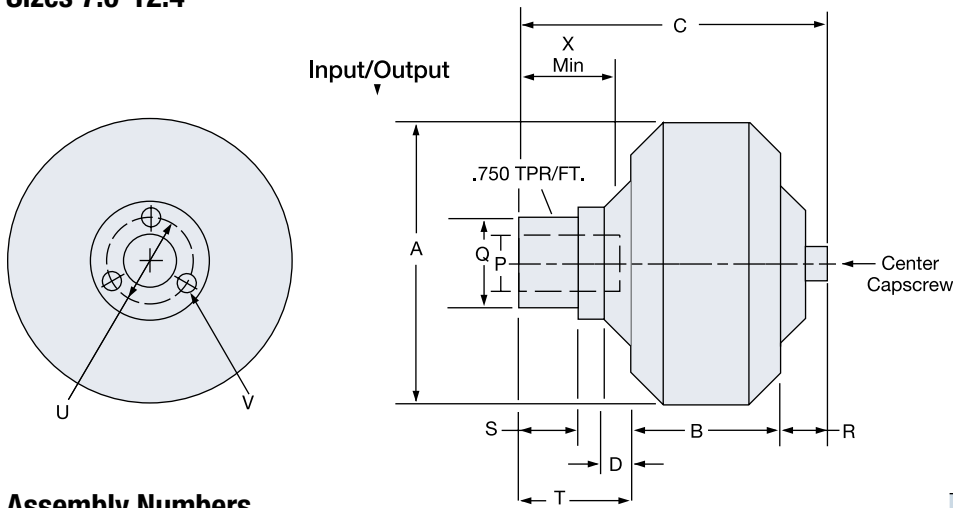

Assembly Numbers

| Size | Bore (in.) | Assembly Number |
|-----------------------|------------|--------------------|
| 7.0 | 7/8 | 6-607-005-001-0000 |
| | 1 | 6-607-005-002-0000 |
| | 1-1/8 | 6-607-005-003-0000 |
| | 1-3/8 | 6-607-005-004-0000 |
| | 1-1/8 | 6-609-005-001-0000 |
| 9.4 | 1-3/8 | 6-609-005-002-0000 |
| | 1-5/8 | 6-609-005-003-0000 |
| | 1-5/8 | 6-612-005-001-0000 |
| 12.4 | 1-7/8 | 6-612-005-002-0000 |
| | 2-1/8 | 6-612-005-003-0000 |
| | 2-3/8 | 6-612-005-004-0000 |
| 3/8" NPT Fusible Plug | | 4-619-068-000-0 |

P= Standard Input Sizes

| Size | Bore | Key |
|------|-------|------|
| 7.0 | 7/8 | 3/16 |
| | 1 | 1/4 |
| | 1 1/8 | 1/4 |
| | 1 3/8 | 5/16 |
| 9.4 | 1 1/8 | 1/4 |
| | 1 3/8 | 5/16 |
| | 1 5/8 | 3/8 |
| 12.4 | 1 5/8 | 3/8 |
| | 1 7/8 | 1/2 |
| | 2 1/8 | 1/2 |
| | 2 3/8 | 5/8 |

| Size | A | B | C | D | Q | R | S | T | U | V | X | Q.D. Hub Size | Dry Wt. |
|------|-------|------|-------|-----|-------|------|------|------|-------|---------|------|---------------|---------|
| 7.0 | 7.81 | 3.67 | 7.05 | .56 | 2.149 | .84 | 1.15 | 2.54 | 2.687 | 1/2-20 | 2.00 | SD | 12.75 |
| 9.4 | 10.25 | 4.70 | 9.35 | .77 | 2.736 | 1.12 | 1.45 | 3.53 | 3.313 | 5/16-18 | 2.50 | SK | 13.75 |
| 12.4 | 13.50 | 5.98 | 12.12 | .82 | 3.736 | 1.24 | 1.87 | 4.90 | 5.000 | 1/2-13 | 3.00 | E | 68.00 |

Do not use Eaton QD sheaves. Bolt pattern is not the same.

Vertical Mounting For HSD

When mounting the 7.0, 9.4 or 12.4 HSD on a vertical shaft, the motor and collet should be mounted above the sheave and fluid coupling. This position insures even the smallest oil fill will react with the motor.

Furthermore, order the unit with the standard and optional fill plugs on both sides of the unit. This allows for the addition and maintenance of the oil level within the fluid coupling.

| Model Size | Casting on Housing |
|------------|--------------------|
| 7.0 | 216262 A |
| | 216405 A |
| 9.4 | 216438 A |
| | 216439 A |
| 12.4 | 219463 A |
| | 219464 A |

| HSD | Maximum Speed |
|------|---------------|
| 7.0 | 3,600 RPM |
| 9.4 | 2,600 RPM |
| 12.4 | 1,800 RPM |

Important Note:

| Size | Center Capscrew Torque |
|--------------|------------------------|
| 7.0 | 38-42 lb.ft. |
| 9.4 and 12.4 | 177-195 lb.ft. |

How to Calculate Inertia (WR²) of a Spoked Wheel

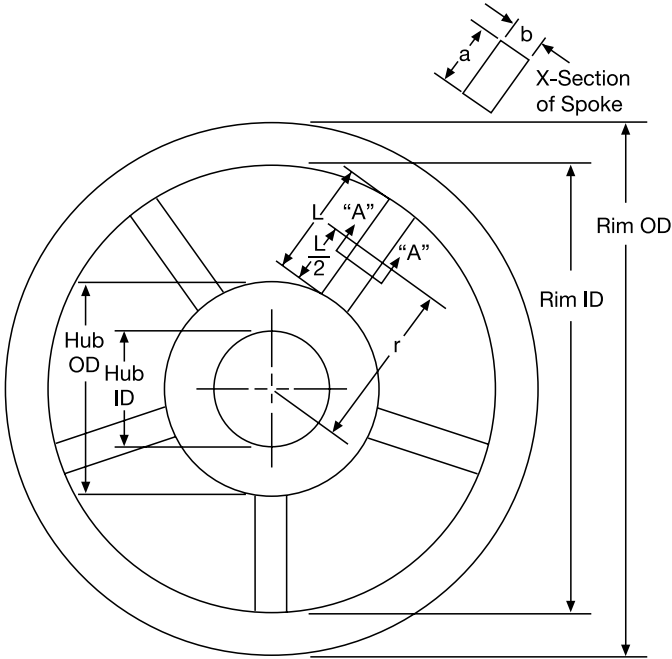

$$WR^2_s \text{ of Spokes} = \left[\left(\frac{b^2 + L^2}{1728} \right) + \left(\frac{r^2}{144} \right) \right] \times (\text{wt of Spokes}) \times (\text{No. of Spokes}), \text{ lb. ft.}^2$$

$$WR^2 \text{ of Rim} = \left[\frac{(\text{Rim OD})^2 + (\text{Rim ID})^2}{1152} \right] \times (\text{wt of Rim}), \text{ lb.ft.}^2$$

$$WR^2 \text{ of Hub} = \left[\frac{(\text{Hub OD})^2 + (\text{Hub ID})^2}{1152} \right] \times (\text{wt of Hub}), \text{ lb. ft.}^2$$

$$\text{Total Flywheel Inertia} = WR^2_s + WR^2_R + WR^2_H$$

Note: All dimensions are in inches.

Clutch heat horsepower absorption rate

Absorption rate/in² of lining area. For one stop at 70°F ambient temperature

| Slip time seconds | | 0 to 1 | 2 | 3 | 4 | 5 | 6 | 7 | 8 | 9 | 10 |
|-------------------|--------------------------------------|--------|-----|------|------|------|------|------|------|------|------|
| Heat Input | $\frac{\text{lb.ft.}}{\text{in.}^2}$ | 380 | 617 | 820 | 1000 | 1175 | 1330 | 1485 | 1630 | 1770 | 1900 |
| | $\frac{\text{HP}}{\text{in.}^2}$ | .7 | .56 | .5 | .45 | .43 | .4 | .38 | .37 | .36 | .34 |
| | $\frac{\text{btu}}{\text{in.}^2}$ | .49 | .79 | 1.05 | 1.29 | 1.51 | 1.71 | 1.91 | 2.09 | 2.27 | 2.4 |

Consult factory for slip time over 10 seconds.



Engineering Data

Engineering Formulas

Definitions

| | |
|-----------------|---|
| T | Torque-The moment of a system tends to cause rotation lb.in. % forces. |
| WR ² | Inertia-weight times radius of gyration ² lb.ft. ² |
| PSI | Pounds per square inch. |
| Wt. | Weight-lbs. |
| Btu | British Thermal Unit = 778 lb.ft. or one Btu. |
| CPM | Cycles per minute. |
| CF | Coefficient of friction. |
| C° | Degrees Celcius. |
| F° | Degrees Fahrenheit. |
| LN | Natural base log. |
| K and U | Inflation coefficients for specific clutch and brake. See specification tables. |
| R, E and V | Exhaust coefficient for specific clutch and brake. See specification tables. |
| KW | Keyway. |
| RPM | Revolutions per minute. |
| t | Seconds. |
| TIR | Total Indicator run out. |
| V | Volume-in ³ . |
| HP | Given amount of work in a specific time. 1 horsepower = 33,000 lb.ft. per minute. |

Formulas

| | |
|--|--|
| Torque lb. in. = | $\frac{(HP) (63,000)}{RPM}$ |
| Horsepower HP = | $\frac{(\text{Torque lb.in.}) (RPM)}{(63,000)}$ |
| Acceleration Torque (lb.in.) = | $\frac{(WR^2) (RPM)}{(25.6)(t)}$ |
| t= time in seconds for acceleration or deceleration. | |
| HP/100 RPM = | $\frac{(HP) (100)}{RPM} = \frac{\text{Required Torque lb.in.}}{(630)}$ |
| Required Unit PSI = | $\frac{(\text{Unit required Torque lb.in.}) (100 \text{ PSI})}{(\text{Unit rated torque lb.in.})}$ |
| Contact velocity FPM = | $\frac{(\text{Unit diameter in.}) (\pi)(RPM)}{(12)}$ |
| Unit heat HP = | $\frac{(\text{Total } WR^2) (RPM)^2 (CPM)}{1.9 \times 10^8}$ |

Genuine Replacement Parts

Longer Life

We have years of experience in building value into every Genuine Wichita Replacement Part. Our parts, made with quality materials and leading-edge technology, not only last longer than the competition, resulting in lower life cycle costs, they also fit precisely to give you the assurance of trouble-free performance. That's why we can confidently offer you the very best warranty in the business.

Faster Delivery

To help you lessen downtime problems, we've recently established new methods and procedures that will get Genuine Replacement Parts to you quicker than ever before. We've improved order processing, increased manufacturing capacities and added to our nationwide network of distributors. Many of our parts can now be shipped within 24 hours of your order or are available off-the-shelf from your local distributor. You don't have to pay a premium price for all the product and service advantages of Genuine Wichita Replacement Parts. You'll find our prices to be very competitive with any of the companies offering imitation replacement parts.

Warranty

When you specify Genuine Replacement Parts from Wichita you automatically expect more...and get more. Especially better performance, longer life and the peace of mind that comes with knowing you are working with the industry's proven leader. To further back up our quality commitment to you, we now offer a new three-year warranty on our line of replacement air tubes*, and a two-year warranty on all other components**. That's unmatched by anyone in our industry...and for good reason.

Air Tubes

- Wear resistance polymers insure compatibility with other Wichita parts
- Consistent size allows ease of replacement if required
- Low air volume construction reduces needless use of compressed air
- Combination of space-age fibers and elastomers give extended life and retention of size and fit



Friction Discs

- Special high strength materials with molded composite teeth resist functional wear and provide additional output torque
- Exactly match the mating Wichita component for consistent and maximum high torque output
- High heat resistance to combat unforeseen application problems
- Consistent size for ease of replacement
- Air grooves provide cooling and longer life

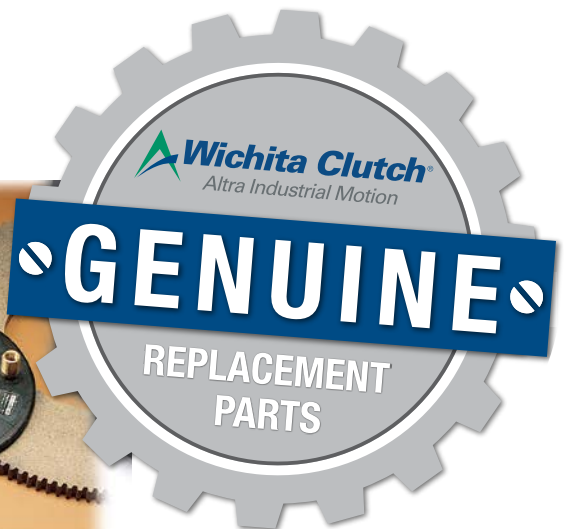

* Split air tubes are not intended for permanent installation and, therefore, are not covered under the warranty agreement.

** The warranty does not cover replacement or refurbishment of normal wear items.

**For after hours
emergency service,
call 1-940-631-4595.**

Altra Industrial Motion

Wichita Clutch Facilities

North America

USA
2800 Fisher Road
Wichita Falls, TX 76302 - USA
940-723-3400
Pneumatic Clutches
and Brakes

Europe

United Kingdom
Amphill Road
Bedford MK42 9RD - England
+44 (0) 1234 350311
Pneumatic Clutches
and Brakes

Asia Pacific

Australia
+61 2 9894 0133
China
+86 21 5169-9255
Hong Kong
+852 2615 9313
Singapore
+65 6487 4464
Taiwan
+886 2 2577 8156
Thailand
+66 2322 5527

The Brands of Altra Industrial Motion

Couplings

Ameridrives
www.ameridrives.com

Bibby Turboflex
www.bibbyturboflex.com

Guardian Couplings
www.guardiancouplings.com

Huco
www.huco.com

Lamiflex Couplings
www.lamiflexcouplings.com

Stromag
www.stromag.com

TB Woods
www.tbwoods.com

G geared Cam Limit Switches

Stromag
www.stromag.com

Electric Clutches & Brakes

Inertia Dynamics
www.idicb.com

Matrix
www.matrix-international.com

Stromag
www.stromag.com

Warner Electric
www.warnerelectric.com

Linear Products

Warner Linear
www.warnerlinear.com

Engineered Bearing Assemblies

Kilian
www.kilianbearings.com

Heavy Duty Clutches & Brakes

Industrial Clutch
www.indclutch.com

Twiflex
www.twiflex.com

Stromag
www.stromag.com

Svendborg Brakes
www.svendborg-brakes.com

Wichita Clutch
www.wichitaclutch.com

Belted Drives

TB Wood's
www.tbwoods.com

Gearing

Bauer Gear Motor
www.bauergears.com

Boston Gear
www.bostongear.com

Delroyd Worm Gear
www.delroyd.com

Nuttall Gear
www.nuttallgear.com

Overrunning Clutches

Formsprag Clutch
www.formsprag.com

Marland Clutch
www.marland.com

Stieber
www.stieberclutch.com

Neither the accuracy nor completeness of the information contained in this publication is guaranteed by the company and may be subject to change in its sole discretion. The operating and performance characteristics of these products may vary depending on the application, installation, operating conditions and environmental factors. The company's terms and conditions of sale can be viewed at <http://www.altramotion.com/terms-and-conditions/sales-terms-and-conditions>. These terms and conditions apply to any person who may buy, acquire or use a product referred to herein, including any person who buys from a licensed distributor of these branded products.

©2018 by Wichita Clutch LLC. All rights reserved. All trademarks in this publication are the sole and exclusive property of Wichita Clutch LLC or one of its affiliated companies.



BIBUS
SUPPORTING YOUR SUCCESS

BIBUS SK, s.r.o
Trnavská 31, SK-94 901 Nitra

Tel.: 037/ 7777 911 Email: sale@bibus.sk
Fax.: 037/ 7777 999 <http://www.bibus.sk>