



OUR INNOVATION MOVES



Rexnord Tollok Locking Assemblies Catalog

Metric



Download the most up-to-date version
at rexnord.com/documentation



Why Choose Rexnord Tollok Locking Assemblies?

Why Choose Rexnord?

When it comes to providing highly engineered products that improve productivity and efficiency for industrial applications worldwide, Rexnord is the most reliable in the industry. Our commitment to customer satisfaction and superior value extends to every area of our business.

Delivering Lowest Total Cost of Ownership

The highest quality products are designed to help prevent equipment downtime, increase productivity and deliver dependable operation.

Valuable Expertise

An extensive product offering is accompanied by global sales specialists, customer service and maintenance support teams, available anytime.

Solutions to Enhance Ease of Doing Business

Our commitment to operational excellence means you benefit from getting the right products to the right place at the right time.

Proven Reliability, Dependable Expertise, Broad Range of Options

For more than 35 years, Tollok® products have led the industry in locking assemblies. Our robust product offering features a wide range of options from simple and compact designs to advanced features. Our full line of locking assemblies can be customized to fit our customers ever-changing application needs and are ideal for use in heavy-duty and specially engineered environments.

Deliver Lower Total Cost of Ownership

Tollok designs its product by using state-of-the-art analysis tools to assure the most accurate designs possible. CAD drawings are directly integrated in a production system through CAD-CAM technology. This combined with the latest manufacturing methodology ensures high precision products with a short lead time.

Connecting Technology with Application Solutions

Tollok offers a broad range of internal locking assemblies, Internal locking assemblies, shrink discs and rigid couplings to fit to a wide range of applications. Tollok locking assemblies could be an alternative to a shaft/hub connection such as: key, splined, press fit, QD bushing or Taper Lock bushing. Tollok products are dimensionally interchangeable with most industry standard units.

Connecting Technology with the Best Service

Our product line is complemented with industry leading service. Each unit is protected, packed and suitably prepared for shipping. Tollok products are distributed worldwide. Regardless of the location, our customers can rely on our experienced application engineers for technical support.

Industries Served

Aggregates
Agriculture
Air Handling
Cement
Forest Products
Mining

Oil & Gas
Petrochemical
Primary Metals
Power Generation
Water Treatment

Locking assemblies

TLK 110

Page 8

Self-centering
Medium-high torque
Available from 6 mm to 130 mm diameter
Restricted radial encumbrance

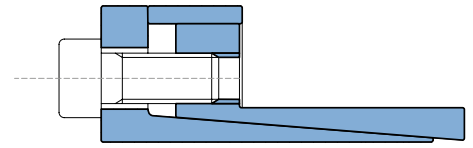

TLK 130

Page 10

Self-centering
High torque
Available from 18 mm to 240 mm diameter
Quick installation time

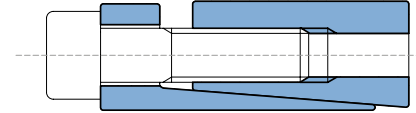

TLK 131

Page 10

Self-centering
Medium torque
Available from 18 mm to 240 mm diameter
Low surface pressures

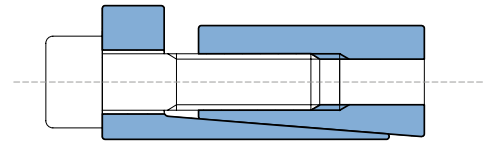

TLK 132

Page 12

Self-centering
Medium-high torque
TLK 132: Available from 18 mm to 200 mm diameter

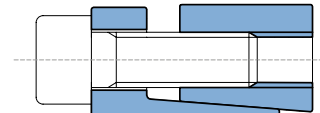

TLK 133/134

Page 12 / Page 15

Self-centering
Medium torque
TLK 133: Available from 18 mm to 200 mm diameter
TLK 134: Available from 14 mm to 50 mm diameter

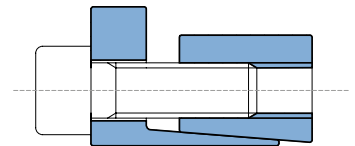

TLK 136

Page 16

Self-centering
High torque
High capacity to absorb bending moment
Available from 100 mm to 600 mm diameter

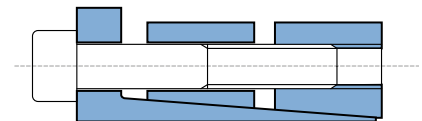

TLK 200

Page 18

Not self-centering
Medium torque
Available from 17 mm to 800 mm diameter
Self dismantling

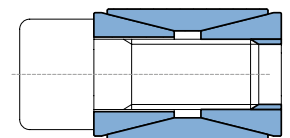

Locking assemblies

TLK 300

Page 20

Not self-centering
 Low torque
 Available from 6 mm to 540 mm diameter
 Restricted radial encumbrance

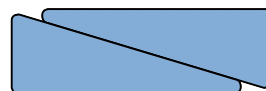

TLK 350

Page 22

Self-centering
 Medium-high torque
 Available from 6 mm to 50 mm diameter
 Restricted radial encumbrance

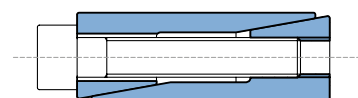

TLK 400/401

Page 24

Self-centering
 Very high torque
 TLK 400: Available from 45 mm to 400 mm diameter
 TLK 401: Available from 70 mm to 340 mm diameter
 Even pressures distribution

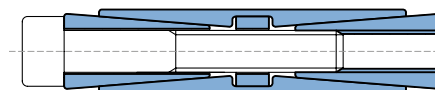

TLK 450/451

Page 26

Self-centering
 Very high torque
 TLK 450: Available from 25 mm to 400 mm diameter
 TLK 451: Available from 70 mm to 600 mm diameter
 Application economically advantageous

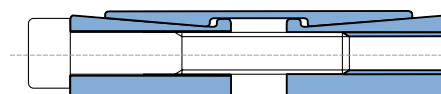

Shrink discs

TLK 500

Page 29

Rigid coupling
 Medium torque
 Available from 17 mm to 80 mm diameter
 Quick installation and dismantling

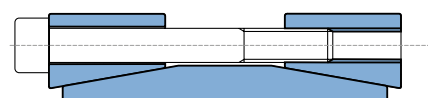

TLK 601/602/603

Page 31

Self-centering
 High / very high torque
 TLK 601/602: Available from 125 mm to 460 mm diameter
 TLK 603: Available from 14 mm to 480 mm diameter
 Quick installation time

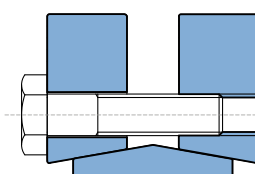

TLK 622/623/ 681/683

Page 37

Self-centering
 High / very high torque
 TLK 622/681: Available from 12 mm to 1200 mm diameter
 TLK 623/683: Available from 140 mm to 560 mm diameter
 Quick installation time

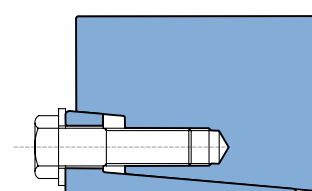

Application examples

Locking assemblies

EA01

Bearing axial fastening and gear locking by means of model TLK 350

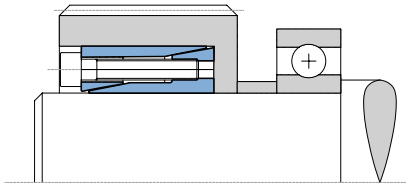
**EA02**

Chain sprocket locking by means of model TLK 130 with no split outside ring

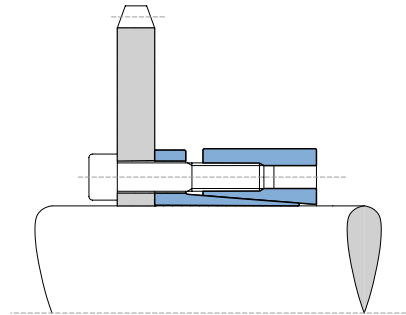
**EA03**

Thin plate locking by means of model TLK 133 with adapter ring

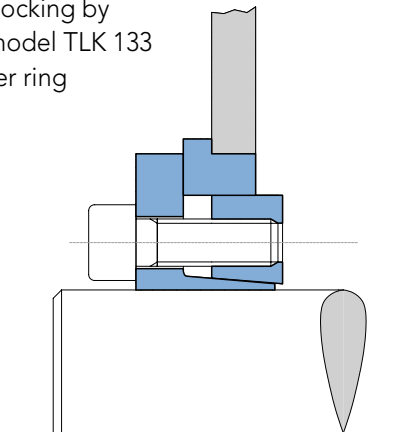
**EA04**

Break disc locking by means of special model TLK 700

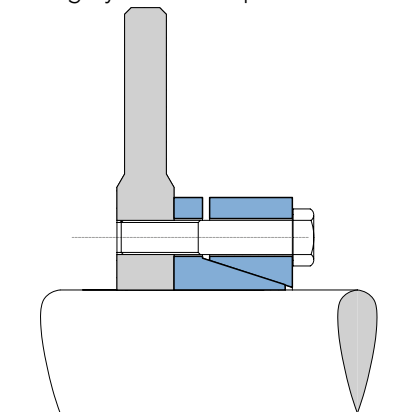
**EA05**

Hub locking by means of model TLK 200 with a special centering ring

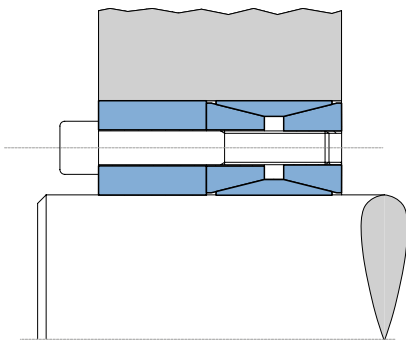
**EA06**

Large hub locking by means of special version of model TLK 400

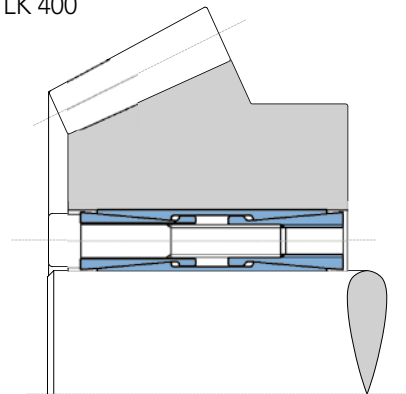

EA07

Cam locking by means of special model TLK 133

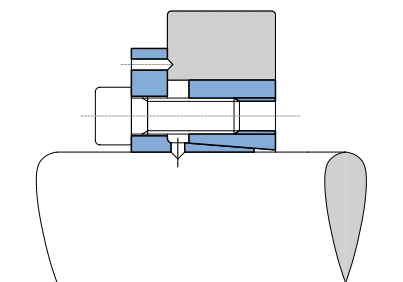

EA08

Use of model TLK 300 without spacer

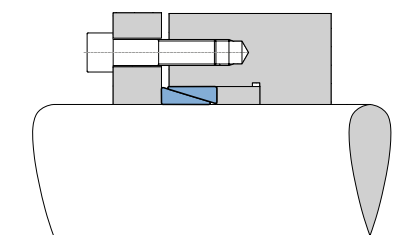

EA09

Use of several locking assemblies in presence of very heavy torque

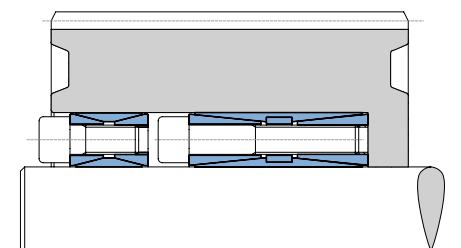

EA10

Use of model TLK 110 in presence of high rpm

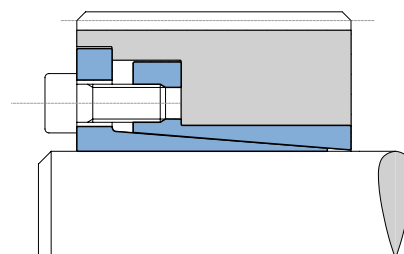

EA11

Special version of model TLK 132 with screws protection ring

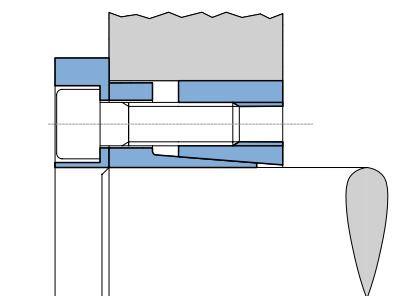

EA12

Special version of model TLK 132 with retaining ring

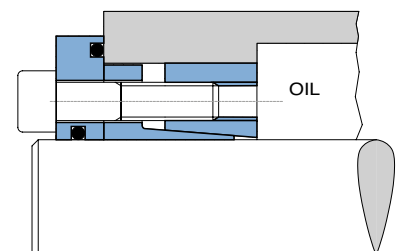

TLK 110

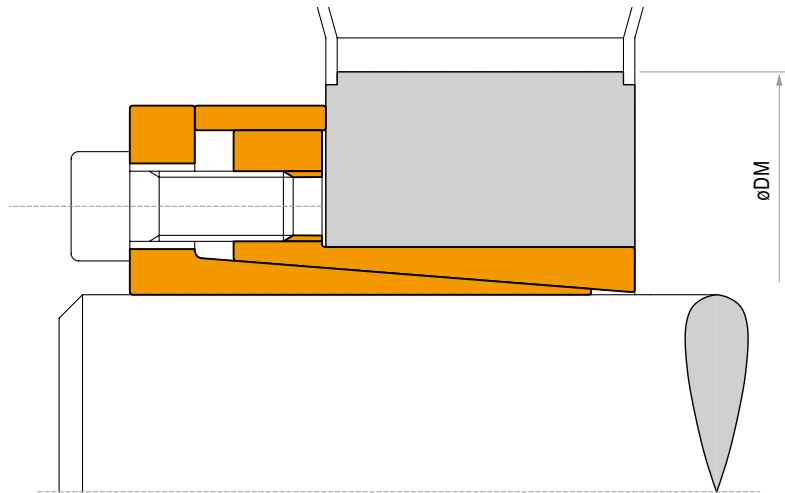

Characteristics

- Medium-high torque
- Restricted hub diameter
- Limited installation time
- Very low surface pressure

Installation

Carefully clean the hub and shaft contact surfaces and apply a light oil film. Slide the locking assembly into the hub bore, insert the shaft and tighten all screws gradually and regularly in crossed sequence to reach the tightening torque M_t , as indicated in the table.

The values M_t and F_{ax} indicated in the table are valid only in case of oil installation. Do not use any oil with **molibdenum bisulphide** or high pressure additives and not grease. Above substances notably reduce the friction coefficient.

Dismantling

Loosen the clamping screws. Insert the screws into the dismantling threading and tighten gradually and regularly in crossed sequence until the bottom cone is released. If the element is to be reused, relubricate both screws and threadings.

Tolerances, surface finish

A good surface finish by machine tool is sufficient.

Maximum allowable surface finish:
 R_t max 16 μm (R_a 3 μm - R_z 13 μm)

Maximum permissible tolerances:

h8 for shaft

H8 for hub

Axial movement

TLK 110: during screws tightening the hub has no axial movement with respect to the shaft.

DM hub calculation

The pressure P_n in the hub can be compared to the inside pressure on a thick hollow cylinder.

For DM calculation see page 42.

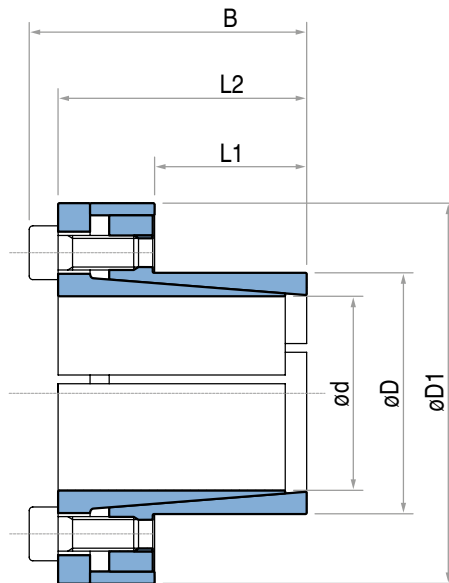

TLK 110 DIMENSIONS

Dimensions				Torque	Axial force	Surface pressures on		Tightening screws		Weight	
						Shaft	Hub	DIN912 12.9	Tightening torque		
d x D mm	L1 mm	L2 mm	B mm	D1 mm	M _t Nm	F _{ax} KN	P _w N/mm ²	P _n N/mm ²	N° x Type	M _s Nm	Kg
6 x 14	9	21	24	25	16	6	277	119	4 x M3	2	0,04
7 x 15	12	25	29	27	25	7	234	109	3 x M4	5	0,06
8 x 15	12	25	29	27	29	7	204	109	3 x M4	5	0,05
9 x 16	14	26	30	28	44	10	208	117	4 x M4	5	0,06
10 x 16	14	26	30	28	49	10	187	117	4 x M4	5	0,06
11 x 18	14	26	30	32	53	10	170	104	4 x M4	5	0,07
12 x 18	14	26	30	32	58	10	156	104	4 x M4	5	0,07
13 x 23	14	26	30	38	63	10	144	81	4 x M4	5	0,11
14 x 23	14	26	30	38	68	10	134	81	4 x M4	5	0,1
* 15 x 23	14	30	35	39	120	16	204	133	4 x M5	10	0,14
15 x 24	16	36	42	44	170	23	251	157	4 x M6	17	0,22
16 x 24	16	36	42	44	180	23	236	157	4 x M6	17	0,22
17 x 26	18	38	44	47	190	23	197	129	4 x M6	17	0,25
18 x 26	18	38	44	47	200	23	186	129	4 x M6	17	0,24
19 x 27	18	38	44	49	210	23	176	124	4 x M6	17	0,26
* 19 x 28	18	38	43	49	150	16	125	85	4 x M5	10	0,27
20 x 28	18	38	44	50	220	23	168	120	4 x M6	17	0,27
22 x 32	25	45	51	54	250	23	110	75	4 x M6	17	0,34
24 x 34	25	45	51	56	270	23	101	71	4 x M6	17	0,36
25 x 34	25	45	51	56	280	23	97	71	4 x M6	17	0,35
28 x 39	25	45	51	61	475	34	129	93	6 x M6	17	0,48
30 x 41	25	45	51	62	510	34	121	88	6 x M6	17	0,48
32 x 43	25	45	51	65	720	45	151	112	8 x M6	17	0,47
35 x 47	30	50	56	69	790	45	115	86	8 x M6	17	0,58
38 x 50	30	50	56	72	860	45	106	80	8 x M6	17	0,61
40 x 53	30	50	56	75	900	45	101	76	8 x M6	17	0,68
42 x 55	32	52	60	78	1750	84	166	127	8 x M8	41	0,76
45 x 59	40	65	73	85	1890	84	124	94	8 x M8	41	1,2
48 x 62	45	70	78	87	2010	84	103	80	8 x M8	41	1,2
50 x 65	45	70	78	92	2600	105	124	95	10 x M8	41	1,4
55 x 71	50	75	83	98	2850	105	101	79	10 x M8	41	1,6
60 x 77	50	75	83	104	3150	105	93	72	10 x M8	41	1,8
65 x 84	50	75	83	111	3400	105	86	66	10 x M8	41	2,1
70 x 90	60	91	101	119	5800	167	105	82	10 x M10	83	3
75 x 95	60	91	101	126	6200	167	98	78	10 x M10	83	3
80 x 100	65	96	106	131	8000	200	102	82	12 x M10	83	3,5
85 x 106	65	96	106	137	8500	200	96	77	12 x M10	83	3,6
90 x 112	65	96	106	144	11250	250	113	91	15 x M10	83	3,9
95 x 120	65	96	106	149	11850	250	107	85	15 x M10	83	4,4
100 x 125	65	96	106	154	15000	300	123	98	18 x M10	83	4,6
110 x 140	90	128	140	180	16000	291	78	61	12 x M12	145	8,7
120 x 155	90	128	140	198	17500	291	72	55	12 x M12	145	10,6
130 x 165	90	128	140	208	25000	389	88	69	16 x M12	145	11,3

* Upon request.
For larger diameter please contact us.

Locking assembly - Self-centering

TLK 130

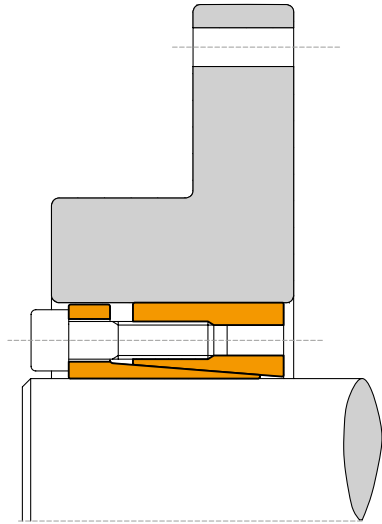

Characteristics

- High torque
- Application economically advantageous
- Limited installation time
- Excellent shaft-hub perpendicularity

Installation

Carefully clean the hub and shaft contact surfaces and apply a light oil film. Slide the locking assembly into the hub bore, insert the shaft and tighten gradually and regularly in crossed sequence all screws to reach the tightening torque M_t , as indicated in the table.

The values M_t and F_{ax} indicated in the table are valid only in case of oil installation. Do not use any oil with **molibdenum bisulphide** or high pressure additives and not grease. Above substances notably reduce the friction coefficient.

Dismantling

Loosen the clamping screws. Insert the screws into the dismantling threading and tighten gradually and regularly in crossed sequence until the back cone is released. If the element is to be reused, relubricate both screws and threads.

Locking assembly - Self-centering

TLK 131

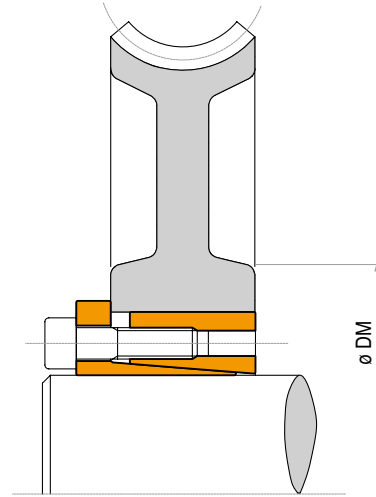

Tolerances, surface finish

A good surface finish by the machine tool is sufficient. Maximum allowable surface finish:
Rt max 16 μm (Ra 3 μm - Rz 13 μm)

Maximum permissible tolerances:

h8 for shaft

H8 for hub

Axial movement

TLK 130: during screws tightening the hub has a slight axial movement with respect to the shaft.

TLK 131: during screws tightening the hub has no axial movement with respect to the shaft.

DM hub calculation

The pressure P_n in the hub can be compared to the inside pressure on a thick hollow cylinder.

For DM calculation see page 42.

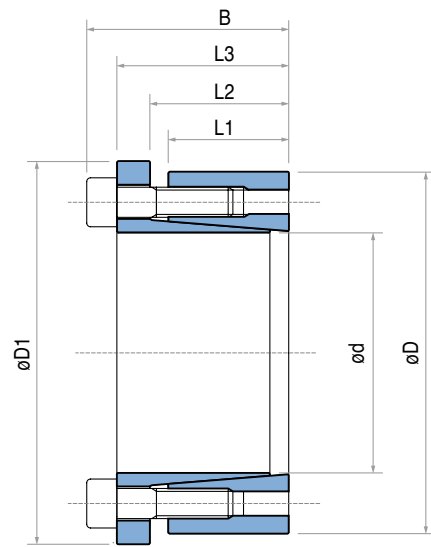
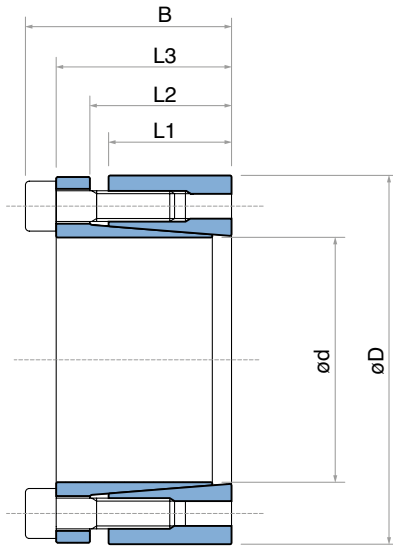

TLK 130 - TLK 131 DIMENSIONS

Dimensions						Only TLK 131	Tightening screws		TLK 130						TLK 131			
							DIN912 12.9	Tightening torque	Torque	Axial force	Surface pressures on		Weight	Torque	Axial force	Surface pressures on		Weight
											Shaft	Hub				Shaft	Hub	
d x D mm	L1 mm	L2 mm	L3 mm	B mm	D1 mm	N° x Type	M _s Nm	M _t Nm	F _{ax} KN	P _w N/mm ²	P _n N/mm ²	Kg	M _t Nm	F _{ax} KN	P _w N/mm ²	P _n N/mm ²	Kg	
18 x 47	26	30	41	47	53	6 x M6	17	490	55	310	119	0,4	300	34	193	74	0,5	
19 x 47	26	30	41	47	53	6 x M6	17	510	55	294	119	0,4	320	34	183	74	0,5	
20 x 47	26	30	41	47	53	6 x M6	17	540	55	279	119	0,4	340	34	174	74	0,5	
22 x 47	26	30	41	47	53	6 x M6	17	600	55	254	119	0,4	370	34	158	74	0,5	
24 x 50	26	30	41	47	56	6 x M6	17	650	55	233	112	0,4	400	34	145	70	0,5	
25 x 50	26	30	41	47	56	6 x M6	17	680	55	223	112	0,4	420	34	139	70	0,5	
28 x 55	26	30	41	47	61	6 x M6	17	760	55	199	102	0,5	470	34	124	63	0,6	
30 x 55	26	30	41	47	61	6 x M6	17	820	55	186	102	0,5	510	34	116	63	0,6	
32 x 60	26	30	41	47	66	8 x M6	17	1160	73	233	124	0,6	720	45	145	77	0,7	
35 x 60	26	30	41	47	66	8 x M6	17	1270	73	213	124	0,5	790	45	133	77	0,6	
38 x 65	26	30	41	47	71	8 x M6	17	1380	73	196	115	0,6	860	45	122	71	0,8	
40 x 65	26	30	41	47	71	8 x M6	17	1450	73	186	115	0,6	900	45	116	71	0,6	
42 x 75	30	35	49	57	81	6 x M8	41	2120	101	213	119	1	1320	63	133	74	1,2	
45 x 75	30	35	49	57	81	6 x M8	41	2270	101	199	119	1	1410	63	124	74	1,1	
48 x 80	30	35	49	57	86	8 x M8	41	3230	135	248	149	1,1	2010	84	155	93	1,3	
50 x 80	30	35	49	57	86	8 x M8	41	3370	135	238	149	1	2100	84	149	93	1,1	
55 x 85	30	35	49	57	91	8 x M8	41	3700	135	217	140	1,1	2310	84	135	87	1,2	
60 x 90	30	35	49	57	96	8 x M8	41	4040	135	199	132	1,2	2520	84	124	83	1,3	
65 x 95	30	35	49	57	101	8 x M8	41	4380	135	183	125	1,3	2730	84	114	78	1,4	
70 x 110	40	45	59	69	117	8 x M10	83	7490	214	203	129	2,2	4670	133	126	80	2,5	
75 x 115	40	45	59	69	122	8 x M10	83	8020	214	189	123	2,5	5000	133	118	77	2,6	
80 x 120	40	45	59	69	127	8 x M10	83	8560	214	177	118	2,6	5330	133	111	74	2,8	
85 x 125	40	45	59	69	132	10 x M10	83	11370	268	209	142	2,8	7080	167	130	88	2,8	
90 x 130	40	45	59	69	137	10 x M10	83	12040	268	197	136	2,7	7500	167	123	85	3	
95 x 135	40	45	59	69	142	10 x M10	83	12700	268	187	131	2,9	7920	167	116	82	3	
100 x 145	46	52	68	80	153	8 x M12	145	15580	312	180	124	3,9	9710	194	112	77	4,5	
110 x 155	46	52	68	80	163	8 x M12	145	17140	312	163	116	4,2	10680	194	102	72	4,8	
120 x 165	46	52	68	80	173	10 x M12	145	23370	390	187	136	4,8	14570	243	117	85	5,5	
130 x 180	46	52	68	80	188	12 x M12	145	30380	467	207	150	5	18940	291	129	93	6	
140 x 190	50	57	76	90	199	10 x M14	230	37410	535	203	149	6,5	23300	333	126	93	7,5	
150 x 200	50	57	76	90	209	12 x M14	230	48100	641	227	170	7	30000	400	141	106	7,7	
160 x 210	50	57	76	90	219	12 x M14	230	51300	641	213	162	7	32000	400	133	101	8	
170 x 225	50	57	76	90	234	14 x M14	230	63600	748	234	176	8,5	39650	467	146	110	9,8	
180 x 235	50	57	76	90	244	14 x M14	230	67350	748	221	169	9	42000	467	138	105	9,8	
190 x 250	50	57	76	90	259	15 x M14	230	76150	802	224	170	10,5	47500	500	140	106	11,4	
200 x 260	50	57	76	90	269	16 x M14	230	85500	855	227	175	10,5	53300	533	141	109	11,4	
210 x 270	50	57	76	90	279	16 x M14	230	89800	855	216	168	11	56000	533	135	105	11,8	
220 x 285	64	72	94	110	294	12 x M16	355	98050	891	168	130	16,5	61150	556	105	81	17,5	
240 x 305	64	72	94	110	314	15 x M16	355	133700	1114	192	151	18	83350	695	120	94	18,9	

For larger diameter or inch series please contact us.
 NOTE: it is possible to reduce the screws tightening torque down to 60% of the values indicated in above table;
 as a result M_t, F_{ax}, P_w, P_n are reduced proportionally.

Locking assembly - Self-centering

TLK 132

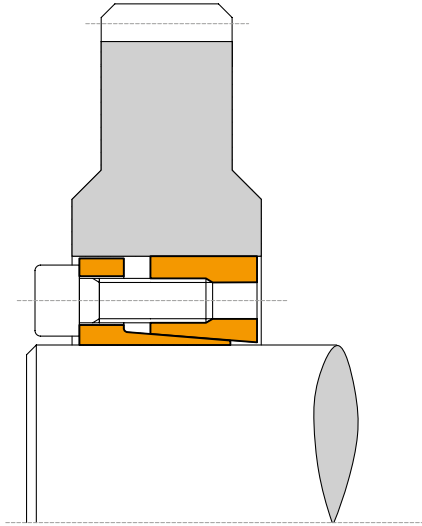

Characteristics

- Medium-high torque
- Application economically advantageous
- Limited installation time
- Interchangeable with TLK 200

Installation

Carefully clean the hub and shaft contact surfaces and apply a light oil film. Slide the locking assembly into the hub bore, insert the shaft and tighten gradually and regularly in crossed sequence all screws to reach the tightening torque M_s as indicated in the table.

The values M_t and F_{ax} indicated in the table are valid only in case of oil installation. Do not use any oil **with molybdenum bisulphide** or high pressure additives and not grease. Above substances notably reduce the friction coefficient.

Dismantling

Loosen the clamping screws. Insert the screws into the dismantling threading and tighten gradually and regularly in crossed sequence until the back cone is released. If the element is to be reused, relubricate both screws and threads.

Locking assembly - Self-centering

TLK 133

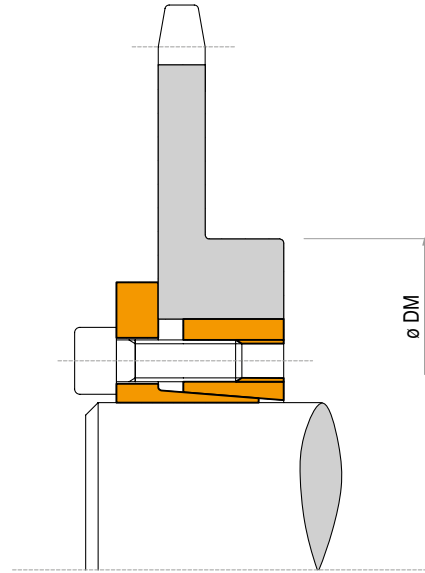

Tolerances, surface finish

A good surface finish by the machine tool is sufficient.

Maximum allowable surface finish:
 R_t max 16 μm (R_a 3 μm - R_z 13 μm)

Maximum permissible tolerances:

h8 for shaft

H8 for hub

Axial movement

TLK 132: during screws tightening the hub has a slight axial movement with respect to the shaft.

TLK 133: during screws tightening the hub has no axial movement with respect to the shaft.

DM hub calculation

The pressure P_n in the hub can be compared to the inside pressure on a thick hollow cylinder.

For DM calculation see page 42.

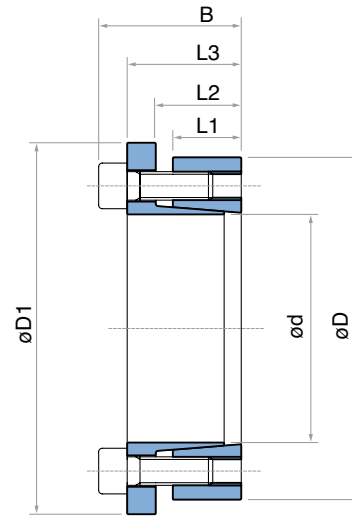
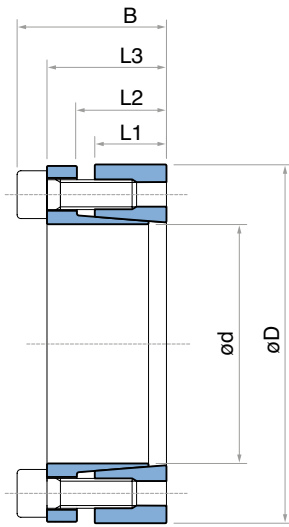

TLK 132 - TLK 133 DIMENSIONS

Dimensions					Only TLK 133	Tightening screws		TLK 132					TLK 133					
						DIN912 12.9	Tightening torque	Torque	Axial force	Surface pressures on		Weight	Torque	Axial force	Surface pressures on		Weight	
d x D mm	L1 mm	L2 mm	L3 mm	B mm	D1 mm	N° x Type	M _s (Nm) TLK 132	M _s (Nm) TLK 133	M _t Nm	F _{ax} KN	P _w N/mm ²				P _n N/mm ²	Kg		M _t Nm
18 x 47	17	22	28	34	53	5 x M6	14	17	330	38	326	125	0,35	250	28	246	94	0,3
19 x 47	17	22	28	34	53	5 x M6	14	17	350	38	308	125	0,3	270	28	233	94	0,3
20 x 47	17	22	28	34	53	6 x M6	14	17	450	45	352	150	0,3	340	34	266	113	0,3
22 x 47	17	22	28	34	53	6 x M6	14	17	490	45	320	150	0,3	370	34	242	113	0,3
24 x 50	17	22	28	34	56	6 x M6	14	17	540	45	293	141	0,3	400	34	222	106	0,3
25 x 50	17	22	28	34	56	6 x M6	14	17	560	45	281	141	0,3	420	34	213	106	0,3
28 x 55	17	22	28	34	61	6 x M6	14	17	630	45	251	128	0,4	470	34	190	97	0,4
30 x 55	17	22	28	34	61	6 x M6	14	17	670	45	234	128	0,3	510	34	177	97	0,4
32 x 60	17	22	28	34	67	8 x M6	14	17	960	60	293	156	0,4	720	45	222	118	0,4
35 x 60	17	22	28	34	67	8 x M6	14	17	1050	60	268	156	0,4	790	45	203	118	0,4
38 x 65	17	22	28	34	72	8 x M6	14	17	1140	60	247	144	0,4	860	45	187	109	0,5
40 x 65	17	22	28	34	72	8 x M6	14	17	1200	60	234	144	0,4	900	45	177	109	0,5
42 x 75	20	25	33	41	82	8 x M8	35	41	2410	115	363	204	0,8	1760	84	265	149	0,8
45 x 75	20	25	33	41	82	8 x M8	35	41	2580	115	339	204	0,6	1890	84	248	149	0,7
48 x 80	20	25	33	41	87	8 x M8	35	41	2760	115	318	191	0,8	2010	84	232	139	0,8
50 x 80	20	25	33	41	87	8 x M8	35	41	2870	115	305	191	0,8	2100	84	223	139	0,8
55 x 85	20	25	33	41	92	8 x M8	35	41	3160	115	278	180	0,8	2310	84	203	131	0,9
60 x 90	20	25	33	41	97	8 x M8	35	41	3450	115	254	170	0,8	2520	84	186	124	0,9
65 x 95	20	25	33	41	102	9 x M8	35	41	4200	129	264	181	0,9	3070	95	193	132	1
70 x 110	24	30	40	50	117	8 x M10	70	83	6300	181	285	181	1,8	4670	133	211	134	1,9
75 x 115	24	30	40	50	122	8 x M10	70	83	6750	181	266	173	1,8	5000	133	197	128	2
80 x 120	24	30	40	50	127	8 x M10	70	83	7200	181	249	166	1,8	5330	133	184	123	2
85 x 125	24	30	40	50	132	10 x M10	70	83	9600	226	293	200	2	7080	167	217	147	2
90 x 130	24	30	40	50	137	10 x M10	70	83	10150	226	277	192	2,1	7500	167	205	142	2,2
95 x 135	24	30	40	50	142	10 x M10	70	83	10700	226	263	185	2,1	7920	167	194	137	2,3
100 x 145	26	32	44	56	152	8 x M12	125	145	13450	269	274	189	2,8	9710	194	198	137	3
110 x 155	26	32	44	56	162	8 x M12	125	145	14750	269	249	177	3	10700	194	180	128	3,2
120 x 165	26	32	44	56	172	9 x M12	125	145	18150	302	257	187	3,2	13100	219	186	135	3,4
130 x 180	34	40	54	66	187	12 x M12	125	145	26200	403	242	175	4,8	18950	291	175	126	5,2
140 x 190	34	40	54	68	197	9 x M14	190	230	27800	397	221	163	5,2	21000	300	167	123	5,4
150 x 200	34	40	54	68	207	10 x M14	190	230	33100	442	230	172	5,4	25000	333	173	130	5,7
160 x 210	34	40	54	68	217	12 x M14	190	230	42400	530	258	197	5,7	32000	400	195	149	6
170 x 225	44	50	64	78	232	12 x M14	190	230	45050	530	188	142	8	34000	400	142	107	8,3
180 x 235	44	50	64	78	242	12 x M14	190	230	47700	530	177	136	8,3	36000	400	134	103	8,8
190 x 250	44	50	64	78	257	15 x M14	190	230	62900	662	210	160	9,6	47500	500	159	121	10
200 x 260	44	50	64	78	267	15 x M14	190	230	66250	662	200	154	10	50000	500	151	116	10,5

For larger diameter or inch series please contact us.

NOTE: it is possible to reduce the screws tightening torque down to 60% of the values indicated in above table; as a result M_t, F_{ax}, P_w, P_n are reduced proportionally.

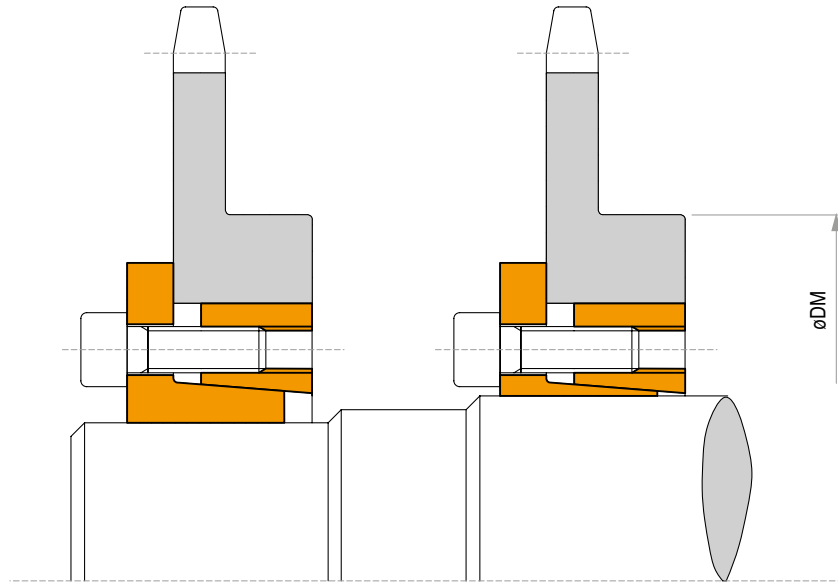

Characteristics

The same as TLK 133 (page12).

TLK 134 DIMENSIONS

Dimensions						Torque	Axial force	Surface pressures on		Tightening screws		Weight
d x D mm	L1 mm	L2 mm	L3 mm	B mm	D1 mm			Shaft	Hub	DIN912 12.9	Tightening torque	
						F_{ax} KN	P_w N/mm ²	P_n N/mm ²	N° x Type	M_s Nm	Kg	
14 x 55	17	22	30	38	62	290	42	468	119	4 x M8	41	0,5
16 x 55	17	22	30	38	62	340	42	410	119	4 x M8	41	0,5
18 x 55	17	22	30	38	62	380	42	364	119	4 x M8	41	0,5
19 x 55	17	22	30	38	62	400	42	345	119	4 x M8	41	0,5
20 x 55	17	22	30	38	62	420	42	328	119	4 x M8	41	0,5
22 x 55	17	22	30	38	62	460	42	298	119	4 x M8	41	0,5
24 x 55	17	22	30	38	62	500	42	273	119	4 x M8	41	0,5
25 x 55	17	22	30	38	62	530	42	262	119	4 x M8	41	0,5
28 x 55	17	22	30	38	62	590	42	234	119	4 x M8	41	0,4
30 x 55	17	22	30	38	62	630	42	219	119	4 x M8	41	0,4
24 x 65	17	22	30	38	72	630	53	342	126	5 x M8	41	0,7
25 x 65	17	22	30	38	72	660	53	328	126	5 x M8	41	0,7
28 x 65	17	22	30	38	72	740	53	293	126	5 x M8	41	0,6
30 x 65	17	22	30	38	72	790	53	273	126	5 x M8	41	0,6
32 x 65	17	22	30	38	72	840	53	256	126	5 x M8	41	0,6
35 x 65	17	22	30	38	72	920	53	234	126	5 x M8	41	0,5
38 x 65	17	22	30	38	72	1000	53	216	126	5 x M8	41	0,5
40 x 65	17	22	30	38	72	1050	53	205	126	5 x M8	41	0,5
30 x 80	20	25	33	41	87	1100	74	325	122	7 x M8	41	1,0
32 x 80	20	25	33	41	87	1180	74	305	122	7 x M8	41	1,0
35 x 80	20	25	33	41	87	1290	74	279	122	7 x M8	41	1,0
38 x 80	20	25	33	41	87	1400	74	257	122	7 x M8	41	1,0
40 x 80	20	25	33	41	87	1470	74	244	122	7 x M8	41	0,9
42 x 80	20	25	33	41	87	1540	74	232	122	7 x M8	41	0,9
45 x 80	20	25	33	41	87	1650	74	217	122	7 x M8	41	0,8
48 x 80	20	25	33	41	87	1760	74	203	122	7 x M8	41	0,8
50 x 80	20	25	33	41	87	1840	74	195	122	7 x M8	41	0,8

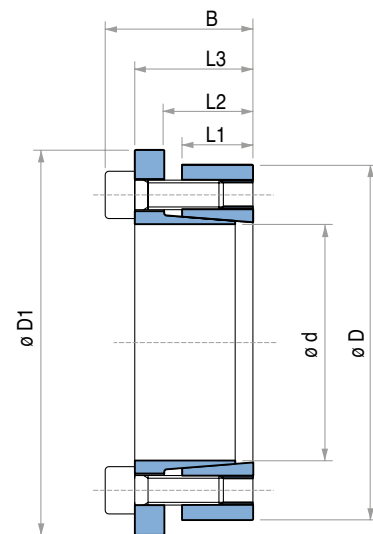

TLK 136

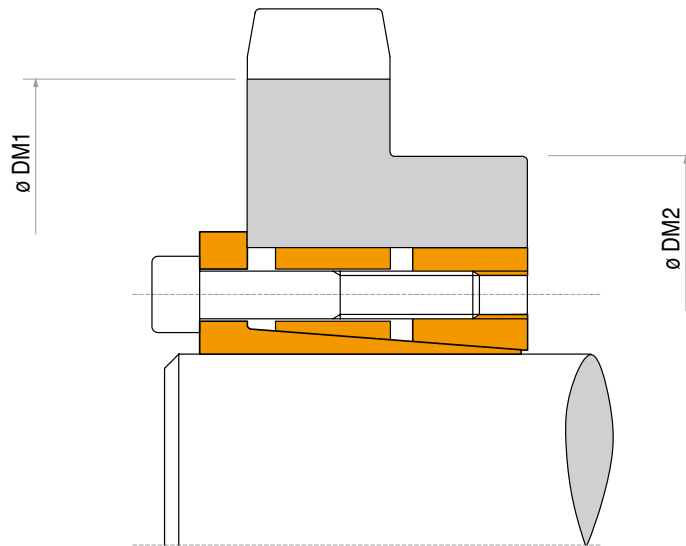

Characteristics

- High torque, high bending moments
- Excellent shaft-hub perpendicularity
- Low surface pressures
- Quick installation time

Installation

Carefully clean the hub and shaft contact surfaces and apply a thin film of light-weight oil. Slide the locking assembly onto shaft, insert them into the hub bore and tighten gradually and regularly in crossed sequence all screws (first the smaller screws, then the bigger ones) to reach the tightening torque M_s as indicated in the table. The values M_t and F_{ax} indicated in the table are valid only in case of oil installation. Do not use any oil with molybdenum bisulphide or high pressure additives and not grease. Above substances notably reduce the friction coefficient.

Dismantling

Loosen the small screws for some turn only and loosen completely the big screws. Insert the big screws into the dismantling threading and tighten gradually and regularly in crossed sequence until the cones are released.

Tolerances, surface finish

A good surface finish by machine tool is sufficient.

Maximum allowable surface finish:
 R_t max 16 μm (R_a 3 μm - R_z 13 μm)

Maximum permissible tolerances:

h8 for shaft

H8 for hub

Axial movement

TLK 136: during screws tightening the hub has no axial movement with respect to the shaft.

DM hub calculation

The pressure P_n in the hub can be compared to the inside pressure on a thick hollow cylinder.

For DM calculation see page 42.

TLK 136

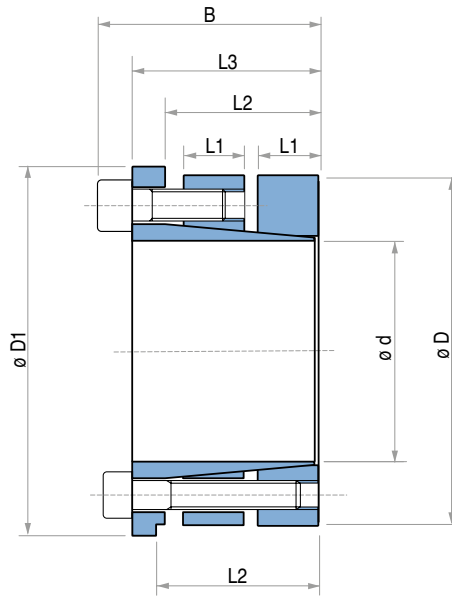

* For diameters > 420 mm.

TLK 136 DIMENSIONS

Dimensions					Torque				Axial force			Surface pressures on				Tightening screws 1		Tightening screws 2		Weight
												Shaft		Hub		DIN912 12.9	Tightening torque	DIN912 12.9	Tightening torque	
d x D mm	L1 mm	L2 mm	L3 mm	B mm	D1 mm	M _t 1 Nm	M _t 2 Nm	M _t tot Nm	F _{ax} 1 KN	F _{ax} 2 KN	F _{ax} tot KN	p _w 1 N/mm ²	p _w 2 N/mm ²	p _n 1 N/mm ²	p _n 2 N/mm ²	N° x Type	M _t Nm	N° x Type	M _t Nm	Kg
100 x 150	26	61	82	96	159	11600	8500	20100	233	170	403	238	174	159	116	7 x M14	230	7 x M12	145	6,3
110 x 160	26	61	82	96	169	12800	9300	22100	233	170	403	217	158	149	109	7 x M14	230	7 x M12	145	6,8
120 x 170	26	61	82	96	179	13900	10200	24100	233	170	403	199	145	140	103	7 x M14	230	7 x M12	145	7,3
130 x 190	30	71	95	111	199	24000	17200	41200	370	266	636	253	182	173	125	8 x M16	355	8 x M14	230	11,1
140 x 200	30	71	95	111	209	25900	18600	44500	370	266	636	235	169	164	118	8 x M16	355	8 x M14	230	11,8
150 x 210	30	71	95	111	219	27700	19900	47600	370	266	636	219	158	157	113	8 x M16	355	8 x M14	230	12,5
160 x 220	30	71	95	111	229	29600	21200	50800	370	266	636	205	148	149	108	8 x M16	355	8 x M14	230	13,1
170 x 240	40	92	122	142	249	49100	31400	80500	578	370	948	226	145	160	103	8 x M20	690	8 x M16	355	21,3
180 x 250	40	92	122	142	259	52000	33300	85300	578	370	948	214	137	154	99	8 x M20	690	8 x M16	355	22,3
190 x 260	40	92	122	142	269	54900	35100	90000	578	370	948	202	130	148	95	8 x M20	690	8 x M16	355	23,3
200 x 270	40	92	122	142	279	72200	46300	118500	722	463	1185	240	154	178	114	10 x M20	690	10 x M16	355	24,6
220 x 290	40	92	122	142	299	79400	50900	130300	722	463	1185	218	140	166	106	10 x M20	690	10 x M16	355	26,5
240 x 310	40	92	122	142	319	104000	66600	170600	867	555	1422	240	154	186	119	12 x M20	690	12 x M16	355	28,7
260 x 330	40	92	122	142	339	112700	72100	184800	867	555	1422	222	142	175	112	12 x M20	690	12 x M16	355	30,8
280 x 365	45	108	144	168	374	145400	101000	246400	1039	722	1761	219	153	168	117	10 x M24	1200	10 x M20	690	46,5
300 x 385	45	108	144	168	394	155800	108300	264100	1039	722	1761	205	143	160	111	10 x M24	1200	10 x M20	690	49,5
320 x 405	45	108	144	168	414	199500	138700	338200	1247	867	2114	230	160	182	127	12 x M24	1200	12 x M20	690	52,7
340 x 425	45	108	144	168	434	247100	172000	419100	1454	1012	2466	253	176	202	141	14 x M24	1200	14 x M20	690	55,1
360 x 445	45	108	144	168	454	261700	182100	443800	1454	1012	2466	239	166	193	135	14 x M24	1200	14 x M20	690	58,6
380 x 465	45	108	144	168	474	315700	219600	535300	1662	1156	2818	258	180	211	147	16 x M24	1200	16 x M20	690	61,7
400 x 485	45	108	144	168	494	332400	231200	563600	1662	1156	2818	246	171	203	141	16 x M24	1200	16 x M20	690	64,4
420 x 505	45	108	144	168	514	349000	242700	591700	1662	1156	2818	234	163	195	136	16 x M24	1200	16 x M20	690	67,5
440 x 525	59	147	178	202	534	365600	254300	619900	1662	1156	2818	170	143	119	100	16 x M24	1200	16 x M20	690	86,0
460 x 545	59	147	178	202	554	382200	265800	648000	1662	1156	2818	163	138	114	96	16 x M24	1200	16 x M20	690	89,4
480 x 565	59	147	178	202	574	398800	277400	676200	1662	1156	2818	156	133	109	93	16 x M24	1200	16 x M20	690	92,9
500 x 585	59	147	178	202	594	467500	325200	792700	1870	1301	3171	169	144	118	101	18 x M24	1200	18 x M20	690	96,5
520 x 605	59	147	178	202	614	486200	338200	824400	1870	1301	3171	162	140	113	97	18 x M24	1200	18 x M20	690	100
540 x 625	59	147	178	202	634	504900	351200	856100	1870	1301	3171	156	135	109	94	18 x M24	1200	18 x M20	690	104
560 x 645	59	147	178	202	654	523600	364200	887800	1870	1301	3171	151	131	105	91	18 x M24	1200	18 x M20	690	107
580 x 665	59	147	178	202	674	602600	419000	1021600	2078	1445	3523	162	141	113	98	20 x M24	1200	20 x M20	690	111
600 x 685	59	147	178	202	694	623400	433500	1056900	2078	1445	3523	156	137	109	95	20 x M24	1200	20 x M20	690	114

For other dimensions, please contact us.

Locking assembly - Not self-centering

TLK 200

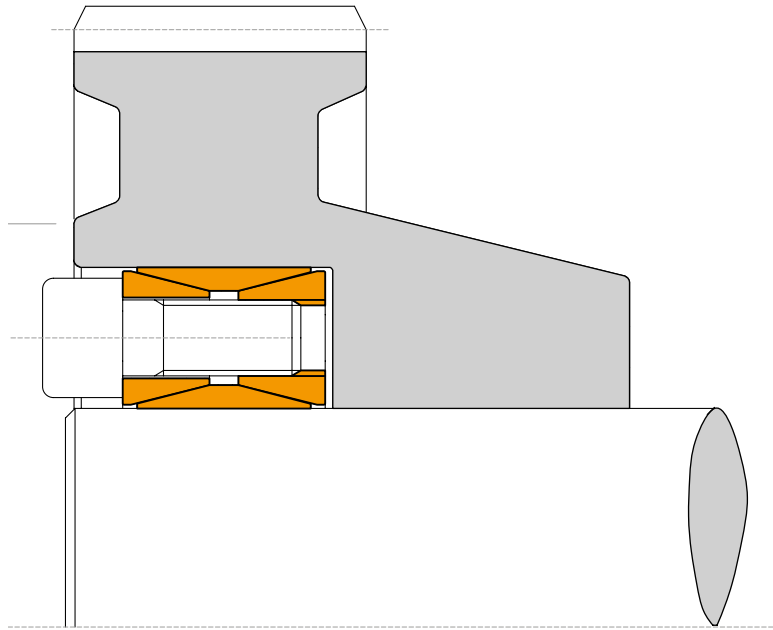

Characteristics

- Medium-high torque
- Wide tolerances
- Easy availability
- Easy dismantling

Installation

Carefully clean the hub and shaft contact surfaces and apply a light oil film. Slide the locking assembly into the hub bore and insert the shaft. Tighten cadmium plated clamping screws until inner ring grips the shaft and the outer ring grips the hub bore then tighten gradually and regularly in crossed sequence all screws to reach the tightening torque M_s indicated in the table. The values M_t and F_{ax} indicated in the table are valid only in case of oil installation. Do not use any oil with **molibdenum bisulphide** or high pressure additives and not grease.

Dismantling

By loosening all tightening screws the clamping unit is normally released. In case of difficulties slightly hammer the released screws to push back the rear pressure cone.

Tolerances, surface finish

A good surface finish by machine tool is sufficient. Maximum allowable surface finish:
Rt max 16 μm (Ra 3 μm - Rz 13 μm)

Maximum permissible tolerances:

h11 for shaft

H11 for hub

Centering

Mod. TLK 200 is not self-centering. The hub concentricity with respect to the shaft depends on the guide surface tolerance and its length.

Axial movement

TLK 200: during screws tightening the hub has no axial movement with respect to the shaft.

DM hub calculation

The pressure P_n in the hub can be compared to the inside pressure on a thick hollow cylinder.

For DM calculation see page 42.

M_t transmissible

If two or more clamping unit are installed together, as a result of carried tests, the M_t transmissible shall be calculated as follow:

Nr. 1 TLK 200 $M_t = M_t \text{ cat.}$

Nr. 2 TLK 200 $M_t = M_t \text{ cat.} \bullet 1,9$

Nr. 3 TLK 200 $M_t = M_t \text{ cat.} \bullet 2,7$

TLK 200 DIMENSIONS

Dimensions				Shaft / Hub tolerances h11 / H11				Shaft / Hub tolerances h7 / H7		Tightening screws		Weight
				Torque M_t Nm	Axial force F_{ax} KN	Surface pressures on		Torque M_t Nm	Pressure on Hub p_n N/mm ²	DIN912 12.9 N° x Type	Tightening torque M_t Nm	
Shaft p_w N/mm ²	Hub p_n N/mm ²											
d x D mm	L1 mm	L2 mm	B mm									
17 x 47	17	20	26	280	33	305	110	310	125	8 x M6	17	0,2
18 x 47	17	20	26	300	33	290	110	330	125	8 x M6	17	0,2
19 x 47	17	20	26	310	33	275	110	350	125	8 x M6	17	0,2
20 x 47	17	20	26	330	33	260	110	370	125	8 x M6	17	0,2
22 x 47	17	20	26	360	33	235	110	410	125	8 x M6	17	0,2
24 x 50	17	20	26	390	33	215	105	440	115	8 x M6	17	0,3
25 x 50	17	20	26	410	33	205	105	460	115	8 x M6	17	0,3
28 x 55	17	20	26	570	41	230	115	650	130	10 x M6	17	0,3
30 x 55	17	20	26	610	41	215	115	690	130	10 x M6	17	0,3
32 x 60	17	20	26	780	49	240	130	890	145	12 x M6	17	0,3
35 x 60	17	20	26	850	49	220	125	970	145	12 x M6	17	0,3
38 x 65	17	20	26	1070	57	235	135	1230	155	14 x M6	17	0,4
40 x 65	17	20	26	1120	56	220	135	1300	155	14 x M6	17	0,3
42 x 75	20	24	32	1860	89	280	155	2170	185	12 x M8	41	0,6
45 x 75	20	24	32	1990	89	260	155	2320	185	12 x M8	41	0,6
48 x 80	20	24	32	2120	88	245	145	2480	170	12 x M8	41	0,6
50 x 80	20	24	32	2200	88	235	145	2580	170	12 x M8	41	0,6
55 x 85	20	24	32	2810	102	245	160	3310	190	14 x M8	41	0,6
60 x 90	20	24	32	3050	102	225	150	3610	180	14 x M8	41	0,7
65 x 95	20	24	32	3770	116	235	160	4470	190	16 x M8	41	0,7
70 x 110	24	28	38	5600	160	255	160	6700	190	14 x M10	83	1,3
75 x 115	24	28	38	5970	159	235	155	7170	185	14 x M10	83	1,3
80 x 120	24	28	38	6330	158	220	145	7650	175	14 x M10	83	1,4
85 x 125	24	28	38	7660	180	235	160	9290	195	16 x M10	83	1,4
90 x 130	24	28	38	8080	180	220	155	9840	185	16 x M10	83	1,5
95 x 135	24	28	38	9560	201	235	165	11600	200	18 x M10	83	1,6
100 x 145	26	33	45	11300	227	230	160	13900	195	14 x M12	145	2,2
110 x 155	26	33	45	12400	226	210	150	15300	185	14 x M12	145	2,5
120 x 165	26	33	45	15400	258	220	160	19100	195	16 x M12	145	2,6
130 x 180	34	38	50	20800	320	190	140	25800	175	20 x M12	145	3,8
140 x 190	34	38	50	24500	351	195	145	30600	180	22 x M12	145	3,9
150 x 200	34	38	50	28500	381	200	150	35800	185	24 x M12	145	4
160 x 210	34	38	50	32900	411	200	155	41400	190	26 x M12	145	4,3
170 x 225	38	44	58	40400	476	195	150	51000	185	22 x M14	230	5,8
180 x 235	38	44	58	46500	518	200	155	59000	195	24 x M14	230	6
190 x 250	46	52	66	57200	602	185	140	72600	175	28 x M14	230	8,5
200 x 260	46	52	66	64200	643	185	145	81900	180	30 x M14	230	8,6
220 x 285	50	56	72	84500	769	185	145	108500	185	26 x M16	355	11
240 x 305	50	56	72	106000	884	195	155	136600	200	30 x M16	355	12
260 x 325	50	56	72	129300	995	205	160	167800	210	34 x M16	355	13
280 x 355	60	66	84	157200	1123	175	140	204600	180	32 x M18	485	19
300 x 375	60	66	84	188200	1255	185	150	246700	195	36 x M18	485	20
320 x 405	72	78	98	259400	1622	185	150	341400	195	36 x M20	690	30
340 x 425	72	78	98	274500	1615	175	140	362700	185	36 x M20	690	30
360 x 455	84	90	112	360300	2002	175	140	478100	185	36 x M22	930	42
380 x 475	84	90	112	378700	1994	165	135	504600	175	36 x M22	930	44
400 x 495	84	90	112	397000	1985	155	125	531200	170	36 x M22	930	46
420 x 515	84	90	112	461800	2199	165	135	619700	180	40 x M22	930	50
440 x 545	96	102	126	557200	2533	160	130	749700	175	40 x M24	1200	65
460 x 565	96	102	126	580800	2526	150	125	783800	165	40 x M24	1200	67
480 x 585	96	102	126	634600	2644	150	125	858800	170	42 x M24	1200	71
500 x 605	96	102	126	690500	2762	155	125	937200	170	44 x M24	1200	73
520 x 630	96	102	126	732400	2817	150	125	996800	170	45 x M24	1200	80
540 x 650	96	102	126	759500	2813	145	120	1035000	165	45 x M24	1200	82
560 x 670	96	102	126	837700	2992	150	125	1145000	170	48 x M24	1200	85
580 x 690	96	102	126	902500	3112	150	125	1235000	170	50 x M24	1200	88
600 x 710	96	102	126	930900	3103	145	120	1278000	165	50 x M24	1200	91
620 x 730	96	102	126	997500	3218	145	120	1373000	170	52 x M24	1200	93
640 x 750	96	102	126	1067000	3337	145	125	1472000	170	54 x M24	1200	96
660 x 770	96	102	126	1140000	3456	145	125	1574000	170	56 x M24	1200	99
680 x 790	96	102	126	1173000	3450	140	120	1622000	165	56 x M24	1200	102
700 x 810	96	102	126	1290000	3686	145	125	1789000	175	60 x M24	1200	104
720 x 830	96	102	126	1325000	3681	140	125	1840000	170	60 x M24	1200	107
740 x 850	96	102	126	1405000	3798	140	125	1954000	170	62 x M24	1200	110
760 x 870	96	102	126	1487000	3915	140	125	2072000	175	64 x M24	1200	113
780 x 890	96	102	126	1548000	3970	140	125	2159000	170	65 x M24	1200	116
800 x 910	96	102	126	1610000	4025	140	120	2249000	170	66 x M24	1200	118

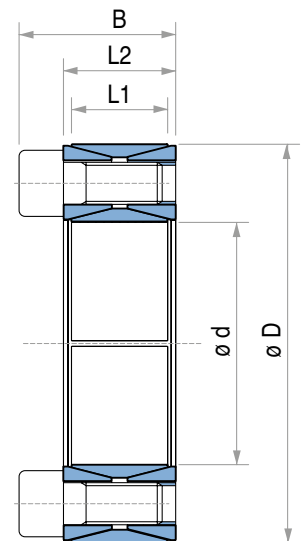

For larger diameter please contact us.

Locking assembly - Not self-centering

TLK 300

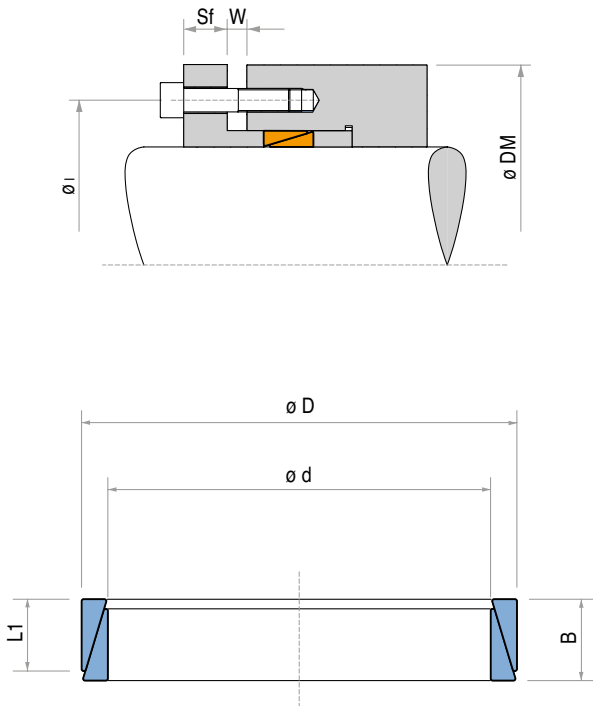

TLK 300 DIMENSIONS

dg	DIN912			C=0,140		
	Pv in N			Mt in Nm		
	8.8	10.9	12.9	8.8	10.9	12.9
M4	3900	5450	6550	2,9	4,1	4,9
M5	6350	8950	10700	6	8,5	10
M6	9000	12600	15100	10	14	17
[M7]	13200	18500	22200	16	23	28
M8	16500	23200	27900	25	35	41
[M9]	22000	30900	37100	36	51	61
M10	26200	36900	44300	49	69	83
M12	38300	54000	64500	86	120	145
M14	52500	74000	88500	135	190	230
M16	73000	102000	123000	210	295	355
M18	88000	124000	148000	290	405	485
M20	114000	160000	192000	410	580	690
M22	141000	199000	239000	550	780	930
M24	164000	230000	276000	710	1000	1200
M27	215000	302000	363000	1050	1500	1800
M30	262000	368000	442000	1450	2000	2400

$$Pa = N^{\circ} \text{ of screws} \cdot Pv$$

$$Pt = \text{see page 21}$$

$$M_t \text{ transmissible} = \frac{Pa - Pt}{0,54} \cdot 0,12 \cdot \frac{d}{2000}$$

Screws center distance $l = D + 12 + dg$ (screws fixed on the hub) Flange thickness $Sf = dg \cdot 1,3$ (screws quality 8.8)
 Screws center distance $l = d - 12 - dg$ (screws fixed on the shaft) Flange thickness $Sf = dg \cdot 1,8$ (screws quality 12.9)

Note: On request the type TLK 300 can be supplied also with split rings: therefore the transmissible torque M_t increases. Please contact our technical department.

Characteristics

- Medium low torque
- Restricted radial encumbrance
- Limited installation time
- Application economically advantageous

Installation

Carefully clean the hub and shaft contact surfaces and apply a light oil film. Slide the locking elements into the hub bore, insert the shaft and tighten gradually and regularly in crossed sequence all screws to reach the tightening torque M_s as indicated in the table. The values M_t and F_{ax} indicated in the table are valid only in case of oil installation. Do not use any oil with **molybdenum bisulphide** or high pressure additives and not grease. Above substances notably reduce the friction coefficient.

Dismantling

By loosening all tightening screws the locking elements are released and the clamping is free. However in case of difficulties slightly hammer the hub.

Tolerances, surface finish

A good surface finish by the machine tool is sufficient.

Maximum allowable surface finish:

$R_t \text{ max } 6 \mu\text{m}$ ($R_a \text{ } 1 \mu\text{m}$ - $R_z \text{ } 5 \mu\text{m}$)

Maximum permissible tolerances:

shaft h6 - hub H7 (up to 40mm d. diameter)

shaft h8 - hub H8 (over 42mm d. diameter)

M_t transmissible

Nr. 1 TLK 300 $M_t = M_t \text{ cat.}$

Nr. 2 TLK 300 $M_t = M_t \text{ cat.} \cdot 1,55$

Nr. 3 TLK 300 $M_t = M_t \text{ cat.} \cdot 1,85$

Nr. 4 TLK 300 $M_t = M_t \text{ cat.} \cdot 2,02$

DM hub calculation

The pressure P_n in the hub can be compared to the inside pressure on a thick hollow cylinder.

For DM calculation see page 42.

TLK 350

TLK 350 DIMENSIONS

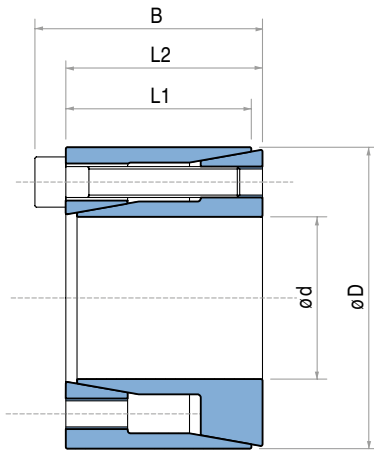

Dimensions				Torque	Axial force	Surface pressures on		Tightening screws		Weight
						Shaft	Hub	DIN912 12.9	Tightening torque	
d x D mm	L1 mm	L2 mm	B mm	M _t Nm	F _{ax} KN	P _w N/mm ²	P _n N/mm ²	N° x Type	M _s Nm	Kg
6 x 16	10,5	11	13,5	9	3,0	184	69	3 x M2,5	1,2	0,012
6,35 x 16	10,5	11	13,5	10	3,0	173	69	3 x M2,5	1,2	0,012
7 x 17	10,5	11	13,5	11	3,0	157	65	3 x M2,5	1,2	0,013
8 x 18	10,5	11	13,5	12	3,0	138	61	3 x M2,5	1,2	0,015
9 x 20	12,5	13	15,5	18	4,0	138	62	4 x M2,5	1,2	0,020
9,53 x 20	12,5	13	15,5	19	4,0	130	62	4 x M2,5	1,2	0,020
10 x 20	12,5	13	15,5	20	4,0	124	62	4 x M2,5	1,2	0,019
11 x 22	12,5	13	15,5	22	4,0	113	56	4 x M2,5	1,2	0,024
12 x 22	12,5	13	15,5	24	4,0	104	56	4 x M2,5	1,2	0,022
14 x 26	16,5	17	20	42	6,0	99	53	4 x M3	2,1	0,039
15 x 28	16,5	17	20	44	6,0	93	50	4 x M3	2,1	0,044
16 x 32	16,5	17	21	83	10,4	152	76	4 x M4	4,9	0,067
17 x 35	20,5	21	25	88	10,4	116	56	4 x M4	4,9	0,090
18 x 35	20,5	21	25	93	10,4	109	56	4 x M4	4,9	0,087
19 x 35	20,5	21	25	99	10,4	104	56	4 x M4	4,9	0,083
20 x 38	20,5	21	26	170	17,0	161	85	4 x M5	10	0,100
22 x 40	20,5	21	26	187	17,0	146	80	4 x M5	10	0,110
24 x 47	25	26	32	287	24,0	153	78	4 x M6	17	0,200
25 x 47	25	26	32	299	24,0	147	78	4 x M6	17	0,190
25,4 x 47	25	26	32	304	24,0	144	78	4 x M6	17	0,180
28 x 50	25	26	32	503	36,0	196	110	6 x M6	17	0,220
30 x 55	25	26	32	539	36,0	183	100	6 x M6	17	0,270
32 x 55	25	26	32	575	36,0	172	100	6 x M6	17	0,250
35 x 60	30	31	37	838	48,0	176	102	8 x M6	17	0,360
38 x 65	30	31	37	910	48,0	162	95	8 x M6	17	0,430
40 x 65	30	31	37	958	48,0	154	95	8 x M6	17	0,400
42 x 75	35	36	44	1394	66,3	175	98	6 x M8	41	0,670
45 x 75	35	36	44	1493	66,3	163	98	6 x M8	41	0,630
48 x 80	35	36	44	2124	88,5	204	122	8 x M8	41	0,740
50 x 80	35	36	44	2212	88,5	196	122	8 x M8	41	0,700

Characteristics

- Medium-high torque
- Easy mounting
- Limited installation time
- Few clamping screws

Installation

Carefully clean the hub and shaft contact surfaces and apply a light oil film. Slide the locking assembly into the hub bore, insert the shaft and tighten gradually and regularly in crossed sequence all screws to reach the tightening torque M_s as indicated in the table. The values M_t and F_{ax} indicated in the table are valid only in case of oil installation.

Do not use any oil with **molibdenum bisulphide** or high pressure additives and not grease. Above substances notably reduce the friction coefficient.

Dismantling

Loosen the clamping screws. Insert the screws into the dismantling threading and tighten gradually and regularly in crossed sequence until the back cone is released. If the element is to be reused, relubricate both screws and threads.

Tolerances, surface finish

A good surface finish by the machine tool is sufficient.

Maximum allowable surface finish:

Rt max 16 μm (Ra 3 μm - Rz 13 μm)

Maximum permissible tolerances:

h8 for shaft

H8 for hub

Axial movement

TLK 350: during screws tightening the hub has a slight axial movement with respect to the shaft.

DM hub calculation

The pressure P_n in the hub can be compared to the inside pressure on a thick hollow cylinder.

For DM calculation see page 42.

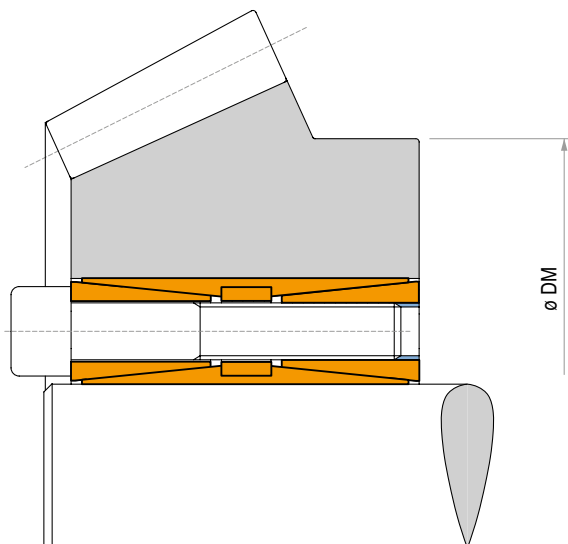

Characteristics

- Very high torques
- Capacity to withstand bending moments
- Even pressures distribution
- No shaft-hub axial movement

Installation

Carefully clean the hub and shaft contact surfaces and apply a light oil film. Slide the locking assembly into the hub bore and insert the shaft. Tighten gradually and regularly in crossed sequence all screws up to 50% of the M_s value indicated in the table. Repeat the same operation by tightening all screws at the M_s torque indicated in the table.

Starting from the last tightened screw, check, in continuous sequence, that all the screws are tightened at the tightening torque M_s indicated. Repeat this procedure maximum twice. After this control any further operation is needed. Do not use any oil with **molybdenum bisulphide** or high pressure additives and not grease. Above substances notably reduce the friction coefficient.

Dismantling

Loosen the clamping screws. Insert the screws into the dismantling threads of the front cone and tighten them gradually in crossed sequence up to 50% of the M_s value indicated in the table. Repeat the same operation by tightening the screws at the tightening torque M_s indicated in the table. When the front cone is loose, to release the rear cone, insert the screws in the middle ring, and repeat the same operation of the upper ring.

Tolerances, surface finish

A good surface finish by the machine tool is sufficient.

Maximum allowable surface finish:

Rt max 16 μm (Ra 3 μm - Rz 13 μm)

Maximum permissible tolerances:

h8 for shaft

H8 for hub

Axial movement

During screws tightening the hub has no axial movement with respect to the shaft.

DM hub calculation

For DM calculation see page 42.

Locking assembly - Self-centering

TLK 400

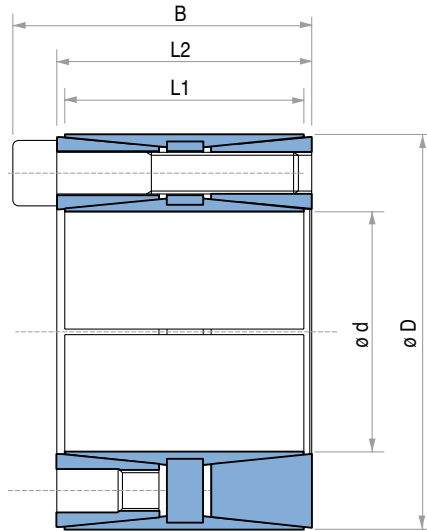

TLK 400 DIMENSIONS

Dimensions				Tightening screws		Torque	Axial force	Surface pressures on		Weight
				DIN912 12.9	Tightening torque			Shaft	Hub	
d x D mm	L1 mm	L2 mm	B mm	N° x Type	M _s Nm	M _t Nm	F _{ax} KN	P _w N/mm ²	P _n N/mm ²	Kg
45 x 75	56	64	72	8 x M8	41	3460	155	165	100	1,3
48 x 80	56	64	72	8 x M8	41	3680	155	150	95	1,5
50 x 80	56	64	72	8 x M8	41	3820	155	147	95	1,4
55 x 85	56	64	72	8 x M8	41	4260	155	135	85	1,5
60 x 90	56	64	72	10 x M8	41	5820	190	155	100	1,5
65 x 95	56	64	72	10 x M8	41	6270	190	140	95	1,6
70 x 110	70	78	88	10 x M10	83	10730	305	170	105	3,0
75 x 115	70	78	88	10 x M10	83	11540	305	155	100	3,1
80 x 120	70	78	88	12 x M10	83	14700	369	175	115	3,5
85 x 125	70	78	88	12 x M10	83	15700	369	165	110	3,5
90 x 130	70	78	88	12 x M10	83	16610	370	157	106	3,8
95 x 135	70	78	88	12 x M10	83	17530	370	150	102	4,0
100 x 145	90	100	112	12 x M12	145	26900	538	160	110	6,0
110 x 155	90	100	112	12 x M12	145	29530	538	143	102	6,2
120 x 165	90	100	112	14 x M12	145	37610	628	154	112	6,8
130 x 180	104	116	130	12 x M14	230	48000	738	143	106	9,8
140 x 190	104	116	130	14 x M14	230	60290	861	160	117	10,2
150 x 200	104	116	130	16 x M14	230	73800	985	165	125	10,9
160 x 210	104	116	130	16 x M14	230	78770	983	155	118	11,5
170 x 225	134	146	162	14 x M16	355	101730	1197	140	108	17,2
180 x 235	134	146	162	16 x M16	355	123200	1369	150	115	18,0
190 x 250	134	146	162	16 x M16	355	129880	1368	141	110	21,5
200 x 260	134	146	162	16 x M16	355	136840	1368	137	104	22,0
220 x 285	134	146	162	20 x M16	355	188000	1710	155	120	25,0
240 x 305	134	146	162	22 x M16	355	225000	1880	155	120	27,0
260 x 325	134	146	162	22 x M16	355	244000	1880	155	115	30,0
280 x 355	165	177	197	20 x M20	690	373000	2670	145	120	46,0
300 x 375	165	177	197	22 x M20	690	440000	2930	155	125	50,0
320 x 405	165	177	197	22 x M20	690	470000	2930	145	115	60,0
340 x 425	165	177	197	24 x M20	690	544000	3200	150	120	65,0
360 x 455	190	202	224	22 x M22	930	658000	3650	140	110	89,0
380 x 475	190	202	224	26 x M22	930	821000	4320	160	130	93,0
400 x 495	190	202	224	26 x M22	930	864000	4320	150	120	98,0

For larger diameter or inch series please contact us.

NOTE: it is possible to reduce the screws tightening torque down to 60% of the values indicated in above table; as a result M_t, F_{ax}, P_w, P_n are reduced proportionally.

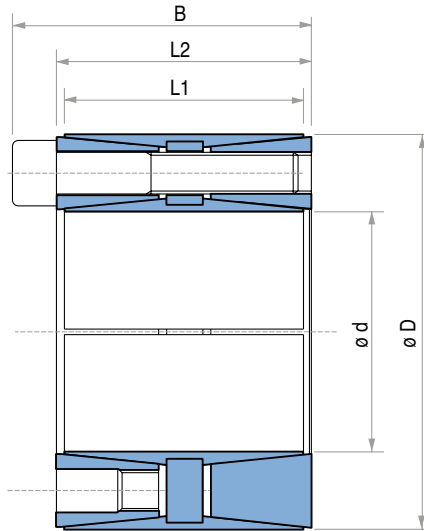

TLK 401 DIMENSIONS

Dimensions				Tightening screws		Torque	Axial force	Surface pressures on		Weight
				DIN 912 12.9	Tightening torque			Shaft	Hub	
d x D mm	L1 mm	L2 mm	B mm	N° x Type	M _s Nm	M _t Nm	F _{ax} KN	P _w N/mm ²	P _n N/mm ²	Kg
70 x 110	50	58	68	8 x M10	83	8620	245	190	120	2.3
75 x 115	50	58	68	8 x M10	83	9160	245	174	115	2.4
80 x 120	50	58	68	8 x M10	83	9840	245	164	110	2.5
85 x 125	50	58	68	10 x M10	83	13000	307	193	130	2.6
90 x 130	50	58	68	10 x M10	83	13700	307	181	125	2.7
95 x 135	50	58	68	10 x M10	83	14540	307	173	122	2.8
100 x 145	60	70	80	10 x M10	83	15380	307	135	93	4.0
110 x 155	60	70	80	10 x M10	83	16900	307	127	88	4.5
120 x 165	60	70	80	12 x M10	83	22150	365	135	100	4.8
130 x 180	68	80	92	12 x M12	145	34860	537	160	116	6.3
140 x 190	68	80	92	12 x M12	145	37550	537	150	111	6.6
150 x 200	68	80	92	12 x M12	145	40250	537	140	105	7.0
160 x 210	68	80	92	14 x M12	145	50180	626	152	116	7.4
170 x 225	75	87	99	16 x M12	145	60960	717	150	113	10.0
180 x 235	75	87	99	16 x M12	145	64500	717	142	108	11.3
190 x 250	88	100	112	18 x M12	145	76620	806	128	98	14.0
200 x 260	88	100	112	18 x M12	145	80660	806	122	95	15.2
220 x 285	98	110	124	14 x M14	230	94730	861	107	83	19.5
240 x 305	98	110	124	18 x M14	230	132830	1100	125	98	21.5
260 x 325	98	110	124	20 x M14	230	159970	1230	128	103	23.0
280 x 355	120	132	148	20 x M16	355	239260	1710	135	106	35.3
300 x 375	120	132	148	24 x M16	355	306650	2050	150	121	37.5
320 x 405	135	147	163	24 x M16	355	326870	2050	127	101	50.7
340 x 425	135	147	163	24 x M16	355	348780	2050	120	96	53.5

For larger diameter or inch series please contact us.

Locking assembly - Self-centering

TLK 450

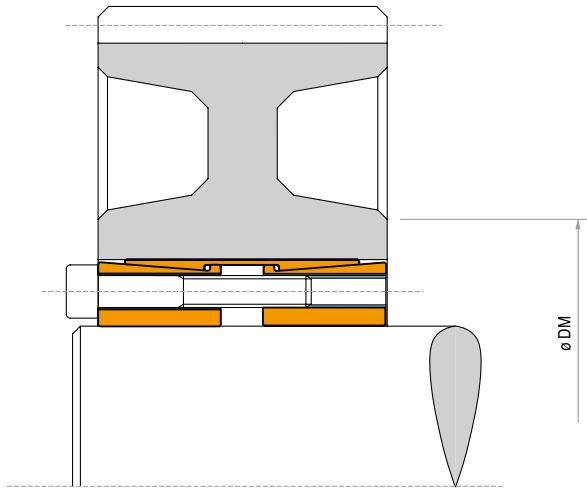

TLK 451

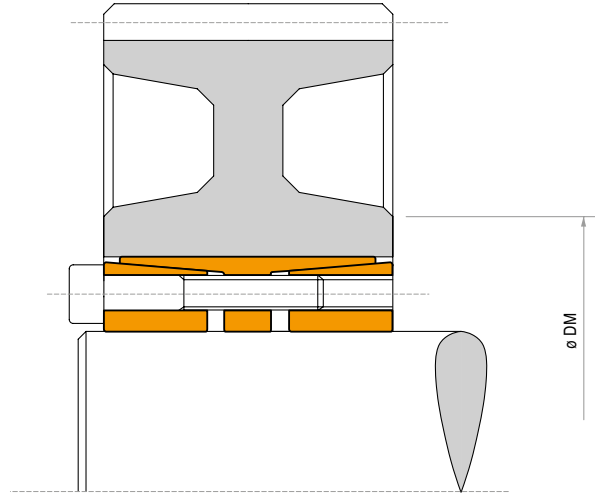

Characteristics

- Very high torques
- Capacity to withstand bending moments
- Standard sizes

Installation

Carefully clean the hub and shaft contact surfaces and apply a light oil film. Slide the locking assembly into the hub bore and insert the shaft. Tighten gradually and regularly in crossed sequence all screws up to 50% of the M_s value indicated in the table. Repeat the same operation by tightening all screws at the M_s torque indicated in the table.

Starting from the last tightened screw, check, in continuous sequence, that all the screws are tightened at the tightening torque M_s indicated. Repeat this procedure maximum twice. After this control any further operation is needed.

Do not use any oil with **molybdenum bisulphide** or high pressure additives and not grease. Above substances notably reduce the friction coefficient.

Dismantling

Loosen the clamping screws. Insert the screws into the dismantling threads of the front cone and tighten them gradually in crossed sequence up to 50% of the M_s value indicated in the table. Repeat the same operation by tightening the screws at the tightening torque M_s indicated in the table.

When the front cone is loose, to release the rear cone:
TLK 450: keep tightening the screws and repeat the sequence above.

TLK 451: insert the screws in the middle flange and repeat the same operation of the upper ring.

Tolerances, surface finish

A good surface finish by the machine tool is sufficient.

Maximum allowable surface finish:
Rt max 16 μm (Ra 3 μm - Rz 13 μm)

Maximum permissible tolerances:
h8 for shaft
H8 for hub

DM hub calculation

For DM calculation see page 42.

ATTENTION: In case of reuse of the TLK 451 check that the position of the dismantling threads of the front cone and middle flange are like in new pieces.

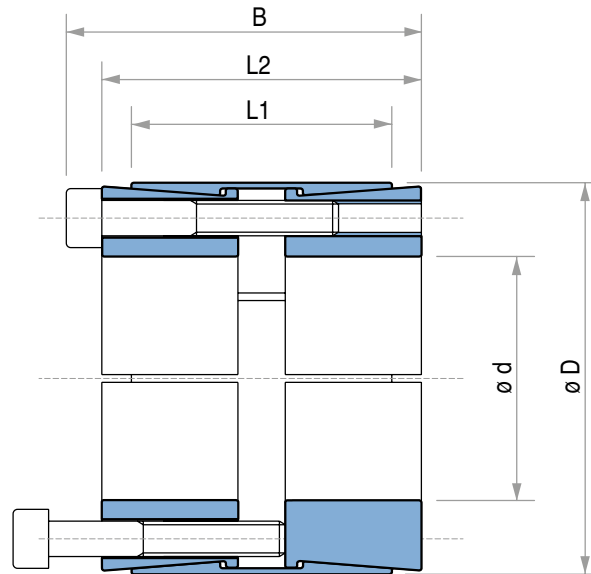

TLK 450 DIMENSIONS

Dimensions				Tightening screws		Torque	Axial force	Surface pressures on		Weight
				DIN912 12.9	Tightening torque			Shaft	Hub	
d x D mm	L1 mm	L2 mm	B mm	N° x Type	M _t Nm	M _t Nm	F _{ax} KN	p _w N/mm ²	p _n N/mm ²	Kg
25 x 50	39	45	51	8 x M6	17	950	76	245	122	0,5
28 x 55	39	45	51	8 x M6	17	1070	76	219	111	0,6
30 x 55	39	45	51	8 x M6	17	1150	76	204	111	0,6
35 x 60	39	45	51	8 x M6	17	1340	76	175	102	0,7
38 x 65	39	45	51	8 x M6	17	1450	76	161	94	0,7
40 x 65	39	45	51	8 x M6	17	1530	76	153	94	0,7
42 x 75	56	64	72	8 x M8	41	2970	141	188	105	1,0
45 x 75	56	64	72	8 x M8	41	3150	141	175	105	0,9
48 x 80	56	64	72	8 x M8	41	4000	166	164	98	1,4
50 x 80	56	64	72	8 x M8	41	4150	166	158	98	1,3
55 x 85	56	64	72	8 x M8	41	4550	166	143	93	1,5
60 x 90	56	64	72	10 x M8	41	6200	207	164	109	1,6
65 x 95	56	64	72	10 x M8	41	6750	207	152	104	1,8
70 x 110	70	78	88	10 x M10	83	11550	330	179	114	3,0
75 x 115	70	78	88	10 x M10	83	12350	330	167	109	3,3
80 x 120	70	78	88	12 x M10	83	15800	396	188	125	3,5
85 x 125	70	78	88	12 x M10	83	16800	396	177	120	3,7
90 x 130	70	78	88	12 x M10	83	17800	396	167	115	3,8
95 x 135	70	78	88	12 x M10	83	18800	396	158	111	5,0
100 x 145	90	100	112	12 x M12	145	28800	576	170	117	6,0
110 x 155	90	100	112	12 x M12	145	31700	576	155	110	6,2
120 x 165	90	100	112	14 x M12	145	40300	673	165	120	7,2
130 x 180	104	116	130	12 x M14	230	51400	791	155	112	10,0
140 x 190	104	116	130	14 x M14	230	64600	923	168	124	10,2
150 x 200	104	116	130	16 x M14	230	79100	1055	179	135	10,8
160 x 210	104	116	130	16 x M14	230	84400	1055	168	128	11,5
170 x 225	134	146	162	14 x M16	355	109000	1283	149	113	17,0
180 x 235	134	146	162	16 x M16	355	132000	1466	161	124	18,5
190 x 250	134	146	162	16 x M16	355	139000	1466	153	116	21,5
200 x 260	134	146	162	16 x M16	355	146500	1466	145	112	22,0
220 x 285	134	146	162	20 x M16	355	201500	1833	165	127	25,0
240 x 305	134	146	162	22 x M16	355	242000	2017	166	131	27,0
260 x 325	134	146	162	22 x M16	355	262000	2017	154	123	30,0
280 x 355	165	177	197	20 x M20	690	400000	2862	164	130	46,0
300 x 375	165	177	197	22 x M20	690	472000	3148	169	135	50,0
320 x 405	165	177	197	22 x M20	690	503500	3148	158	125	60,0
340 x 425	165	177	197	24 x M20	690	583500	3434	162	130	65,0
360 x 455	190	202	224	22 x M22	930	705000	3918	152	120	89,0
380 x 475	190	202	224	26 x M22	930	880000	4631	170	136	93,0
400 x 495	190	202	224	26 x M22	930	926000	4631	162	131	98,0

For larger diameter or inch series please contact us.

NOTE: it is possible to reduce the screws tightening torque down to 60% of the values indicated in above table; as a result M_t, F_{ax}, P_w, P_n are reduced proportionally.

Locking assembly - Self-centering

TLK 451

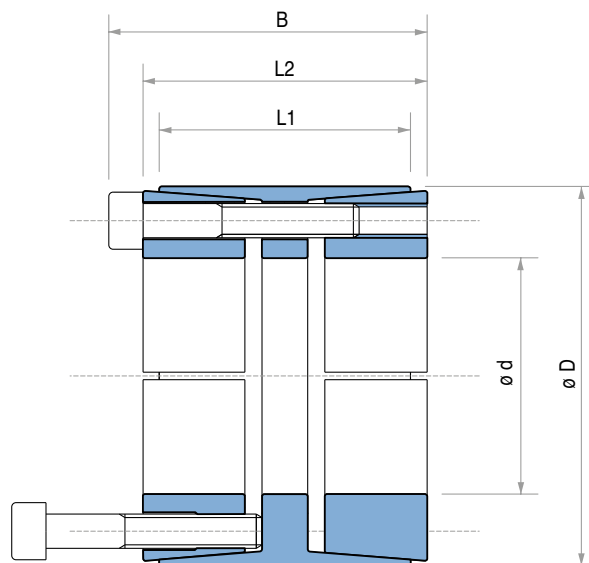

TLK 451 DIMENSIONS

Dimensions				Tightening screws		Torque	Axial force	Surface pressures on		Weight
				DIN 912 12.9	Tightening torque			Shaft	Hub	
d x D mm	L1 mm	L2 mm	B mm	N° x Type	M _s Nm	M _t Nm	F _{ax} KN	P _w N/mm ²	P _n N/mm ²	Kg
70 x 110	50	60	70	8 x M10	83	7090	203	192	109	2.3
80 x 120	50	60	70	10 x M10	83	10130	253	210	124	2.5
90 x 130	50	60	70	11 x M10	83	12540	279	205	126	2.7
100 x 145	60	70	82	10 x M12	145	18440	369	204	125	4.1
110 x 155	60	70	82	10 x M12	145	20200	369	185	117	4.4
120 x 165	60	70	82	11 x M12	145	24300	406	187	121	4.8
130 x 180	65	79	91	14 x M12	145	33500	516	199	129	6.3
140 x 190	65	79	91	15 x M12	145	38700	553	198	131	6.6
150 x 200	65	79	91	15 x M12	145	41400	553	185	124	7.8
160 x 210	65	79	91	16 x M12	145	47200	590	185	126	7.4
170 x 225	78	92	106	15 x M14	230	64500	759	185	126	10.7
180 x 235	78	92	106	15 x M14	230	68300	759	175	121	11.3
190 x 250	88	102	116	16 x M14	230	76900	810	153	106	14.6
200 x 260	88	102	116	18 x M14	230	91100	911	163	115	15.3
220 x 285	96	108	124	15 x M16	355	116000	1055	159	112	20.2
240 x 305	96	108	124	20 x M16	355	168800	1407	194	139	21.8
260 x 325	96	108	124	20 x M16	355	182000	1407	179	130	23.4
280 x 355	96	110	130	15 x M20	690	230000	1647	205	143	30.0
300 x 375	96	110	130	16 x M20	690	263000	1757	204	145	31.2
320 x 405	124	136	156	20 x M20	690	351000	2196	175	126	48.0
340 x 425	124	136	156	20 x M20	690	373000	2196	165	120	51.0
360 x 455	140	155	177	20 x M22	930	492000	2734	171	124	69.0
380 x 475	140	155	177	20 x M22	930	519000	2734	162	118	73.0
400 x 495	140	155	177	22 x M22	930	601000	3007	169	125	76.0
420 x 515	140	155	177	24 x M22	930	688000	3280	176	131	80.0
440 x 535	140	155	177	24 x M22	930	721000	3280	168	126	81.0
460 x 555	140	155	177	24 x M22	930	754000	3280	160	122	85.0
480 x 575	140	155	177	25 x M22	930	820000	3417	160	122	88.0
500 x 595	140	155	177	25 x M22	930	854000	3417	154	118	91.0
520 x 615	140	155	177	28 x M22	930	995000	3827	165	128	95.0
540 x 635	140	155	177	28 x M22	930	1033000	3827	159	124	98.0
560 x 655	140	155	177	30 x M22	930	1148000	4101	165	129	101.0
580 x 675	140	155	177	30 x M22	930	1189000	4101	159	125	104.0
600 x 695	140	155	177	30 x M22	930	1230000	4101	154	121	108.0

For larger diameter or inch series please contact us.

TLK 500 DIMENSIONS

Dimensions			Torque	Axial force	Tightening Screws		Weight
					DIN912 12.9	Tightening torque	
d x D mm	L mm	B mm	M _t Nm	F _{ax} N° x Type	N° x Type	M _s Nm	Kg
17 x 50	50	56	200	24	4 x M6	17	0,5
18 x 50	50	56	220	24	4 x M6	17	0,5
19 x 50	50	56	230	24	4 x M6	17	0,5
20 x 50	50	56	240	24	4 x M6	17	0,5
22 x 55	60	66	260	24	4 x M6	17	0,6
24 x 55	60	66	290	24	4 x M6	17	0,6
25 x 55	60	66	450	36	6 x M6	17	0,6
28 x 60	60	66	510	36	6 x M6	17	0,7
30 x 60	60	66	550	36	6 x M6	17	0,7
32 x 75	60	68	720	45	4 x M8	41	1,3
35 x 75	75	83	790	45	4 x M8	41	1,3
38 x 75	75	83	850	45	4 x M8	41	1,3
40 x 75	75	83	900	45	4 x M8	41	1,3
42 x 90	75	83	1400	67	6 x M8	41	2,8
45 x 90	85	93	1520	67	6 x M8	41	2,5
48 x 90	85	93	1620	67	6 x M8	41	2,4
50 x 90	85	93	1690	67	6 x M8	41	2,3
55 x 105	85	93	2470	90	8 x M8	41	3,3
60 x 105	85	93	2710	90	8 x M8	41	3,2
65 x 105	85	93	2930	90	8 x M8	41	3,0
70 x 125	100	110	3770	107	6 x M10	83	5,4
75 x 125	100	110	4030	107	6 x M10	83	5,0
80 x 125	100	110	4300	107	6 x M10	83	4,7

For larger diameter or inch series please contact us.

Characteristics

- Medium high torque
- Restricted number of tightening screws
- Easy installation
- Application economically advantageous

Installation

Carefully clean the shafts contact surfaces. Fit the rigid coupling at the end of the connecting shafts. Tighten gradually and regularly in crossed sequence all screws to reach the tightening torque M_s indicated on the table.

Dismantling

By loosening all tightening screws the clamping cones are normally released. However in case of difficulties slightly hammer the released screws in a way to push back the rear pressure cone.

Tolerances, surface finish

A good surface finish by the machine tool is sufficient.

Maximum allowable surface finish:

Rt max 16 μm (Ra 3 μm - Rz 13 μm)

Maximum permissible tolerances:

h8 for shaft

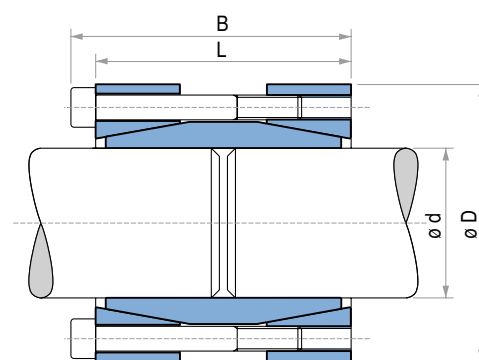

Standard version

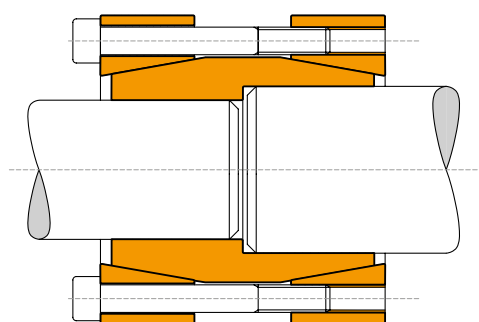

Double diameter versions are available

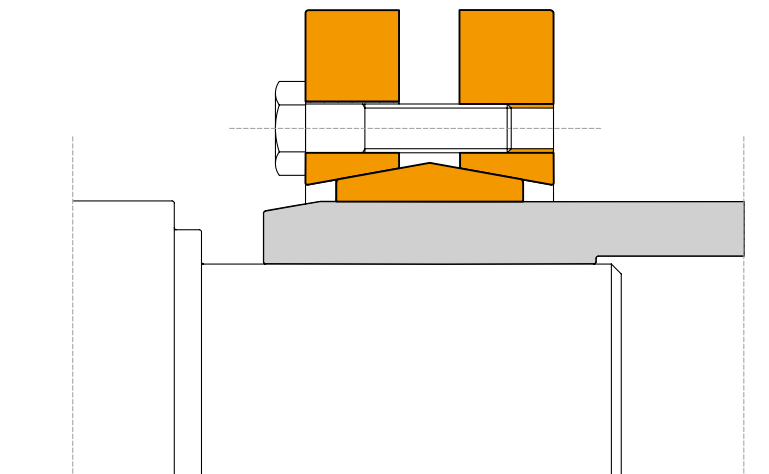

Characteristics

- Medium-high torque
- No shaft-hub axial movement
- Limited installation time
- Quick dismantling

Installation

Carefully clean the hub and shaft contact surfaces. Slide the shrink disc outside the hollow shaft. Tighten gradually and regularly in continuous sequence all screws to reach the tightening torque M_s indicated in the table.

To reach the required tightening torque M_s it is necessary to repeat the procedure more than once.

Do not use **molybdenum bisulphide** in the hub and shaft contact surfaces.

Dismantling

Loosen the clamping screws in a continuous and gradual sequence. Do not remove screws from threads. Normally with this operation the shrink disc is released.

In case of reuse, apply a solid lubricant (that can guarantee a friction coefficient equal to 0,04) in the screws and in the tapered surfaces.

Tolerances, surface finish

A good surface finish by the machine tool is sufficient.

Maximum allowable surface finish:

Rt max 16 μm (Ra 3 μm - Rz 13 μm)

Maximum permissible tolerances:

d = h8 for shaft

Dw diameter tolerances

From 18 mm to 30 mm dw	H6/j6
From 30 mm to 50 mm dw	H6/h6
From 50 mm to 80 mm dw	H6/g6
From 80 mm to 500 mm dw	H7/g6

Axial movement

During screws tightening the hub has no axial movement with respect to the shaft.

Shrink discs - Standard version

TLK 603

TLK 603 DIMENSIONS

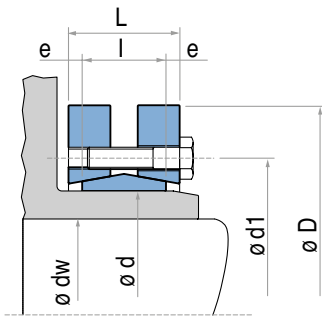

Type	Shaft diameter	Torque	Axial force	Dimensions					Tightening screws		Weight
									DIN931 10.9	Tightening torque	
d mm	dw mm	M _t Nm	F _{ax} KN	D mm	l mm	L mm	d1 mm	e mm	N° x Type	M _t Nm	Kg
14	11	30	6	38	7	11	23	2	4 x M5*	4	0,1
	12	50	9								
16	13	70	10	41	11	15	26	2	5 x M5*	4	0,1
	14	90	13								
24	19	170	25	50	14	19,5	36	2,75	6 x M5*	4	0,2
	20	210	27								
30	21	250	29	60	16	21,5	44	2,75	7 x M5*	4	0,3
	24	300	29								
36	25	340	31	72	18	23,5	52	2,75	5 x M6	12	0,4
	26	380	33								
44	28	440	50	80	20	25,5	61	2,75	7 x M6	12	0,6
	30	570	58								
50	31	630	58	90	22	27,5	70	2,75	8 x M6	12	0,8
	32	620	64								
55	35	780	74	100	23	30,5	75	3,75	8 x M6	12	1,1
	36	860	77								
62	38	940	79	110	23	30,5	86	3,75	10 x M6	12	1,3
	40	1160	86								
68	42	1380	92	115	23	30,5	86	3,75	10 x M6	12	1,4
	42	1160	79								
75	45	1520	88	138	25	32,5	100	3,75	7 x M8	30	1,7
	48	1880	97								
80	48	1850	100	145	25	32,5	100	3,75	7 x M8	30	1,9
	50	2200	111								
85	52	2400	117	155	30	39	114	4,5	10 x M8	30	3,5
	50	2000	97								
90	55	2500	106	155	30	39	114	4,5	10 x M8	30	3,3
	60	3150	120								
90	55	2500	119	170	34	44	124	5	12 x M8	30	4,7
	65	3950	155								
100	60	3200	137	185	39	50	136	5,5	9 x M10	59	5,9
	60	3200	124								
100	65	3900	140	188	39	50	141	5,5	9 x M10	59	5,5
	70	4600	158								
110	65	4800	175	215	42	54	160	6	12 x M10	59	9
	75	7400	216								
115	65	4750	170	215	42	54	160	6	12 x M10	59	8,3
	75	7250	210								
120	70	6000	190	215	42	54	160	6	12 x M10	59	8
	70	6900	195								
125	75	7500	220	230	46	60,5	175	7,25	10 x M12	100	10
	80	9000	240								
130	75	7200	229	230	46	60,5	175	7,25	10 x M12	100	10
	80	9000	252								
130	80	9000	252	265	50	64,5	192	7,25	12 x M12	100	15
	85	10800	262								
135	80	7400	235	265	50	64,5	192	7,25	12 x M12	100	14,5
	85	11000	296								
140	85	13300	314	290	56	71	210	7,5	8 x M16	250	22
	90	14500	340								
140	85	11000	296	290	56	71	210	7,5	8 x M16	250	22
	95	15000	352								
140	90	11300	304	290	56	71	210	7,5	8 x M16	250	22
	95	13300	333								
140	95	15100	367	290	56	71	210	7,5	8 x M16	250	22
	100	15400	362								
145	95	15100	367	290	56	71	210	7,5	8 x M16	250	22
	100	17600	396								
150	105	20100	425	290	56	71	210	7,5	8 x M16	250	22
	105	22000	447								
155	105	22000	447	290	56	71	210	7,5	8 x M16	250	22
	110	25000	478								
155	110	28000	509	290	56	71	210	7,5	8 x M16	250	22
	110	22600	460								
160	115	25700	490	290	56	71	210	7,5	8 x M16	250	22
	115	31000	595								
165	120	28800	520	290	56	71	210	7,5	8 x M16	250	22
	115	31000	595								
165	120	35000	630	290	56	71	210	7,5	8 x M16	250	22
	125	39000	655								

* 8.8.
Fortsetzung folgt.

TLK 603 DIMENSIONS

Type	Shaft diameter	Torque	Axial force	Dimensions					Tightening screws		Weight	
									DIN931 10.9	Tightening torque		
				d mm	d _w mm	M _t Nm	F _{ax} KN	D mm	l mm	L mm		d1 mm
170	120	31900	610									
	125	36000	640	290	56	71	210	7,5		8 x M16	250	21
	130	40100	670									
	125	36000	605									
175	130	41000	639	300	56	71	220	7,5		8 x M16	250	22
	135	45000	675									
	130	37000	800									
180	135	42200	840	300	56	71	220	7,5		8 x M16	250	21
	140	46300	885									
	135	52000	778									
185	140	57000	819	330	71	86	236	7,5		10 x M16	250	37
	145	62000	861									
	140	53500	800									
190	145	58700	840	330	71	86	236	7,5		10 x M16	250	36
	150	63800	885									
	140	65000	933									
195	150	76000	1025	350	71	86	246	7,5		12 x M16	250	41
	155	81500	1071									
	150	74000	990									
200	155	80000	1035	350	71	86	246	7,5		12 x M16	250	41
	160	86000	1080									
	160	95000	1190									
220	165	102000	1239	370	88	104	270	8		15 x M16	250	54
	170	110000	1290									
	170	120000	1464									
240	180	138000	1576	405	92	109	295	8,5		12 x M20	490	67
	190	156000	1675									
	190	164000	1760									
260	200	184000	1880	430	103	120	321	8,5		14 x M20	490	82
	210	205000	2010									
	210	217000	2090									
280	220	244000	2220	460	114	134	346	10		16 x M20	490	102
	230	270000	2350									
	230	275000	2431									
300	240	295000	2567	485	122	142	364	10		18 x M20	490	118
	245	315000	2636									
	240	312000	2647									
320	250	340000	2786	520	122	142	386	10		20 x M20	490	131
	260	374000	2900									
	250	390000	3119									
340	260	422500	3249	570	134	156	408	11		24 x M20	490	186
	270	460000	3400									
	270	442000	3276									
350	280	480000	3430	580	140	162	432	11		24 x M20	490	195
	285	500000	3500									
	280	463000	3310									
360	290	502000	3461	590	140	162	432	11		24 x M20	490	204
	295	522000	3536									
	290	567000	3910									
380	300	610000	4080	645	144	168	458	12		20 x M24	840	239
	310	658000	4248									
	300	624000	4160									
390	310	671000	4330	660	144	168	468	12		21 x M24	840	260
	320	718000	4484									
	315	670000	4260									
400	320	695000	4345	680	144	168	480	12		21 x M24	840	280
	330	744000	4500									
	330	780000	4850									
420	340	840000	5040	690	164	188	504	12		24 x M24	840	316
	350	900000	5220									
	340	806000	4740									
440	350	860000	4910	750	177	202	527	12,5		24 x M24	840	408
	360	917000	5090									
	360	1000000	5670									
460	370	1070000	5860	770	177	202	547	12,5		28 x M24	840	420
	380	1140000	6050									
	380	1170000	6150									
480	390	1240000	6350	800	188	213	570	12,5		30 x M24	840	505
	400	1310000	6550									

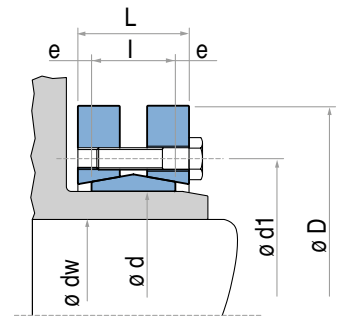

For larger diameter please contact us.

Shrink discs - Heavy version

TLK 602

TLK 602 DIMENSIONS

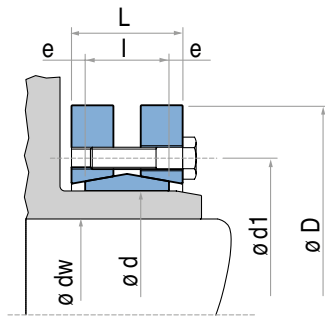

Type	Shaft diameter	Torque	Axial force	Dimensions					Tightening screws		Weight
									DIN931 10.9	Tightening torque	
d mm	dw mm	M _t Nm	F _{ax} KN	D mm	l mm	L mm	d1 mm	e mm	N° x Type	M _t Nm	Kg
125	85	15000	355								
	90	17500	388	215	55	65	160	5	10 x M12	100	11
	95	20000	422								
	95	20600	433								
140	100	23500	469	230	60	74	175	7	12 x M12	100	13
	105	26500	500								
	105	28600	550								
155	110	32500	590	265	66	80	198	7	15 x M12	100	20
	115	36400	630								
	115	41000	740								
165	120	46000	785	290	72	88	210	8	10 x M16	250	26
	125	50700	815								
	125	47000	750								
175	130	52000	795	300	72	88	220	8	10 x M16	250	29
	135	57000	840								
	135	72000	1100								
185	140	78000	1150	330	92	112	236	10	14 x M16	250	47
	145	86000	1200								
	140	75000	1075								
195	150	88000	1180	350	92	112	246	10	14 x M16	250	53
	155	96000	1235								
	145	85000	1170								
200	150	92500	1230	350	92	112	246	10	15 x M16	250	50
	155	100000	1290								
	160	127000	1590								
220	165	136000	1650	370	114	134	270	10	20 x M16	250	65
	170	146500	1720								
	170	155000	1820								
240	180	176000	1960	405	120	144	295	12	15 x M20	490	87
	190	198000	2080								
	190	213000	2260								
260	200	240000	2420	430	136	160	321	12	18 x M20	490	100
	210	268000	2580								
	210	285000	2740								
280	220	320000	2910	460	148	172	346	12	21 x M20	490	132
	230	355000	3090								
	230	341000	2960								
300	240	376000	3130	485	152	176	364	12	22 x M20	490	140
	245	394000	3215								
	240	378000	3150								
320	250	415000	3325	520	160	184	386	12	24 x M20	490	165
	260	451000	3470								
	250	489500	3910								
340	260	530000	4075	570	176	200	420	12	21 x M24	840	240
	270	578000	4275								
	270	556000	4122								
350	280	604000	4320	580	176	200	425	12	21 x M24	840	247
	285	629000	4415								
	280	612000	4370								
360	290	663000	4570	590	180	204	432	12	22 x M24	840	250
	295	689000	4670								
	290	618000	4270								
380	300	668000	4455	645	180	204	458	12	22 x M24	840	320
	310	719000	4645								
	300	708000	4715								
390	310	762000	4910	660	188	212	468	12	24 x M24	840	350
	320	814500	5090								
	315	765000	4855								
400	320	788000	4927	680	188	212	480	12	24 x M24	840	370
	330	845000	5125								
	330	999000	6055								
420	340	1068000	6285	690	214	238	504	12	30 x M24	840	410
	350	1140000	6515								
	340	1058000	6230								
440	350	1130000	6460	750	224	252	527	14	24 x M27	1250	525
	360	1204000	6690								
	360	1320000	7440								
460	370	1420000	7700	770	224	252	547	14	28 x M27	1250	540
	380	1500000	7950								

For larger diameter please contact us.

TLK 601 DIMENSIONS

Type	Shaft diameter	Torque	Axial force	Dimensions					Tightening screws		Weight	
									DIN931 10.9	Tightening torque		
				d mm	d _w mm	M _t Nm	F _{ax} KN	D mm	l mm	L mm		d1 mm
125	95	10550	220									
	100	12100	240	185	39	51	158	6		8 x M10	59	6
	105	13800	260									
	110	14800	265									
140	120	18640	310	220	39	51	175	6		9 x M10	59	8
	125	20500	325									
	130	24000	365									
155	135	26400	390	245	39	51	192	6		11 x M10	59	10
	140	29000	410									
	135	32000	475									
165	140	35200	500	260	46	62	210	8		10 x M12	100	14
	145	38500	530									
	145	39000	535									
175	150	42400	560	275	46	62	220	8		11 x M12	100	16
	155	46000	590									
	155	46600	600									
185	160	50300	625	295	46	62	225	8		12 x M12	100	20
	165	54000	650									
	165	63000	760									
195	170	67700	795	315	56	72	237	8		15 x M12	100	27
	175	72500	825									
	175	74000	850									
200	180	79500	890	330	56	72	242	8		16 x M12	100	30
	185	84500	915									
	180	82800	920									
220	190	93500	980	345	66	84	265	9		10 x M16	250	35
	200	105000	1055									
	200	113000	1135									
240	210	127500	1210	370	66	84	290	9		12 x M16	250	44
	215	134500	1250									
	220	149000	1350									
260	230	165000	1435	395	72	92	310	10		14 x M16	250	48
	235	173000	1475									
	230	171000	1485									
280	240	189000	1570	425	84	104	333	10		16 x M16	250	60
	250	208000	1660									
	250	215000	1720									
300	260	234000	1800	460	84	104	358	10		18 x M16	250	75
	270	255000	1890									
	270	260000	1940									
320	280	284000	2030	495	84	106	378	11		20 x M16	250	84
	290	306000	2125									
	290	300000	2070									
340	300	324400	2160	535	84	106	402	11		21 x M16	250	100
	305	337000	2210									
	300	372000	2485									
350	305	385000	2540	545	100	122	413	11		16 x M20	490	120
	310	400000	2590									
	300	360000	2400									
360	310	388000	2500	555	100	122	423	11		16 x M20	490	125
	320	415000	2590									
	320	435000	2720									
380	325	451000	2780	585	112	136	442	12		18 x M20	490	150
	330	467000	2835									
	330	505000	3060									
390	340	540000	3175	595	112	136	452	12		20 x M20	490	156
	350	577000	3295									
	340	550000	3235									
400	350	587000	3360	615	112	136	462	12		21 x M20	490	170
	360	626000	3480									
	350	578000	3300									
420	360	617000	3425	630	120	144	485	12		22 x M20	490	185
	370	655000	3545									
	370	677000	3660									
440	380	719000	3785	660	120	144	505	12		24 x M20	490	205
	390	762000	3910									
	390	840000	4320									
460	400	890000	4460	685	132	158	527	13		28 x M20	490	235
	410	935000	4580									

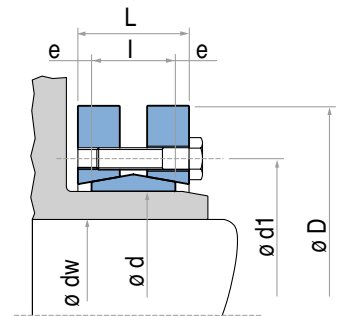

For larger diameter please contact us.

Shrink discs

Special applications

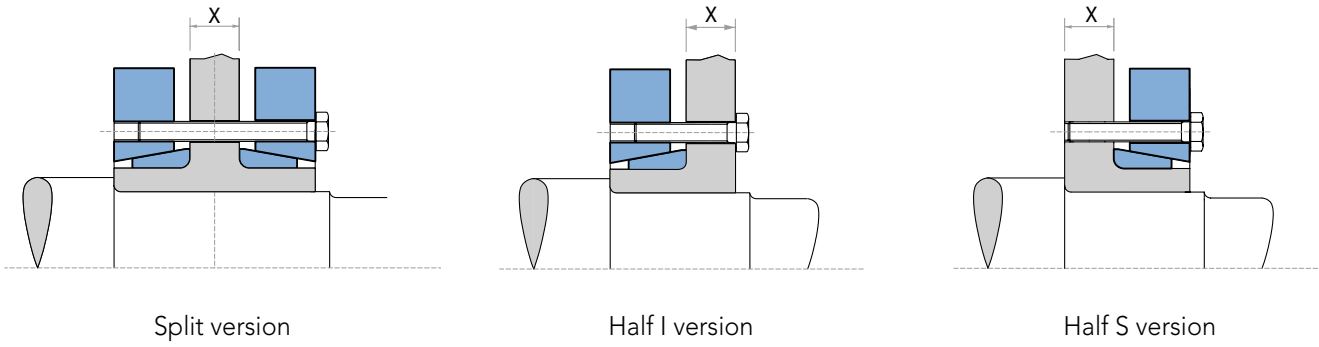

When ordering please specify X dimension

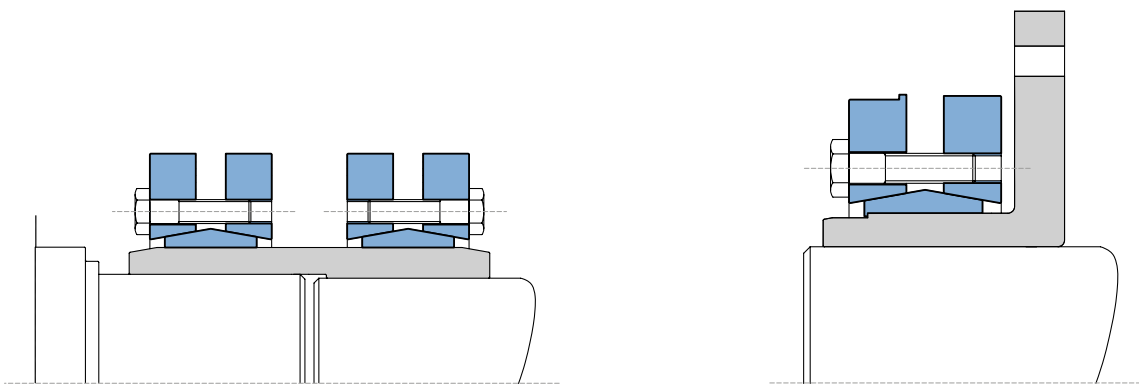

Use of model TLK 603 as coupling between different size shafts

Special version equipped with housing for brake

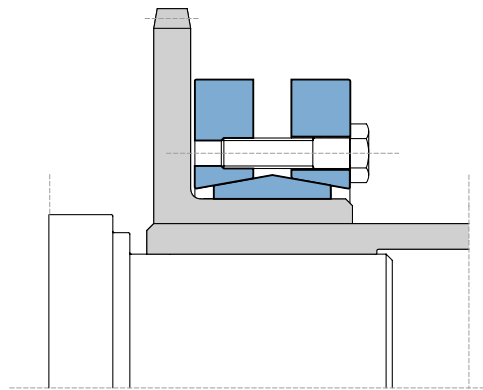

Contemporaneous locking of a sprocket and a hollow shaft.

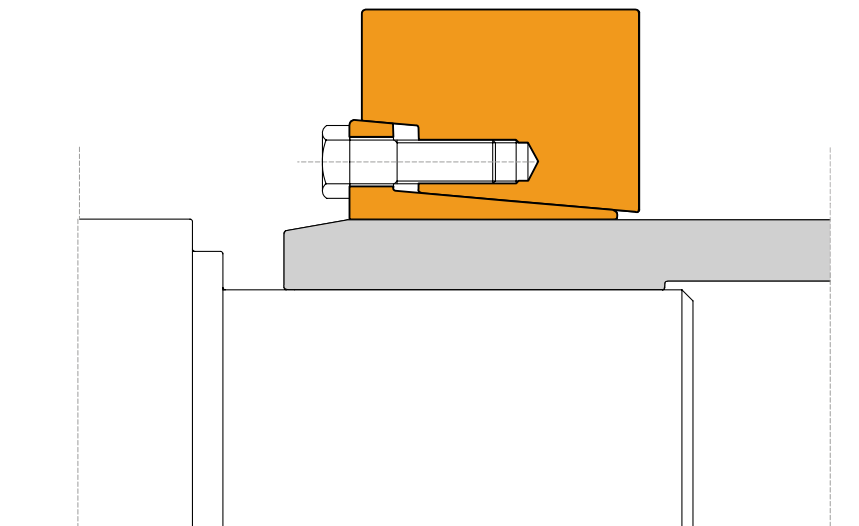

Characteristics

- Very high torques
- No shaft-hub axial movement
- Limited installation time
- Quick dismantling

Installation

Carefully clean the hub and shaft contact surfaces. Slide the shrink disc outside the hollow shaft. Tighten gradually and regularly in continuous sequence all screws to reach the tightening torque M_s indicated in the table.

To reach the required tightening torque M_s it is necessary to repeat the procedure more than once.

Do not use **molybdenum bisulphide** in the hub and shaft contact surfaces.

Dismantling

Loosen the clamping screws in a continuous and gradual sequence. Do not remove screws from threads. Normally with this operation the shrink disc is released.

In case of reuse, apply a solid lubricant (that can guarantee a friction coefficient equal to 0,04) in the screws and in the tapered surfaces.

Tolerances, surface finish

A good surface finish by the machine tool is sufficient.

Maximum allowable surface finish:

R_t max 16 μm (R_a 3 μm - R_z 13 μm)

Maximum permissible tolerances:

$d = f7$ for shaft

Dw diameter tolerances

dw: Up to 150 mm H7/h6

From 155 mm H7/g6

Axial movement

During screws tightening the hub has no axial movement with respect to the shaft.

Shrink discs

TLK 622

TLK 681

TLK 622 - TLK 681 DIMENSIONS

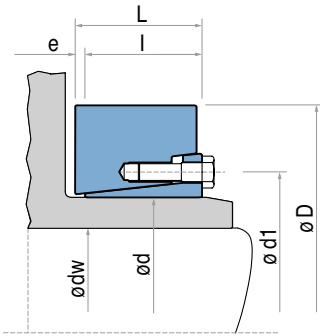

Type	Shaft diameter	TLK 622			TLK 681			Dimensions					Tightening screws DIN931 Type	Weight Kg	
		Torque M _t Nm	Axial force F _{ax} KN	Tightening torque M _s Nm	Torque M _t Nm	Axial force F _{ax} KN	Tightening torque M _s Nm	D mm	I mm	L mm	d1 mm	e mm			
	9	20	5												
12	10	40	8	12				38	10	11	24	1	M6	0,1	
	11	30	6												
14	12	50	9	12				38	10	11	26	1	M6	0,1	
	13	70	10												
16	14	90	13	12				41	13,5	15	28	1,5	M6	0,1	
	15	80	11												
18	16	110	14	12				44	13,5	15	30	1,5	M6	0,1	
	17	150	18												
20	18	180	20	12				47	13,5	15	32	1,5	M6	0,1	
	19	160	17												
24	20	210	20	12				50	16	18	36	2	M6	0,2	
	22	280	25												
	24	270	23												
30	25	320	25	12				60	18	20	44	2	M6	0,3	
	26	360	28												
	27	440	32												
36	30	610	41	30				72	20	22	52	2	M8	0,5	
	33	820	50												
	34	690	41												
44	35	770	44	30				80	22	24	61	2	M8	0,6	
	37	920	50												
	38	1110	58		1500	78									
50	40	1290	65	30	1700	85	35	90	23,5	26	68	2,5	M8	0,8	
	42	1510	71		1900	93									
	42	1230	59		1600	78									
55	45	1530	68	30	2000	88	35	100	26	29	72	3	M8	1,1	
	48	1860	78		2400	99									
	48	1670	70		2200	91									
62	50	1890	76	30	2400	98	35	110	26	29	80	3	M8	1,3	
	52	2120	81		2700	104									
	50	1870	75		2400	94									
68	55	2450	89	30	3000	111	35	115	26	29	86	3	M8	1,3	
	60	3120	104		3800	127									
	55	2330	85		3700	136									
75	60	3020	101	59	4700	157	70	138	27	31	100	4	M10	2,3	
	65	3810	117		5800	178									
	60	3190	106		4200	142									
80	65	4060	123	59	5200	161	70	141	27	31	104	4	M10	2,3	
	70	4910	140		6300	181									
	65	5400	166		5900	181									
90	70	6500	187	59	7100	203	70	155	34	38	114	4	M10	3,2	
	75	7800	208		8500	226									
	70	6000	171		7400	213									
100	75	7200	192	59	8900	237	70	170	39	43	124	4	M10	4,3	
	80	8500	213		10400	261									
	80	10000	249		12600	314									
110	85	11700	275	100	14600	344	121	185	43,5	49	138	5,5	M12	5,8	
	90	13600	302		16900	375									
	85	11900	280		13600	320									
120	90	13800	307	100	15700	349	121	197	46,5	53	147	6,5	M12	6,9	
	95	15900	334		18000	378									
	90	14400	319		16400	365									
125	95	16500	347	100	18800	395	121	215	46,5	53	152	6,5	M12	8,7	
	100	18700	375		21300	426									
	95	18100	382		20300	427									
135	100	20600	412	160	23000	459	195	230	49,5	58	165	8,5	M14	11	
	110	26000	473		28900	525									
	100	19600	392		23000	459									
140	105	22100	421	160	25800	492	195	230	49,5	58	170	8,5	M14	10	
	115	27600	481		32100	558									
	110	26500	482		31100	565									
155	115	29500	514	160	34500	601	195	263	53,5	62	184	8,5	M14	15	
	125	36100	578		42000	672									
	120	37300	622		44000	734									
165	125	41200	659	250	48500	776	300	290	58	68	198	10	M16	22	
	135	49600	734		58100	860									
	130	45000	692		54000	834									
175	135	49000	730	250	59000	876	300	300	58	68	208	10	M16	23	
	145	58000	805		70000	962									

To be continued...

TLK 622 - TLK 681 DIMENSIONS

Type	Shaft diameter	TLK 622			TLK 681			Dimensions					Tightening screws DIN931	Weight
		Torque	Axial force	Tightening torque	Torque	Axial force	Tightening torque	D	I	L	d1	e		
d mm	dw mm	M _t Nm	F _{ax} KN	M _s Nm	M _t Nm	F _{ax} KN	M _s Nm	D mm	I mm	L mm	d1 mm	e mm	Type	Kg
185	140	64000	916		81000	1157								
	145	70000	961	250	88000	1210	300	320	75	85	222	10	M16	33
	155	82000	1053		102000	1319								
	150	81000	1073		96000	1279								
200	155	87000	1120	250	103000	1333	300	340	75	85	238	10	M16	36
	165	100000	1216		119000	1442								
	160	103000	1283		129000	1615								
220	170	119000	1395	490	149000	1749	570	370	91	103	268	12	M20	53
	180	136000	1509		169000	1883								
	170	122000	1439		151000	1773								
240	180	140000	1555	490	172000	1909	570	405	94	107	288	13	M20	66
	200	179000	1790		218000	2183								
	190	163000	1715		212000	2231								
260	200	184000	1842	490	238000	2385	570	430	105	119	312	14	M20	82
	220	231000	2099		297000	2696								
	210	215000	2051		279000	2661								
280	220	240000	2186	490	311000	2825	570	460	116	132	334	16	M20	103
	240	295000	2458		379000	3156								
	220	270000	2456		332000	3018								
300	230	300000	2605	840	367000	3193	980	485	124	140	360	16	M24	120
	250	363000	2906		443000	3545								
	240	301000	2511		404000	3370								
320	250	332000	2655	840	444000	3549	980	520	124	140	380	16	M24	138
	270	398000	2945		528000	3911								
	250	390000	3118		488000	3905								
340	260	427000	3283	840	533000	4101	980	570	137	155	402	18	M24	189
	280	506000	3617		630000	4498								
	270	493000	3649		616000	4563								
350	280	535000	3825	840	669000	4778	980	580	142	162	414	20	M24	202
	290	580000	4001		725000	5000								
	270	496000	3676		625000	4628								
360	280	539000	3852	840	677000	4839	980	590	142	162	424	20	M24	207
	300	631000	4206		790000	5264								
	290	585000	4034		725000	5000								
380	300	632000	4215	1250	783000	5220	1450	640	146	166	454	20	M27	244
	310	681000	4397		844000	5445								
	290	640000	4411		781000	5384								
390	300	691000	4605	1250	842000	5611	1450	650	146	166	454	20	M27	249
	320	799000	4996		971000	6069								
	320	742000	4640		969000	6057								
420	330	797000	4829	1250	1038000	6290	1450	670	166	186	486	20	M27	285
	350	912000	5209		1183000	6758								
	340	945000	5557		1212000	7128								
440	350	1009000	5764	1250	1292000	7382	1450	720	174	194	506	20	M27	357
	370	1143000	6181		1460000	7891								
	360	1104000	6133		1393000	7739								
460	370	1174000	6345	1250	1479000	7995	1450	770	174	194	534	20	M27	419
	390	1320000	6771		1660000	8511								
	380	1300000	6843		1657000	8721								
480	390	1378000	7066	1640	1754000	8993	1970	800	191	213	552	22	M30	492
	410	1541000	7516		1956000	9542								
	400	1496000	7478		1887000	9435								
500	410	1581000	7711	1640	1992000	9717	1970	850	191	213	572	22	M30	567
	430	1759000	8180		2211000	10283								
	430	1930000	8976		2397000	11150								
530	440	2031000	9234	1640	2521000	11459	1970	910	216	238	606	22	M30	744
	460	2243000	9752		2778000	12078								
	450	2097000	9318		2545000	11313								
560	460	2201000	9572	1640	2671000	11611	1970	940	216	238	632	22	M30	776
	480	2420000	10081		2930000	12210								
	470	2593000	11032		2969000	12636								
590	480	2715000	11314	1640	3108000	12952	1970	960	235	260	664	25	M30	835
	500	2970000	11881		3397000	13587								
	500	2904000	11616		3402000	13608								
620	520	3169000	12190	1640	3708000	14261	1970	1020	261	286	706	25	M30	1064
	540	3447000	12767		4028000	14918								

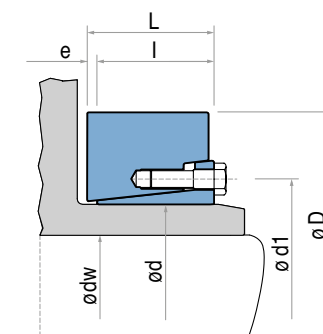

For larger diameter please contact us.

Shrink discs

TLK 623

TLK 623 DIMENSIONS

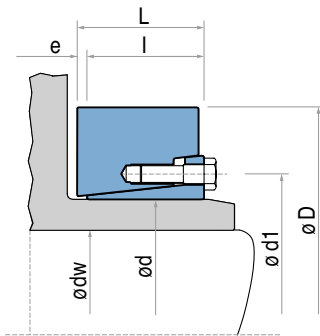

Type	Shaft diameter	Torque	Axial force	Tightening Torque	Dimensions					Tightening screws DIN931	Weight	
					d mm	dw mm	Mt Nm	Fax KN	Ms Nm			D mm
140	100	26000	523									
	105	30000	562	250	230	64	74	174	10	M16	13	
	115	37000	641									
	110	36000	646									
155	115	40000	687	250	263	70	80	194	10	M16	19	
	125	48000	772									
	120	50000	828									
165	125	55000	877	250	290	77	88	204	11	M16	26	
	135	66000	977									
	130	61000	943									
175	135	67000	993	250	300	77	88	214	11	M16	27	
	145	79000	1094									
	140	89000	1269									
185	145	96000	1330	490	320	100	112	232	12	M20	40	
	155	113000	1455									
	150	104000	1391									
200	155	113000	1453	490	340	100	112	246	12	M20	44	
	165	130000	1577									
	160	127000	1591									
220	165	137000	1661	490	370	121	134	266	13	M20	64	
	180	169000	1876									
	170	157000	1847									
240	180	180000	1996	490	405	130	144	286	14	M20	81	
	200	230000	2300									
	190	230000	2424									
260	200	260000	2600	490	430	144	160	306	16	M20	102	
	220	325000	2957									
	210	306000	2918									
280	220	342000	3105	840	460	156	172	334	16	M24	126	
	240	418000	3485									
	230	360000	3132									
300	240	398000	3314	840	485	158	176	354	18	M24	141	
	250	437000	3498									
	240	430000	3580									
320	250	473000	3781	840	520	166	184	374	18	M24	171	
	270	565000	4186									
	250	551000	4407									
340	260	603000	4637	1250	570	186	206	404	20	M27	235	
	280	714000	5100									
	270	671000	4969									
360	280	729000	5204	1250	590	188	210	424	22	M27	251	
	300	852000	5679									
	290	850000	5860									
390	300	917000	6116	1250	650	196	220	456	24	M27	324	
	320	1061000	6633									
	320	1007000	6294									
420	330	1080000	6547	1250	690	221	246	486	25	M27	409	
	350	1235000	7058									
	340	1218000	7166									
440	350	1301000	7433	1640	750	233	258	514	25	M30	526	
	370	1475000	7972									
	360	1402000	7791									
460	370	1491000	8062	1640	770	233	258	534	25	M30	544	
	390	1678000	8606									
	380	1707000	8984									
480	390	1809000	9277	1640	800	270	298	552	28	M30	642	
	410	2023000	9867									
	400	1993000	9963									
500	410	2106000	10273	1640	850	270	300	572	30	M30	741	
	430	2342000	10895									
	430	2549000	11857									
530	440	2683000	12196	2210	890	306	338	616	32	M33	899	
	460	2962000	12878									
	450	2837000	12609									
560	460	2978000	12950	2210	940	306	338	646	32	M33	1000	
	480	3272000	13634									

For larger diameter please contact us.

Locking Assemblies

Calculation of minimum hub diameter DM

By installing TOLLOK locking assemblies the surface pressure P_n , existing between the clamping outer ring and related hub bore, generate a stress. To calculate the minimum hub diameter **DM** the formula normally

used for thick hollow cylinder is valid. Depending from hub shape and length with respect to the dimension **L1** of locking assemblies, the real stresses change. Factor **C** must be considered in function of application type.

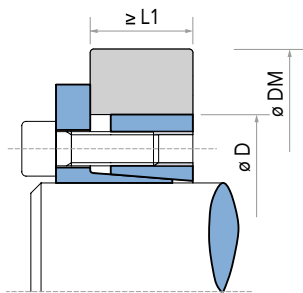

C=1

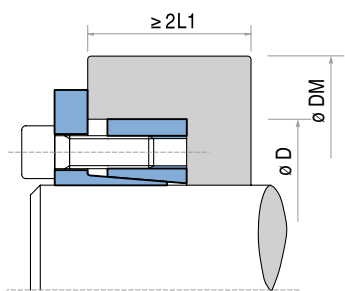
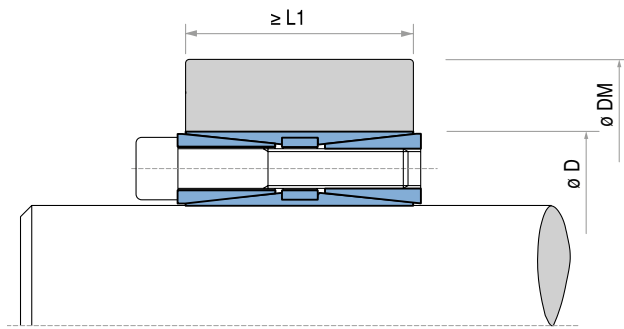

C=0,8

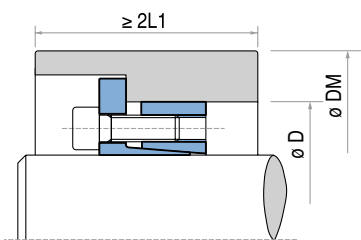
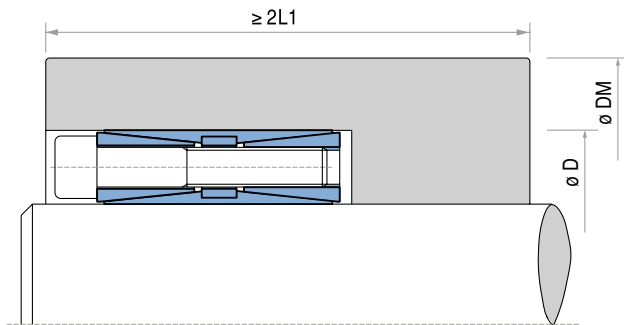

C=0,6

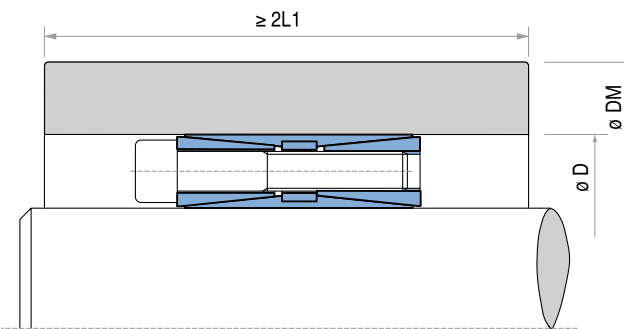

For minimum hub diameter **DM** calculation following formula must be applied:

$$DM \geq D \cdot K$$

where K is equal to:
$$K = \sqrt{\frac{\sigma_{02} + (C \cdot P_n)}{\sigma_{02} - (C \cdot P_n)}}$$

To simplify the calculation our technical department has prepared the table on page 43.

Example:

Locking Assembly type TOLLOK TLK 131 ϕ 60x90.
 Hub pressure $P_n = 83 \text{ N/mm}^2$ (see table page 11).
 Hub material GGG40 (yielding limit $\sigma_{02} = 250 \text{ N/mm}^2$).
 Hub length and shape equivalent $C = 1$.

$$DM \geq 90 \cdot 1,42 \geq 127,8 \text{ mm}$$

Calculation of minimum hub diameter DM

TABLE OF COEFFICIENT K

Pressure generated on the hub		σ_{02} Yield point N/mm ²										
		150	180	200	220	250	270	300	350	400	450	600
p_1 N/mm ²	Application Type C	GG20	GG25 GS38	GG30 GTS35	GS45 ST37-2	GGG40 GS52	ST50-2 C35	GGG50 GS60 ST60-2	GGG60 GS62 ST70-2	GGG70 GS70 C60		
		60	C = 0,6	1,28	1,25	1,20	1,18	1,15	1,14	1,12	1,10	1,09
C = 0,8	1,39		1,30	1,24	1,23	1,22	1,20	1,18	1,15	1,12	1,11	1,08
C = 1	1,52		1,42	1,36	1,32	1,28	1,25	1,22	1,18	1,16	1,14	1,10
65	C = 0,6	1,30	1,25	1,22	1,20	1,18	1,15	1,13	1,11	1,10	1,09	1,07
	C = 0,8	1,44	1,35	1,30	1,28	1,24	1,22	1,20	1,16	1,14	1,12	1,09
	C = 1	1,60	1,45	1,40	1,35	1,30	1,28	1,24	1,20	1,18	1,16	1,12
70	C = 0,6	1,34	1,26	1,24	1,22	1,18	1,16	1,15	1,12	1,11	1,10	1,07
	C = 0,8	1,48	1,38	1,34	1,30	1,25	1,23	1,20	1,18	1,15	1,13	1,10
	C = 1	1,65	1,50	1,45	1,40	1,34	1,30	1,26	1,22	1,20	1,17	1,13
75	C = 0,6	1,30	1,28	1,25	1,23	1,20	1,18	1,16	1,14	1,12	1,11	1,08
	C = 0,8	1,52	1,42	1,36	1,32	1,28	1,25	1,22	1,18	1,16	1,14	1,11
	C = 1	1,74	1,55	1,48	1,42	1,36	1,33	1,30	1,25	1,20	1,18	1,13
80	C = 0,6	1,39	1,31	1,28	1,25	1,21	1,20	1,18	1,15	1,13	1,11	1,08
	C = 0,8	1,58	1,45	1,39	1,35	1,30	1,27	1,24	1,20	1,18	1,15	1,11
	C = 1	1,81	1,61	1,53	1,46	1,39	1,36	1,31	1,26	1,22	1,20	1,14
85	C = 0,6	1,42	1,34	1,30	1,27	1,23	1,21	1,19	1,16	1,14	1,12	1,09
	C = 0,8	1,63	1,49	1,42	1,38	1,32	1,29	1,26	1,22	1,19	1,16	1,12
	C = 1	1,90	1,67	1,57	1,50	1,42	1,39	1,34	1,28	1,24	1,21	1,15
90	C = 0,6	1,46	1,36	1,32	1,28	1,25	1,22	1,20	1,17	1,15	1,13	1,09
	C = 0,8	1,69	1,53	1,46	1,40	1,34	1,31	1,28	1,23	1,20	1,18	1,13
	C = 1	2,00	1,73	1,62	1,54	1,46	1,41	1,36	1,30	1,26	1,22	1,16
95	C = 0,6	1,49	1,39	1,34	1,30	1,26	1,24	1,21	1,18	1,15	1,14	1,10
	C = 0,8	1,75	1,57	1,49	1,43	1,37	1,34	1,30	1,25	1,21	1,19	1,14
	C = 1	2,11	1,80	1,68	1,59	1,49	1,44	1,39	1,32	1,27	1,24	1,17
100	C = 0,6	1,53	1,41	1,36	1,32	1,28	1,25	1,22	1,19	1,16	1,14	1,11
	C = 0,8	1,81	1,61	1,53	1,46	1,39	1,36	1,31	1,26	1,22	1,20	1,14
	C = 1	2,24	1,87	1,73	1,63	1,53	1,48	1,41	1,34	1,29	1,25	1,18
105	C = 0,6	1,56	1,44	1,39	1,34	1,29	1,27	1,24	1,20	1,17	1,15	1,11
	C = 0,8	1,88	1,66	1,56	1,50	1,42	1,38	1,33	1,28	1,24	1,21	1,15
	C = 1	2,38	1,95	1,79	1,68	1,56	1,51	1,44	1,36	1,31	1,27	1,19
110	C = 0,6	1,60	1,47	1,41	1,36	1,31	1,28	1,25	1,21	1,18	1,16	1,12
	C = 0,8	1,96	1,71	1,60	1,53	1,44	1,41	1,35	1,29	1,25	1,22	1,16
	C = 1	2,55	2,04	1,86	1,73	1,60	1,54	1,47	1,38	1,33	1,28	1,20
115	C = 0,6	1,64	1,50	1,43	1,36	1,33	1,30	1,26	1,22	1,19	1,17	1,12
	C = 0,8	2,04	1,76	1,64	1,56	1,47	1,43	1,37	1,31	1,26	1,23	1,17
	C = 1	2,75	2,13	1,93	1,79	1,64	1,58	1,50	1,41	1,34	1,30	1,21
120	C = 0,6	1,69	1,53	1,46	1,40	1,34	1,31	1,28	1,23	1,20	1,18	1,13
	C = 0,8	2,13	1,81	1,69	1,60	1,50	1,45	1,39	1,33	1,28	1,24	1,18
	C = 1	3,00	2,24	2,00	1,84	1,69	1,61	1,53	1,43	1,36	1,31	1,22
125	C = 0,6	1,73	1,56	1,48	1,43	1,36	1,33	1,29	1,24	1,21	1,18	1,13
	C = 0,8	2,24	1,87	1,73	1,63	1,53	1,48	1,41	1,34	1,29	1,25	1,18
	C = 1	3,32	2,35	2,08	1,91	1,73	1,65	1,56	1,45	1,38	1,33	1,24
130	C = 0,6	1,78	1,59	1,51	1,45	1,38	1,35	1,30	1,25	1,22	1,19	1,14
	C = 0,8	2,35	1,93	1,78	1,67	1,56	1,50	1,44	1,36	1,30	1,27	1,19
	C = 1	3,74	2,49	2,17	1,97	1,78	1,69	1,59	1,48	1,40	1,35	1,25
135	C = 0,6	1,83	1,62	1,54	1,47	1,40	1,36	1,32	1,27	1,23	1,20	1,15
	C = 0,8	2,48	2,00	1,83	1,71	1,59	1,53	1,46	1,38	1,32	1,28	1,20
	C = 1	4,36	2,65	2,27	2,04	1,83	1,73	1,62	1,50	1,42	1,36	1,26
140	C = 0,6	1,88	1,66	1,56	1,50	1,42	1,38	1,33	1,28	1,24	1,21	1,15
	C = 0,8	2,63	2,07	1,88	1,75	1,62	1,55	1,48	1,39	1,33	1,29	1,21
	C = 1	5,39	2,83	2,38	2,12	1,88	1,78	1,66	1,53	1,44	1,38	1,27
145	C = 0,6	1,94	1,69	1,59	1,52	1,44	1,40	1,35	1,29	1,25	1,22	1,16
	C = 0,8	2,80	2,15	1,94	1,80	1,65	1,58	1,50	1,41	1,35	1,30	1,22
	C = 1	7,68	3,05	2,50	2,21	1,94	1,82	1,69	1,55	1,46	1,40	1,28
150	C = 0,6	2,00	1,73	1,62	1,54	1,46	1,41	1,36	1,30	1,26	1,23	1,16
	C = 0,8	3,00	2,24	2,00	1,84	1,69	1,61	1,53	1,43	1,36	1,31	1,23
	C = 1	-	3,32	2,65	2,30	2,00	1,87	1,73	1,58	1,48	1,41	1,29
155	C = 0,6	2,06	1,77	1,65	1,57	1,48	1,43	1,38	1,31	1,27	1,24	1,17
	C = 0,8	3,25	2,33	2,06	1,89	1,72	1,65	1,55	1,45	1,38	1,33	1,23
	C = 1	-	3,66	2,80	2,40	2,06	1,92	1,77	1,61	1,51	1,43	1,30
160	C = 0,6	2,13	1,81	1,69	1,60	1,50	1,45	1,39	1,33	1,28	1,24	1,18
	C = 0,8	3,55	2,43	2,13	1,94	1,76	1,67	1,58	1,47	1,39	1,34	1,24
	C = 1	-	4,12	3,00	2,52	2,13	1,98	1,81	1,64	1,53	1,45	1,31
165	C = 0,6	2,21	1,86	1,72	1,62	1,52	1,47	1,41	1,34	1,29	1,25	1,18
	C = 0,8	3,96	2,55	2,21	2,00	1,80	1,71	1,60	1,49	1,41	1,35	1,25
	C = 1	-	4,80	3,23	2,65	2,21	2,04	1,86	1,67	1,55	1,47	1,33

ALL AROUND
THE GLOBE,

CUSTOMERS TRUST
OUR PROVEN BRANDS.

WHY CHOOSE REXNORD?

When it comes to providing highly engineered products that improve productivity and efficiency for industrial applications worldwide, Rexnord is the most reliable in the industry. Commitment to customer satisfaction and superior value extend across every business function.

Delivering Lowest Total Cost of Ownership

The highest quality products are designed to help prevent equipment downtime and increase productivity and dependable operation.

Valuable Expertise

An extensive product offering is accompanied by global sales specialists, customer service and maintenance support teams, available anytime.

Solutions to Enhance Ease of Doing Business

Commitment to operational excellence ensures the right products at the right place at the right time.

BIBUS[®]
SUPPORTING YOUR SUCCESS

BIBUS SK, s.r.o
Trnavská 31, SK-94 901 Nitra

Tel.: 037/ 7777 911 Email: sale@bibus.sk
Fax.: 037/ 7777 999 <http://www.bibus.sk>