

ZDE3K*

**EXPLOSION-PROOF
PRESSURE REDUCING VALVES
ATEX, IECEx, INMETRO, PESO
SERIES 10**

**SUBPLATE MOUNTING
ISO 4401-03**

**p max 100 bar
Q max 15 l/min**

OPERATING PRINCIPLE

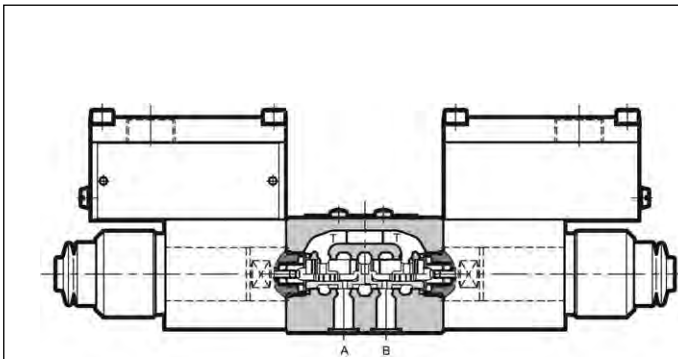

- ZDE3K* are direct operated pressure reducing valves, with electric proportional control, with ISO 4401-03 mounting surface.
- They are compliant with ATEX, IECEx, INMETRO or PESO requirements and are suitable for use in potentially explosive atmospheres, for surface plants or mines.
- A low temperature version (up to -40 °C) is also available.
- The valves are used to reduce pressure in the secondary circuit branches thus ensuring stability of controlled pressure in the event of variations of the flow rate through the valve.
- ZDE3K* valves are supplied with a finishing surface treatment (zinc-nickel) suitable to ensure a salt spray resistance up to 600 hours.
- **Details for classification, operating temperatures and electrical characteristics are in the technical data sheet 02 500 'Explosion proof classification'.**

PERFORMANCES

(obtained with mineral oil with viscosity of 36 cSt at 50°C and electronic control card)

Pressure allowed in P port	bar	30 + 100
Pressure allowed in T port (see par. 2)	bar	0 + 30
Controlled pressure	bar	23
Maximum flow	l/min	15
Step response	ms	30
Hysteresis (with PWM 200 Hz)	% of p nom	< 4%
Repeatability	% of p nom	< ±1%
Electrical characteristic	see paragraph 4	
Operating temperatures (ambient and fluid)	see data sheet 02 500	
Fluid viscosity range	cSt	10 + 400
Fluid contamination degree	According to ISO 4406:1999 class 18/16/13	
Recommended viscosity	cSt	25
Mass: single solenoid valve	kg	1,9
double solenoid valve		2,8

HYDRAULIC SYMBOLS

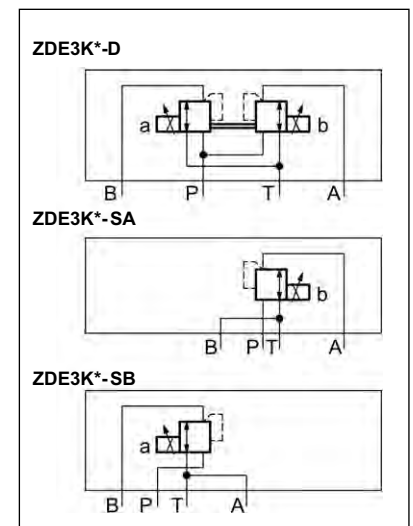



1 - IDENTIFICATION CODE

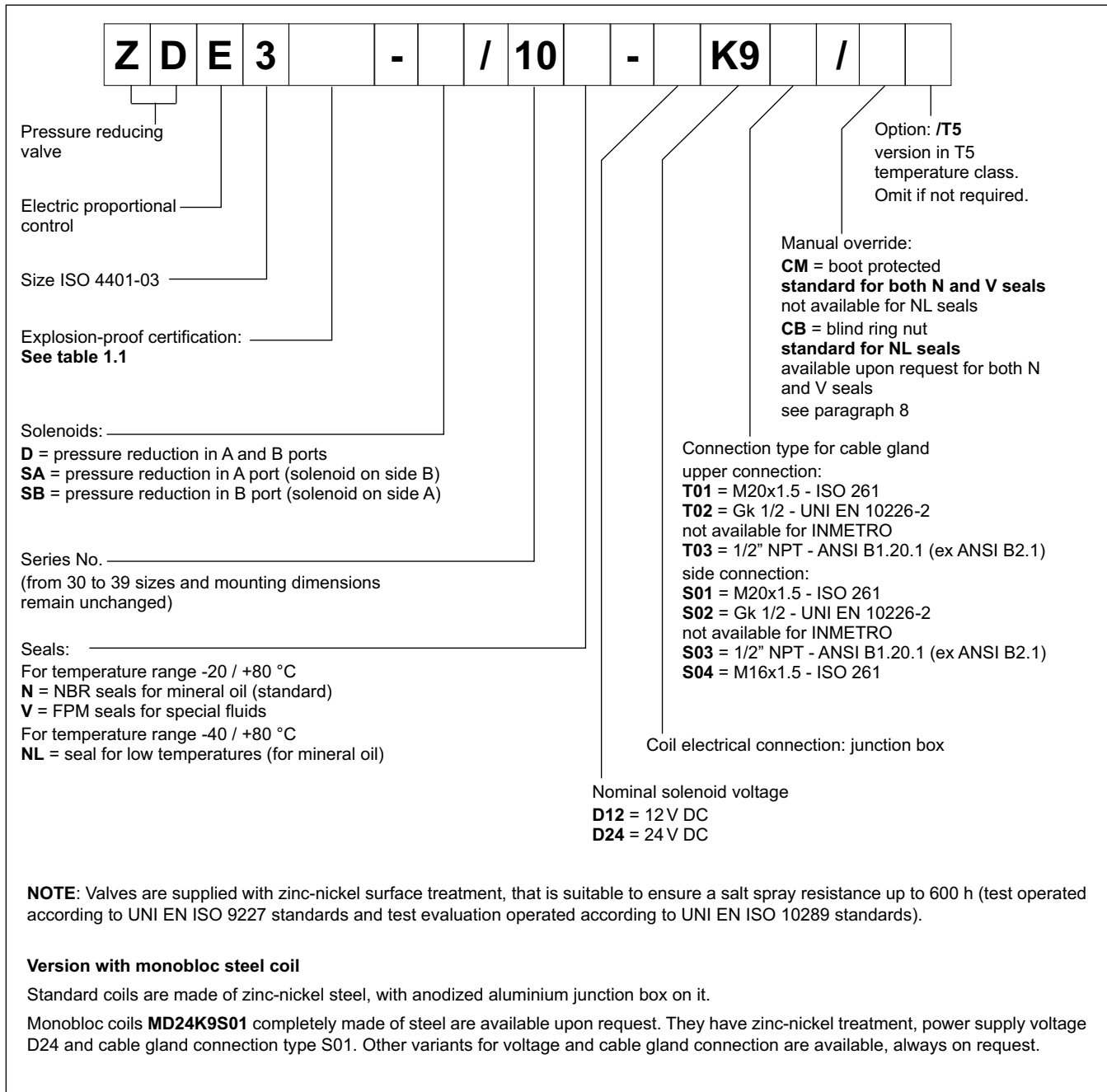

1.1 - Names of valves per certification

	ATEX		IECEX		INMETRO		PESO	
for gases for dusts	KD2	II 2GD	KXD2	IECEX Gb IECEX Db	KBD2	INMETRO Gb INMETRO Db	KPD2	PESO Gb not applicable for dust
for mines	KDM2	I M2	KXDM2	IECEX Mb	KBDM2	INMETRO Mb	not applicable for mines	

NOTE: Refer to the technical data sheet 02 500 for marking, operating temperatures and available versions.

2 - CHARACTERISTIC CURVES

(obtained with ZDE3K*-D/10N-D24K9T01/CM with PWM 100Hz and oil with viscosity 36 cSt at 50°C)

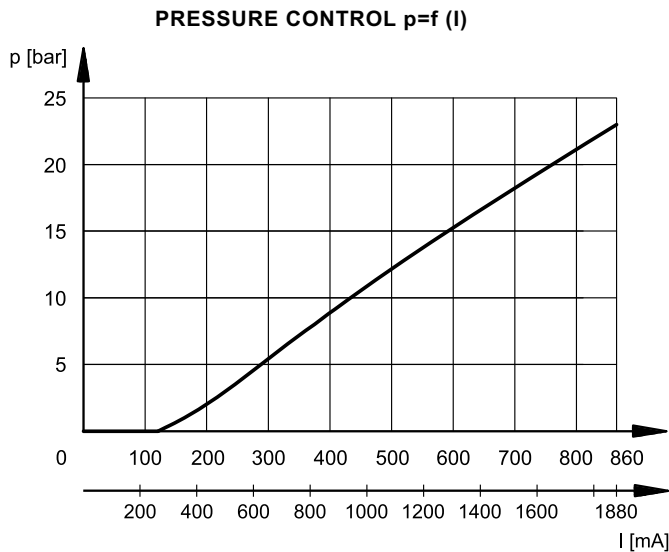

SA and SB versions pressure regulation is less than 0.5 bar.

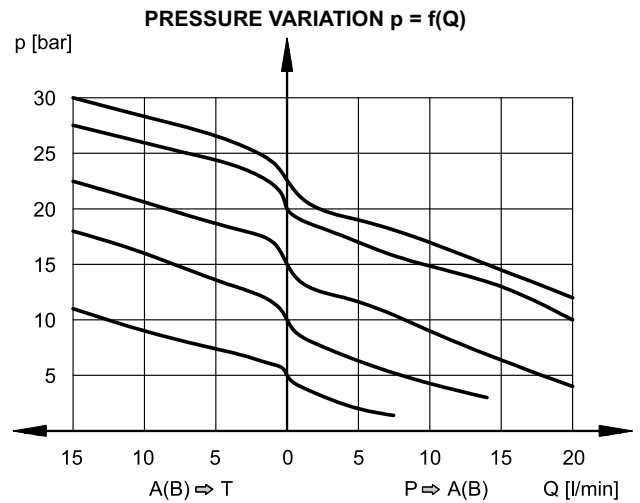

The curves have been obtained with inlet pressure 100 bar.

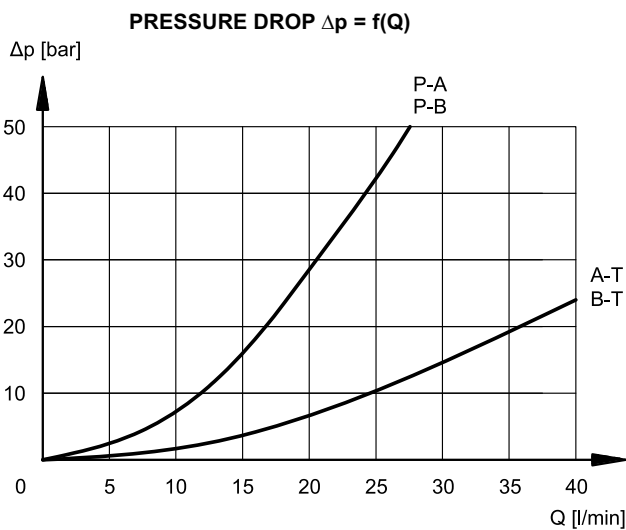

3 - STEP RESPONSE

(obtained with mineral oil with viscosity of 36 cSt at 50°C and electronic control card)

Step response is the time taken for the valve to reach 90% of the set pressure value following a step change of reference signal.

The table illustrates typical step response times measured with input flow rate of $Q = 5$ l/min and $p = 50$ bar.

REFERENCE SIGNAL STEP	0 → 100%	100% → 0
response time [ms]	30	30

4 - ELECTRICAL CHARACTERISTICS

(values $\pm 5\%$)

NOMINAL VOLTAGE	V DC	12	24
RESISTANCE (at 20°C)	Ω	3.8	15.6
NOMINAL CURRENT	A	1.88	0.86
PWM FREQUENCY	Hz	200	100

DUTY CYCLE	100%
ELECTROMAGNETIC COMPATIBILITY (EMC)	According to 2014/30/EU
CLASS OF PROTECTION Atmospheric agents Coil insulation (VDE 0580)	IP66/IP68 class H

4.1 - Wiring

In order to realise the electrical connection of the coil, it is necessary to access the terminal block (1) unscrewing the 4 screws (2) that fasten the cover (3) with the box (4) that contains the terminal block.

The electrical connection is polarity-independent.

By doing electrical connection it is important to connect also the grounding point (5) in the terminal block box (M4 screws), through suitable conductors with the general grounding line of the system.

On the external body of the coil there is a grounding point (6) (M4 screw) that allow to ensure equipotentiality between the valve and the general grounding line of the system; connecting this point the regulation of the EN 13463-1 standard, that impose to verify the equipotentiality of the elements included in a potentially explosive environment (the maximum resistance between the elements must be 100 Ω), is guaranteed.

At the end of the electrical wiring, it is necessary to reassemble the cover (3) on the box (4), checking the correct positioning of the seal located in the cover seat and fastening the 4 M5 screws with a torque of 4.9 + 6 Nm.

Electrical wiring must be done following in compliance with standards about protection against explosion hazards.

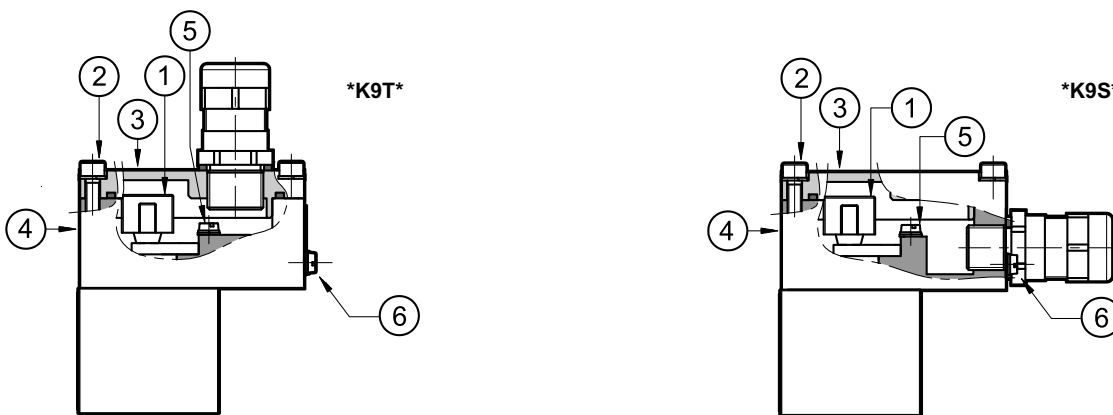

Characteristics of the cables connectable for wiring are indicated in the table below:

Function	Cable section
Operating voltage cables connection	max 2.5 mm ²
Connection for internal grounding point	max 2.5 mm ²
Connection for external equipotential grounding point	max 6 mm ²

Cables for wiring must be non-armoured cables, with external covering sheath and must be suitable for use in environments with temperatures from - 20 °C to +110 °C (for valves either with N or V seals) or from - 40 °C to +110 °C (for valves with NL seals).

Cable glands (which must be ordered separately, see paragraph 9) allow to use cables with external diameter between 8 and 10 mm.

4.2 - Electrical diagram

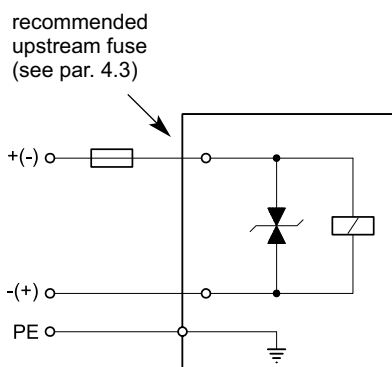

4.3 - Overcurrent fuse and switch-off voltage peak

Upstream of each valve, an appropriate fuse (max 3 x I_n according to IEC 60127) or a protective motor switch with short-circuit and thermal instantaneous tripping, as short-circuit protection, must be connected. The cut-off power of the fuse must correspond or exceed the short circuit current of the supply source.

The fuse or the protective motor must be placed outside the dangerous area or they must be protected with an explosion-proof covering.

In order to safeguard the electronic device to which the valve is connected, there is a protection circuit in the coil, that reduces voltage peaks, which can occur when inductances are switched off.

The table shows the type of fuse recommended according to the nominal voltage of the valve and to the value of the voltage peaks reduction.

Coil type	Nominal voltage [V]	Rated current [A]	Recommended pre-fuse characteristics medium time-lag according to DIN 41571 [A]	Maximum voltage value upon switch off [V]	Suppressor circuit
D12	12	1,88	2,5	- 49	Transient voltage suppressor bidirectional
D24	24	0,86	1,25	- 49	

5 - OVERALL AND MOUNTING DIMENSIONS

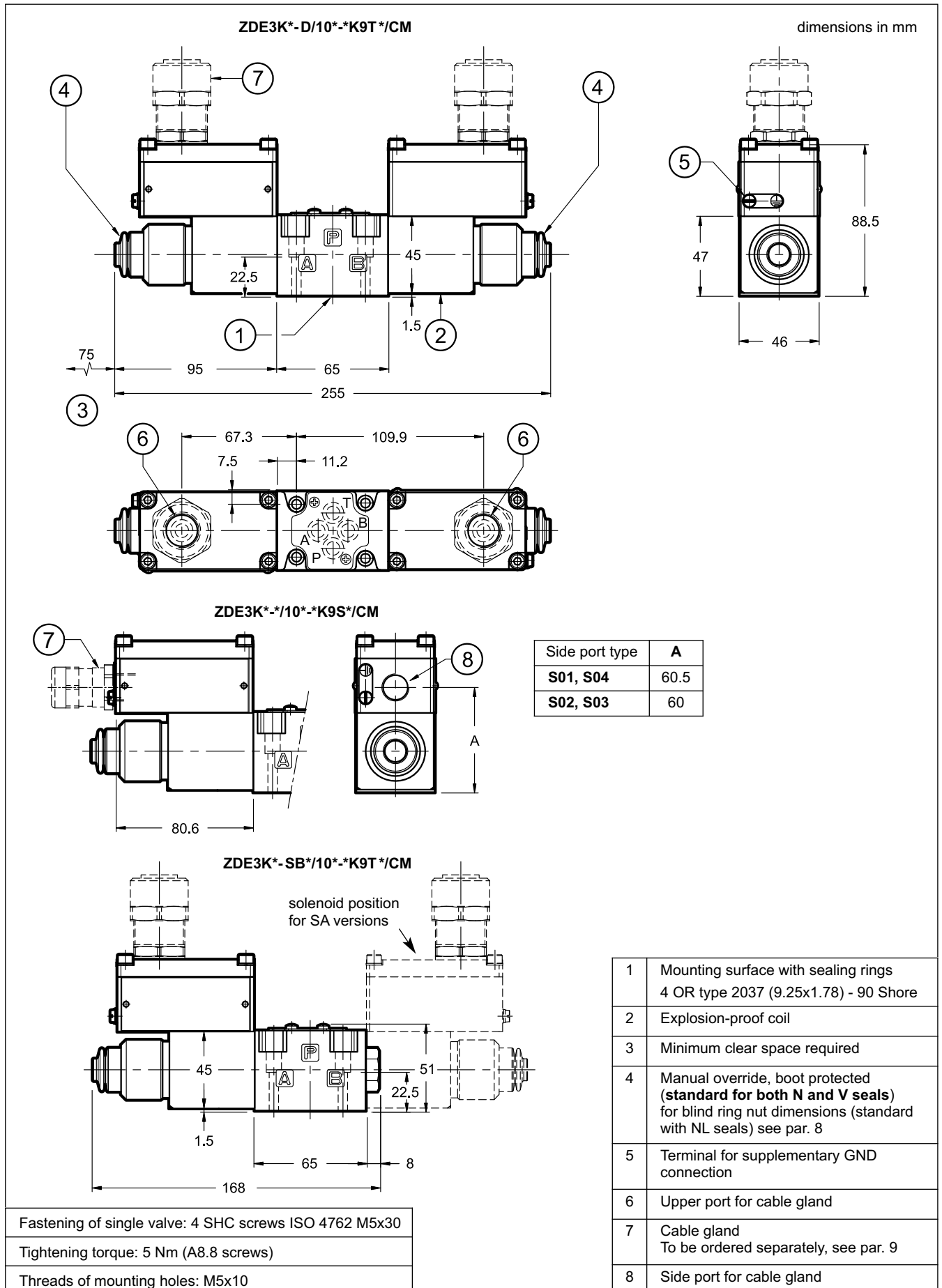



6 - HYDRAULIC FLUIDS

Use mineral oil-based hydraulic fluids HL or HM type, according to ISO 6743-4. For these fluids, use NBR seals. For fluids HFDR type (phosphate esters) use FPM seals (code V). For the use of other fluid types such as HFA, HFB, HFC, please consult our technical department. Using fluids at temperatures higher than 80 °C causes a faster degradation of the fluid and of the seals characteristics. The fluid must be preserved in its physical and chemical characteristics.

7 - INSTALLATION



Installation must adhere to instruction reported in the *Use and Maintenance manual*, always attached to the valve. Unauthorized interventions can be harmful to people and goods because of the explosion hazards present in potentially explosive atmospheres.

The valves can be installed in any position without impairing correct operation.

Ensure that there is no air in the hydraulic circuit.

Connect the valve T port directly to the tank. Add any backpressure value detected in the T line to the reduced pressure value.

In the T line the maximum admissible backpressure is 30 bar, under operational conditions.

Valves are fixed by means of screws or tie rods on a flat surface with planarity and roughness equal to or better than those indicated in the relative symbols. If minimum values are not observed fluid can easily leak between the valve and support surface.

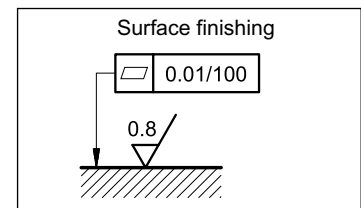

8 - MANUAL OVERRIDE CB

CB - Blind ring nut

The metal ring nut protects the solenoid tube from atmospheric agents and isolates the manual override from accidental operations. The ring nut is tightened on a threaded fastener that keeps the coil in its position even without the ring nut.

To access the manual override loose the ring nut and remove it; then reassemble hand tightening, until it stops.

Activate the manual override always and only with non-sparking tools suitable for use in potentially explosive atmospheres.

More information on safe use of explosion-proof components are provided in the instruction manual, always supplied with the valve.



CAUTION!: The manual override doesn't allow any proportional regulation; indeed using this kind of override, the spool opens the path completely and the whole inlet pressure will pass through A or B line.

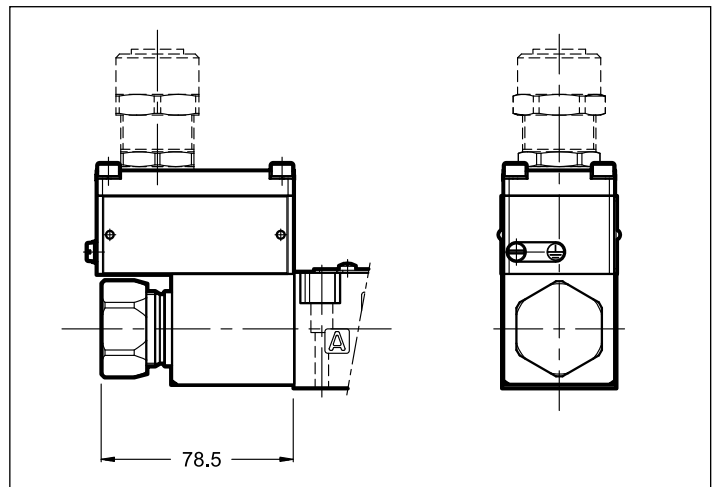

9 - CABLE GLANDS

Cable glands must be ordered separately; Duplomatic offers some types of cable glands with the following features:

- version for non-armoured cable, external seal on the cable (suitable for $\varnothing 8+10$ mm cables);
- ATEX II 2GD, I M2; IECEx Gb, Db, Mb
- cable gland material: nickel brass
- inner rubber tip material: silicone
- ambient temperature range: $-65\text{ }^{\circ}\text{C} + +220\text{ }^{\circ}\text{C}$
- protection degree: IP66/IP68

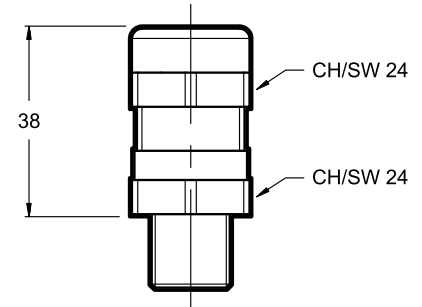

To order the desired cable glands, specify description, code and quantity.

Description: CGK2/NB-01/10

Code: 3908108001

M20x1.5 - ISO 261 male thread, suitable for coils with T01 and S01 connections. It is supplied equipped with copper washer, that must be assembled between the cable gland and the coil, so as to ensure IP66/IP68 protection degree.

Tightening torque: 45 ± 50 Nm

Description: CGK2/NB-02/10

Code: 3908108002

Gk 1/2 - UNI EN 10226-2 male thread, suitable for coils with T02 and S02 connections. The customer must apply LOCTITE® 243™ threadlocker or similar between the cable gland connection thread and the coil in order to ensure IP66/IP68 protection degree.

Tightening torque: 20 ± 25 Nm

Description: CGK2/NB-03/10

Code: 3908108003

1/2" NPT - ANSI B1.20.1 (ex ANSI B2.1), suitable for coils with T03 and S03 connections. The customer must apply LOCTITE® 243™ threadlocker or similar between the cable gland connection thread and the coil in order to ensure IP66/IP68 protection degree.

Tightening torque: 20 ± 25 Nm

Description: CGK2/NB-04/10

Code: 3908108004

M16x1.5 - ISO 261 male thread, suitable for coils with S04 connection. It is supplied equipped with copper washer, that must be assembled between the cable gland and the coil, so as to ensure IP66/IP68 protection degree.

Tightening torque: 45 ± 50 Nm

10 - ELECTRONIC CONTROL UNITS

ZDE3K*-SA* ZDE3K*-SB*

EDM-M111	for solenoid 24V DC	DIN EN 50022 rail mounting	see cat. 89 251
EDM-M142	for solenoid 12V DC		

ZDE3K*-D*

EDM-M211	for solenoid 24V DC	DIN EN 50022 rail mounting	see cat. 89 251
EDM-M242	for solenoid 12V DC		

NOTE: electronic control units offered are not explosion proof certified; therefore, they must be installed outside the classified area.

11 - SUBPLATES

(see catalogue 51 000)

Type PMMD-AI3G with rear ports
Type PMMD-AL3G with side ports
P, T, A, B port threading: 3/8" BSP

NOTE: Subplates (to be ordered separately) do not contain neither aluminium nor magnesium at a rate higher than the value allowed by norms according to ATEX directive for category II 2GD and I M2.

The user will bear to do the complete assessment of the ignition risk that can occur from the relative use in potentially explosive environments.



ZDE3K*

SERIES 10



DIPLOMATIC MS S.p.A.

via M. Re Depaolini 24 • 20015 PARABIAGO (MI) • ITALY
tel. +39 0331.895.111 • www.diplomatic.com • e-mail: sales.exp@diplomatic.com

EXPLOSION-PROOF CLASSIFICATION

for

SOLENOID AND PROPORTIONAL VALVES

ref. catalogues:

pressure control valves

RQM*K*-P	21 515
P*E*K*	81 316
ZDE3K*	81 515
DZCE*K*	81 606

flow control valves

QDE3K*	82 225
---------------	---------------

directional valves

D*K*	41 515
DT3K*	42 215
DS(P)E*K*	83 510

GENERAL INFO

This informative technical datasheet displays information about **classification and marking** of Duplomatic explosion-proof valves range.

Duplomatic MS offers valves with the following certifications:

ATEX	II 2G	II 2D	I M2
IECEX	Gb	Db	Mb
INMETRO	Gb	Db	Mb
PESO	Gb		

Instructions for use and maintenance can be found in the related manuals, always supplied together with valves.



1 - ATEX CLASSIFICATION AND TEMPERATURES

Diplomatic certifies the combination valve-coil for the valves suitable for application and installation in potentially explosive atmospheres, according to ATEX directive; the supply always includes the declaration of conformity to the directive and the operating and maintenance manual, that contains all the information needed for a correct use of the valve in potentially explosive environments.

Coils assembled on these valves have been separately certified according to ATEX directive and so they are suitable for use in potentially explosive atmospheres.

1.1 - ATEX classification for valves

Type examination certificate: AR18ATEX055

The valves are suitable for applications and installations in potentially explosive atmospheres that fall within:

ATEX II 2G ATEX II 2D	*KD2	equipment intended for use in areas in which explosive atmospheres caused by gases, vapours, mists or air/dust mixtures are likely to occur occasionally. The means of protection relating to equipment in this category ensure the requisite level of protection, even in the event of frequently occurring disturbances or equipment faults which normally have to be taken into account.
ATEX I M2	*KDM2	equipment intended for use in underground parts of mines as well as those parts of surface installations of such mines likely to be endangered by firedamp and/or combustible dust. This equipment is intended to be de-energised in the event of an explosive atmosphere.

1.2 - ATEX marking for valves

valve code		N and V seals	NL seals
*KD2	for gas	II 2G IIC T4 Gb (-20°C Ta +80°C)	II 2G IIC T4 Gb (-40°C Ta +80°C)
	for dusts	II 2D IIIC T154°C Db IP66/IP68 (-20°C Ta +80°C)	II 2D IIIC T154°C Db IP66/IP68 (-40°C Ta +80°C)
*KD2 /T5	for gas	II 2G IIC T5 Gb (-20°C Ta +55°C)	II 2G IIC T5 Gb (-40°C Ta +55°C)
	for dusts	II 2D IIIC T129°C Db IP66/IP68 (-20°C Ta +55°C)	II 2D IIIC T129°C Db IP66/IP68 (-40°C Ta +55°C)
*KDM2	mining	I M2 I T150°C Mb IP66/68 (-20°C Ta +75°C)	I M2 I T150°C Mb IP66/68 (-40°C Ta +75°C)

Specific marking as ATEX 2014/34/EU directive and related technical specifications

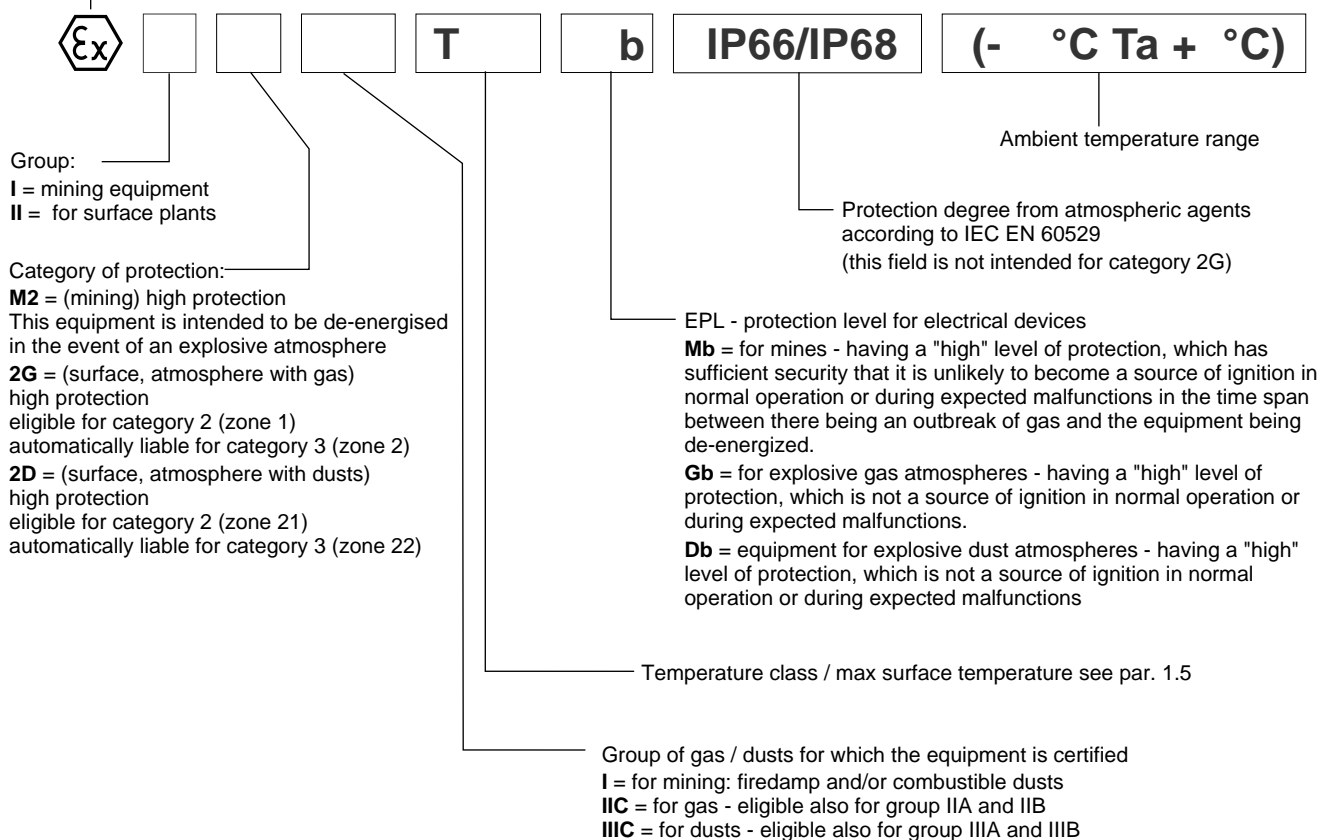



1.3 - ATEX classification of the coils

The coil of the explosion-proof valves is ATEX certified itself and, as such, is identified with its own tag, carries the relative ATEX marking. The mechanical construction of the coil housing is made in order to ensure its resistance to possible internal explosion and to avoid any explosion propagation to the outside environment, matching an "Ex db" type protection (explosion-proof coil).

Moreover, the solenoid is designed to maintain its surface temperature below the limits specified to the relevant class.

1.4 - ATEX marking on coils

for valve type *KD2	for gas	II 2G Ex db IIC T4 Gb (-40°C Ta +80°C)
	for dusts	II 2D Ex tb IIIC T154°C Db IP66/IP68 (-40°C Ta +80°C)
for valve type *KD2 /T5	for gas	II 2G Ex db IIC T5 Gb (-40°C Ta +55°C)
	for dusts	II 2D Ex tb IIIC T129°C Db IP66/IP68 (-40°C Ta +55°C)
for valve type *KDM2	mining	I M2 Ex db I T150°C Mb IP66/IP68 (-40°C Ta +75°C)

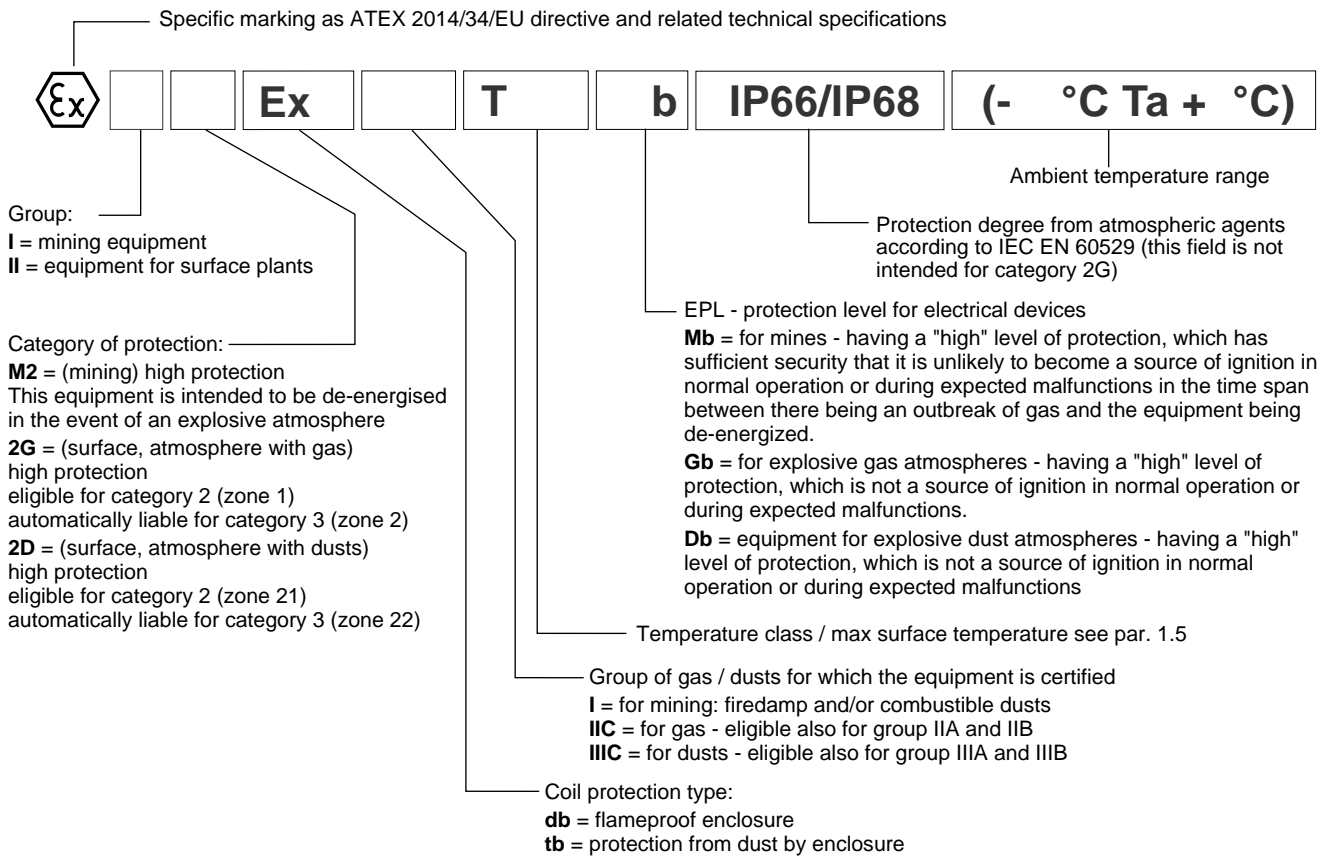

1.5 - Operating temperatures

These valves are classified according to their maximum surface temperature (EN 13463-1), which must be lower than the ignition temperature of the gases, vapors and dusts for which the area in which they will be used is classified.

The valves in group II can also be used for less limiting temperature classes (surface temperature allowed higher).

		temperature range	N and V seals	NL seals	Temperature class	eligible also for
ATEX II 2G ATEX II 2D	*KD2	of ambient	-20 / +80 °C	-40 / +80 °C	T4 (gas)	T3, T2, T1
		of fluid			T154°C (dusts)	T200°C and higher
	*KD2 /T5	of ambient	-20 / +55 °C	-40 / +55 °C	T5 (gas)	T4, T3, T2, T1
		of fluid	-20 / +60 °C	-40 / +60 °C	T129°C (dusts)	T135°C and higher
ATEX I M2	*KDM2	of ambient	-20 / +75 °C	-40 / +75 °C	T150°C	-
		of fluid				



2 - IECEX CLASSIFICATION AND TEMPERATURES

The IECEX certification requires the classification of the electrical equipment only.

Diplomatic supplies valves with IECEX certified coils, suitable for application and installation in potentially explosive atmospheres. The mechanical construction of the coil housing is made in order to ensure its resistance to possible internal explosion and to avoid any explosion propagation to the outside environment, matching an "Ex db" type protection (explosion-proof coil).

Moreover, the solenoid is designed to maintain its surface temperature below the limits specified to the relevant class.

The supply always includes the operating and maintenance manual, that contains all the information needed for a correct use of the valve in potentially explosive environment.

2.1 - IECEX classification

Certificate of conformity (CoC): IECEX TUN 15.0028X

The valves are suitable for applications and installations in potentially explosive atmospheres that fall within:

IECEX Gb IECEX Db	*KXD2	equipment intended for use in areas in which explosive atmospheres caused by gases, vapours, mists or air/dust mixtures are likely to occur occasionally. The means of protection relating to equipment in this category ensure the requisite level of protection, even in the event of frequently occurring disturbances or equipment faults which normally have to be taken into account.
IECEX Mb	*KXDM2	equipment intended for use in underground parts of mines as well as those parts of surface installations of such mines likely to be endangered by firedamp and/or combustible dust. This equipment is intended to be de-energised in the event of an explosive atmosphere.

2.2 - IECEX marking

There is a plate with the IECEX mark on each coil.

*KXD2 valves	for gas	Ex db IIC T4 Gb (-40°C Ta +80°C)
	for dusts	Ex tb IIIC T135°C Db (-40°C Ta +80°C)
*KXD2 /T5 valves	for gas	Ex db IIC T5 Gb (-40°C Ta +55°C)
	for dusts	Ex tb IIIC T100°C Db (-40°C Ta +55°C)
*KDM2 valves	mining	Ex db I Mb (-40°C Ta +80°C)

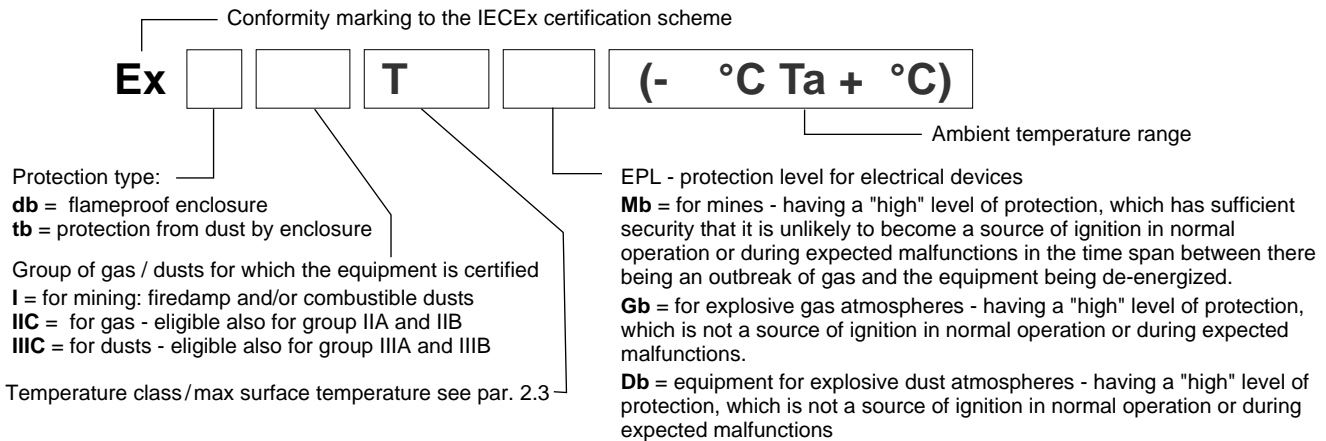

2.3 - Operating temperatures

These valves are classified according to their maximum surface temperature (EN 13463-1), which must be lower than the ignition temperature of the gases, vapors and dusts for which the area in which they will be used is classified.

Valves for surface plants can also be used for less limiting temperature classes (higher surface temperature allowed).

		temperature range	N and V seals	NL seals	Temperature class	eligible also for
IECEX Gb IECEX Db	*KXD2	of ambient	-20 / +80 °C	-40 / +80 °C	T4 (gas) T135°C (dusts)	T3, T2, T1 T200°C and higher
		of fluid				
IECEX Gb IECEX Db	*KXD2 /T5	of ambient	-20 / +55 °C	-40 / +55 °C	T5 (gas) T100°C (dusts)	T4, T3, T2, T1 T135°C and higher
		of fluid				
IECEX Mb	*KXDM2	of ambient	-20 / +80 °C	-40 / +80 °C	-	-
		of fluid				

2.4 - Protection degree from atmospheric agents (IEC EN 60529)

Protection degree from atmospheric agents according to IEC EN 60529 is IP66/IP68.



3 - INMETRO CLASSIFICATION AND TEMPERATURES

The INMETRO certification requires the classification of the electrical equipment only.

Diplomatic supplies valves with INMETRO certified coils, suitable for application and installation in potentially explosive atmospheres. The mechanical construction of the coil housing is made in order to ensure its resistance to possible internal explosion and to avoid any explosion propagation to the outside environment, matching an "Ex db" type protection (explosion-proof coil).

Moreover, the solenoid is designed to maintain its surface temperature below the limits specified to the relevant class.

The supply always includes the operating and maintenance manual, that contains all the information needed for a correct use of the valve in potentially explosive environment.

3.1 - INMETRO classification

Certificate of conformity: TÜV 19.1844 X

The valves are suitable for applications and installations in potentially explosive atmospheres that fall within:

INMETRO Gb INMETRO Db	*KBD2	equipment intended for use in areas in which explosive atmospheres caused by gases, vapours, mists or air/dust mixtures are likely to occur occasionally. The means of protection relating to equipment in this category ensure the requisite level of protection, even in the event of frequently occurring disturbances or equipment faults which normally have to be taken into account.
INMETRO Mb	*KBDM2	equipment intended for use in underground parts of mines as well as those parts of surface installations of such mines likely to be endangered by firedamp and/or combustible dust. This equipment is intended to be de-energised in the event of an explosive atmosphere.

3.2 - INMETRO marking

There is a plate with the INMETRO mark on each coil.

*KBD2 valves	for gas	Ex db IIC T4 Gb (-40°C Ta +80°C)
	for dusts	Ex tb IIIC T154°C Db IP66/IP68 (-40°C Ta +80°C)
*KBD2 /T5 valves	for gas	Ex db IIC T5 Gb (-40°C Ta +55°C)
	for dusts	Ex tb IIIC T129°C Db IP66/IP68 (-40°C Ta +55°C)
*KBDM2 valves	mining	Ex db I T150° Mb IP66/IP68 (-40°C Ta +75°C)

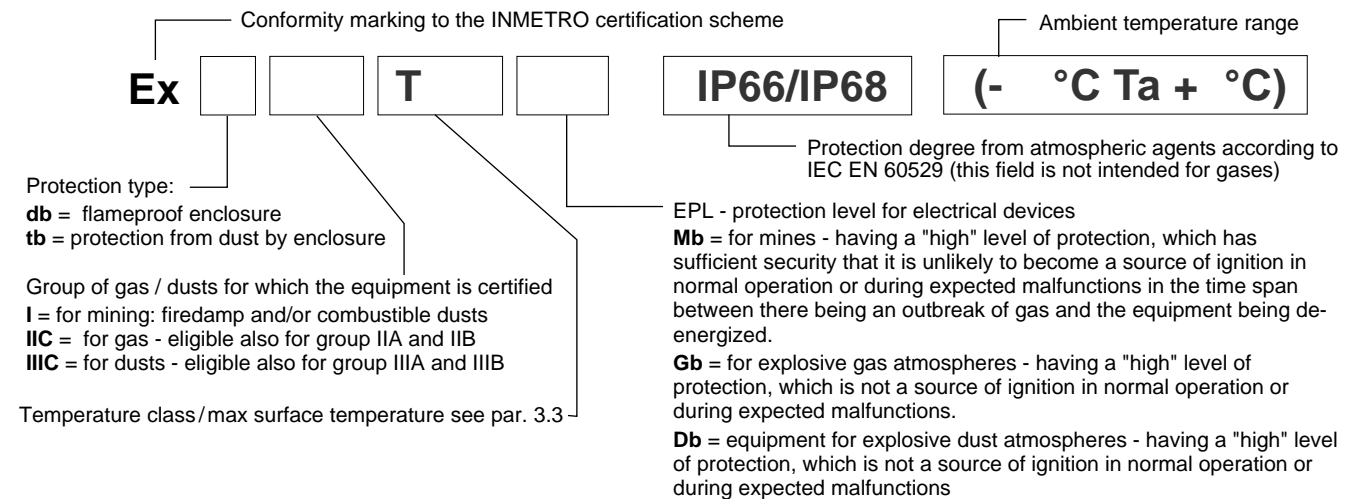

3.3 - Operating temperatures

These valves are classified according to their maximum surface temperature (EN 13463-1), which must be lower than the ignition temperature of the gases, vapors and dusts for which the area in which they will be used is classified.

Valves for surface plants can also be used for less limiting temperature classes (higher surface temperature allowed).

		temperature range	N and V seals	NL seals	Temperature class	eligible also for
INMETRO Gb INMETRO Db	*KBD2	of ambient	-20 / +80 °C	-40 / +80 °C	T4 (gas)	T3, T2, T1
		of fluid			T154°C (dusts)	T200°C and higher
INMETRO Db	*KBD2 /T5	of ambient	-20 / +55 °C	-40 / +55 °C	T5 (gas)	T4, T3, T2, T1
		of fluid			T129°C (dusts)	T135°C and higher
INMETRO Mb	*KBDM2	of ambient	-20 / +75 °C	-40 / +75 °C	T150°C	-
		of fluid				



BIBUS SK, s.r.o
Trnavská 31, SK-94 901 Nitra

Tel.: 037/ 7777 911 Email: sale@bibus.sk
Fax.: 037/ 7777 999 http://www.bibus.sk

4 - PESO CLASSIFICATION AND TEMPERATURES

The PESO certification requires the classification of the electrical equipment only.

Diplomatic supplies valves with PESO certified coils, suitable for application and installation in potentially explosive atmospheres. The mechanical construction of the coil housing is made in order to ensure its resistance to possible internal explosion and to avoid any explosion propagation to the outside environment, matching an "Ex db" type protection (explosion-proof coil).

Moreover, the solenoid is designed to maintain its surface temperature below the limits specified to the relevant class.

The supply always includes the operating and maintenance manual, that contains all the information needed for a correct use of the valve in potentially explosive environment.

4.1 - PESO classification

Certificate of conformity: P480801

The valves are suitable for applications and installations in potentially explosive atmospheres that fall within:

PESO Gb	*KPD2	equipment intended for use in areas in which explosive atmospheres caused by gases, vapours, mists are likely to occur occasionally. The means of protection relating to equipment in this category ensure the requisite level of protection, even in the event of frequently occurring disturbances or equipment faults which normally have to be taken into account.
---------	-------	--

4.2 - PESO marking

There is a plate with the PESO mark on each coil.

*KPD2 valves	for gas	Ex db IIC T4 Gb (-40°C Ta +80°C)
*KPD2 /T5 valves	for gas	Ex db IIC T5 Gb (-40°C Ta +55°C)

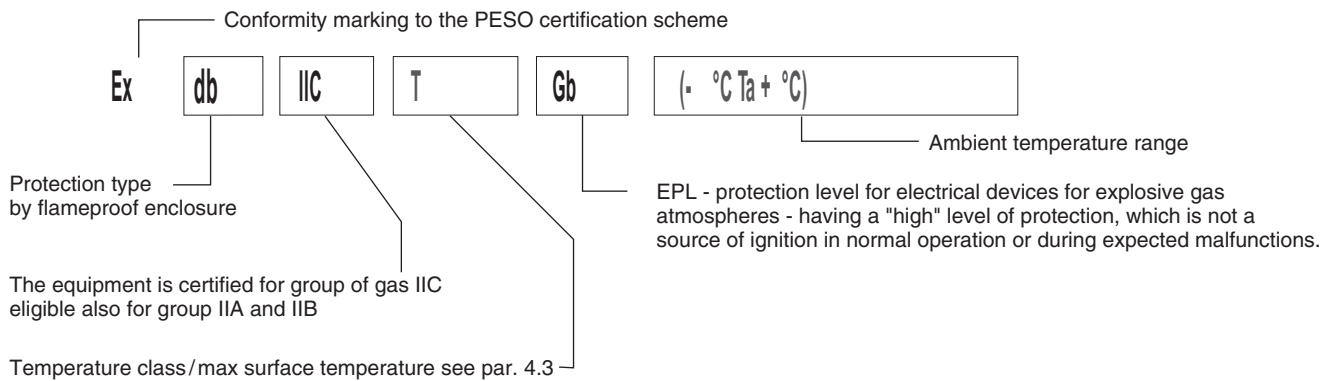

4.3 - Operating temperatures

These valves are classified according to their maximum surface temperature (EN 13463-1), which must be lower than the ignition temperature of the gases, vapors and dusts for which the area in which they will be used is classified.

Valves for surface plants can also be used for less limiting temperature classes (higher surface temperature allowed).

		temperature range	N and V seals	NL seals	Temperature class	eligible also for
PESO Gb	*KPD2	of ambient	-20 / +80 °C	-40 / +80 °C	T4 (gas)	T3, T2, T1
		of fluid				
	*KPD2 /T5	of ambient	-20 / +55 °C	-40 / +55 °C	T5 (gas)	T4, T3, T2, T1
		of fluid				

4.4 - Protection degree from atmospheric agents (IEC EN 60529)

Protection degree from atmospheric agents according to IEC EN 60529 is IP66/IP68.



DIPLOMATIC MS Spa

via Mario Re Depaolini, 24 | 20015 Parabiago (MI) | Italy
T +39 0331 895111 | E vendite.ita@duplomatic.com | sales.exp@duplomatic.com
duplomaticmotionsolutions.com