



M*F3(M)

SHUT-OFF VALVES

SOLENOID OR HYDRAULICALLY ACTUATED, WITH OR WITHOUT POSITION MONITORING

SERIES 10

MODULAR VERSION
ISO 4401-03

p max 350 bar
Q max 50 l/min

MOUNTING INTERFACE

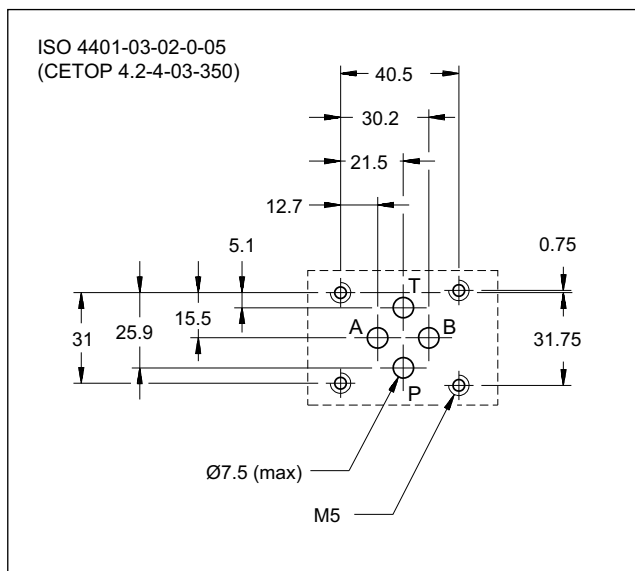

OPERATING PRINCIPLE

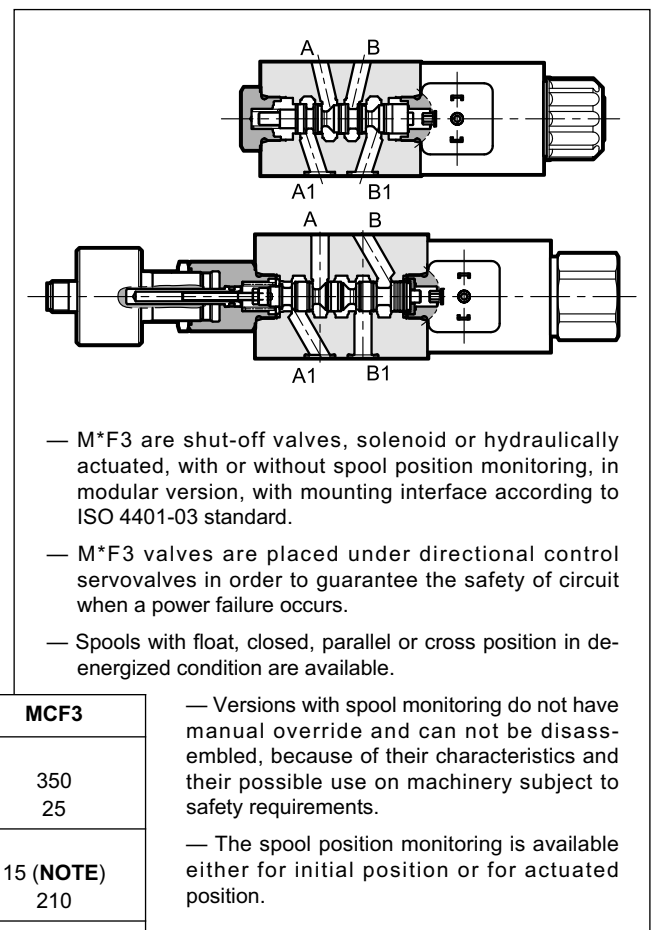

PERFORMANCE RATINGS

(working with mineral oil of viscosity of 36 cSt at 50°C)

		MDF3	MCF3
Maximum operating pressure: P - A - B ports T port	bar	350 210	350 25
Pilot pressure: min max	bar	-	15 (NOTE) 210
Maximum flow rate	l/min	50	40
Ambient temperature range	°C	-20 / +50	
Fluid temperature range	°C	-20 / +80	
Fluid viscosity range	cSt	10 ÷ 400	
Fluid contamination degree	According to ISO 4406:1999 class 20/18/15		
Recommended viscosity	cSt	25	
Mass	kg	1,5	1,3

NOTE: The pilot pressure must be 10 to 20 bar higher than the return pressure to allow the fluid discharge from the pressure chamber.

1 - IDENTIFICATION CODES

1.1 - M*F3 valves

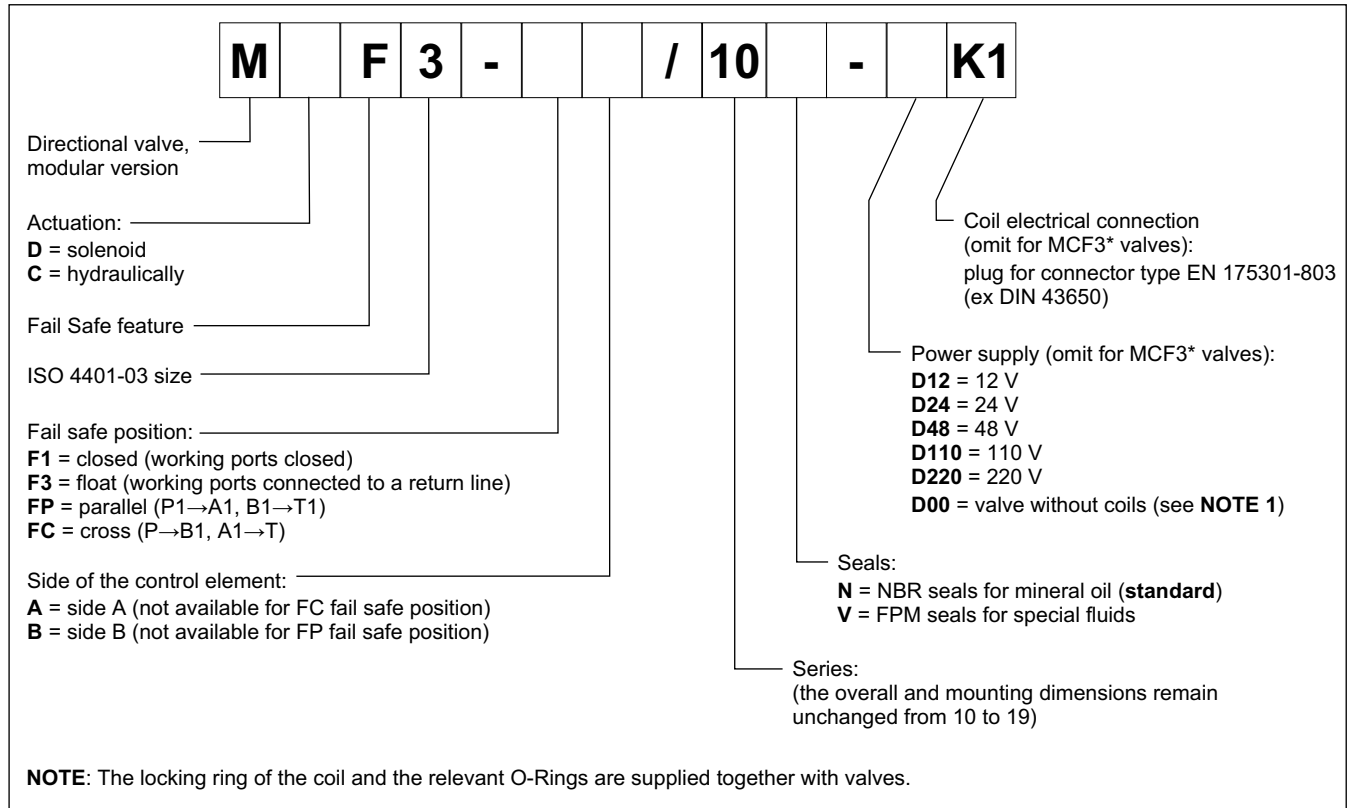

1.2 - M*F3M valves with monitored spools

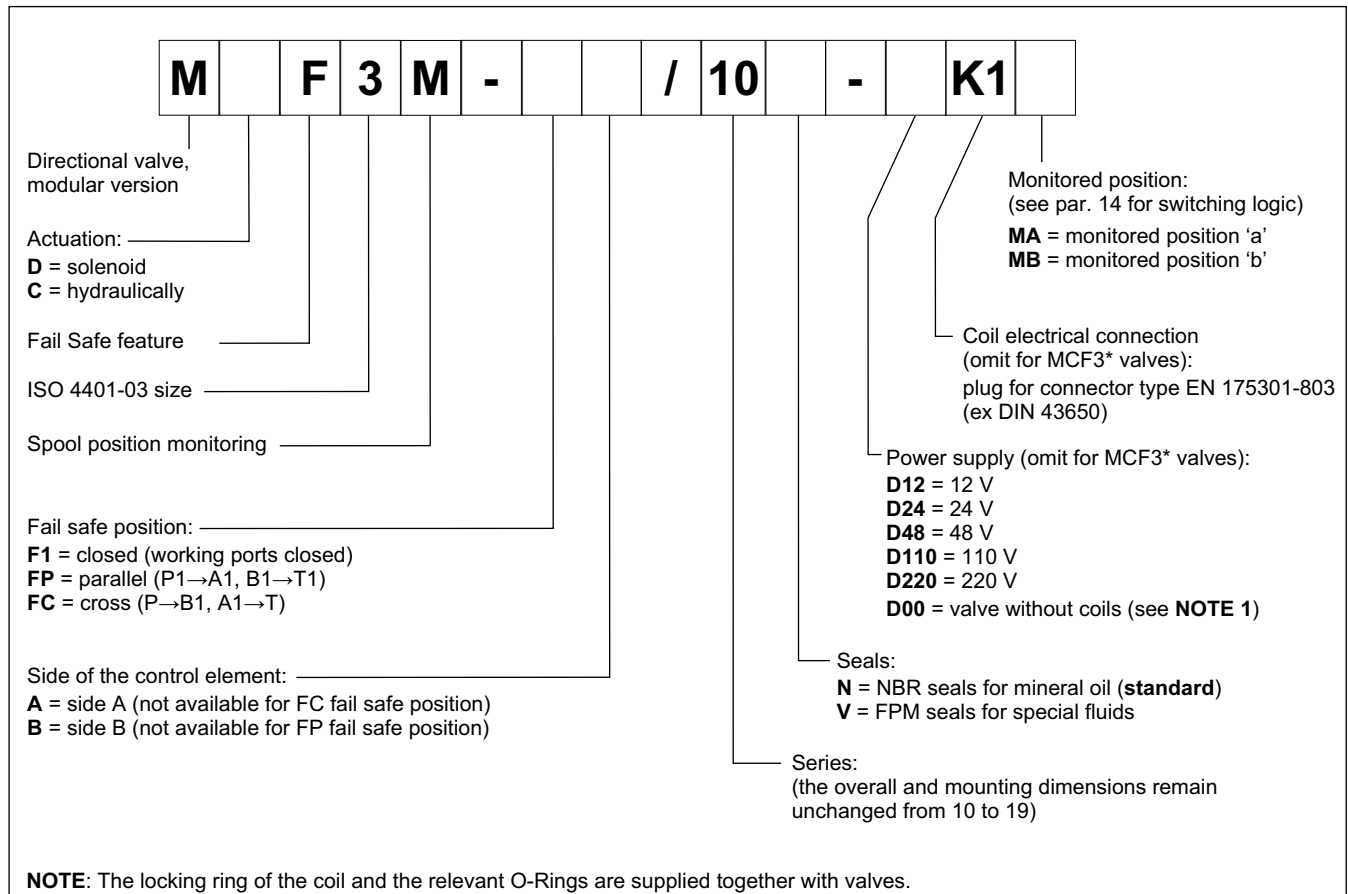

2 - HYDRAULIC FLUIDS

Use mineral oil-based hydraulic fluids HL or HM type, according to ISO 6743-4. For these fluids, use NBR seals (code N). For fluids HFDR type (phosphate esters) use FPM seals (code V). For the use of other fluid types such as HFA, HFB, HFC, please consult our technical department.

Using fluids at temperatures higher than 80 °C causes a faster degradation of the fluid and of the seals characteristics. The fluid must be preserved in its physical and chemical characteristics.

3 - HYDRAULIC SYMBOLS

3.1 - MDF3 valves

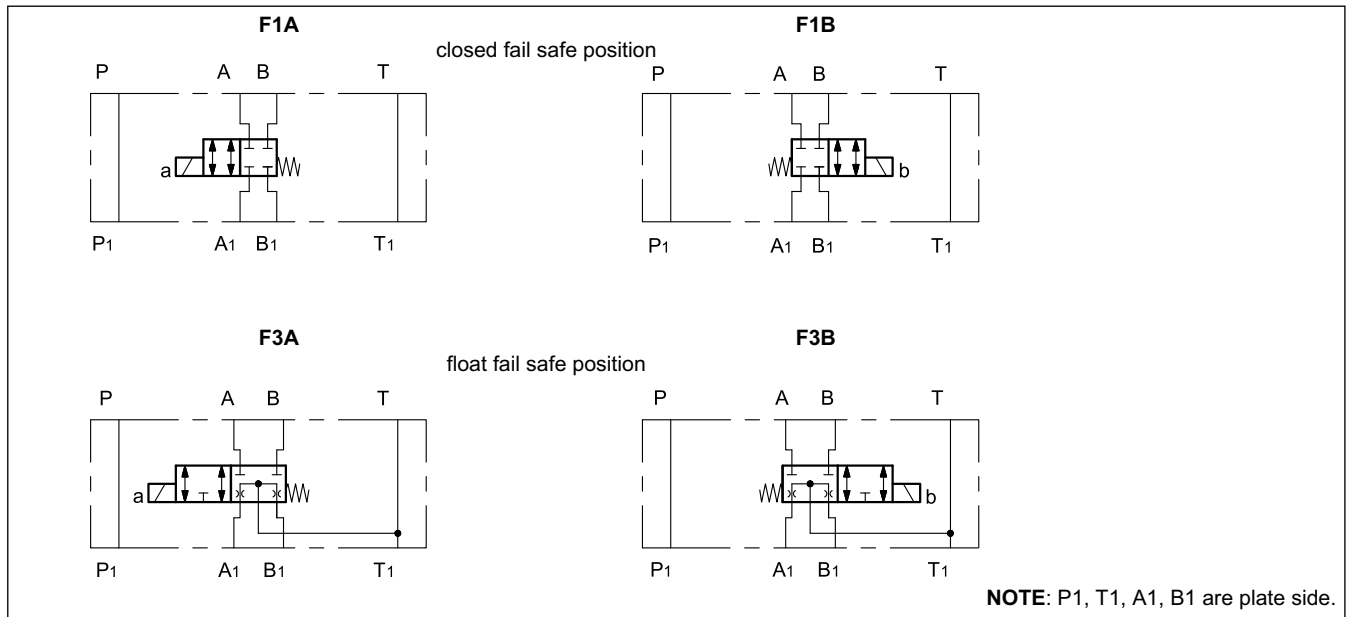

3.2 - MCF3 valves

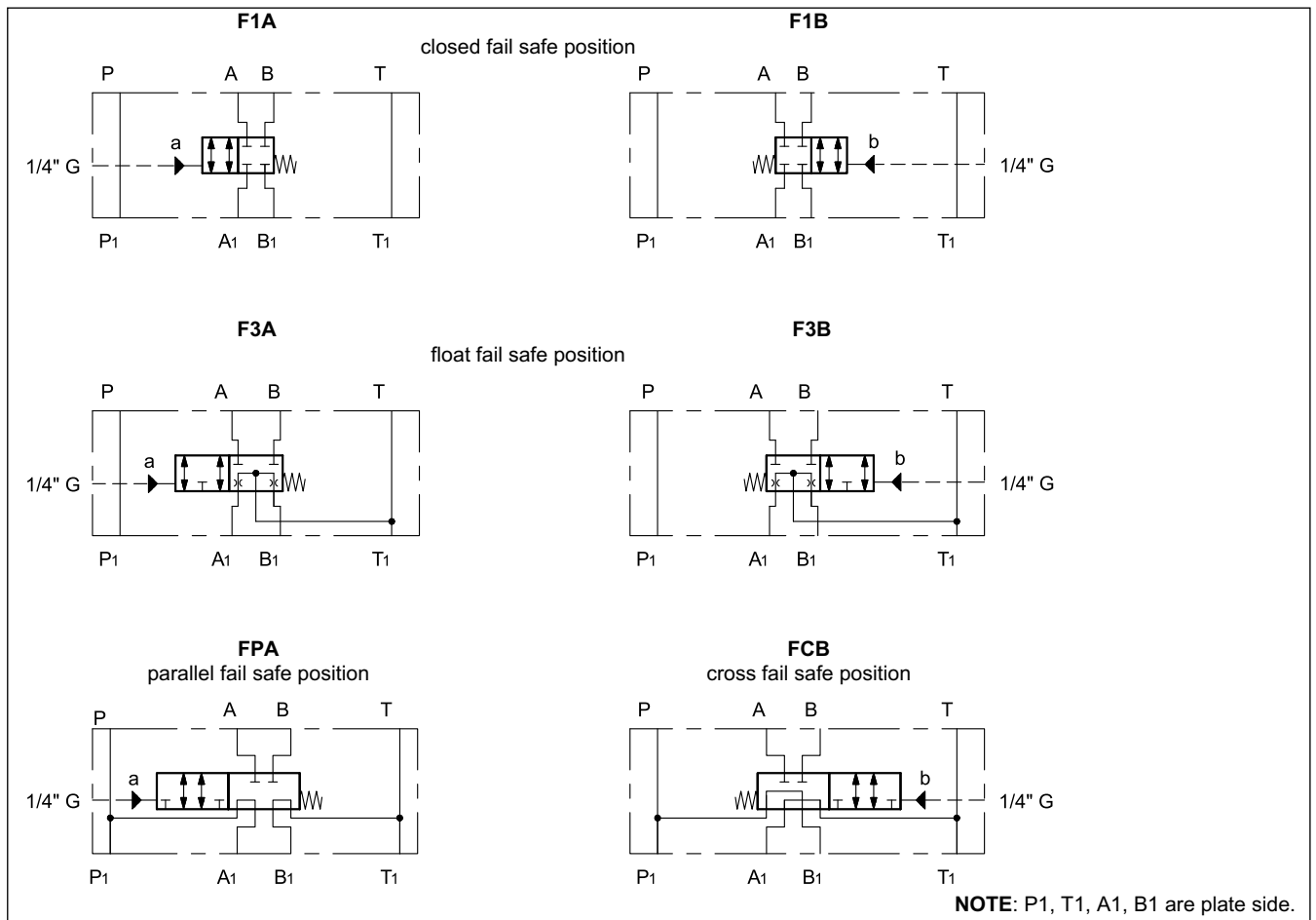

3.3 - MDF3M valves with monitored spools

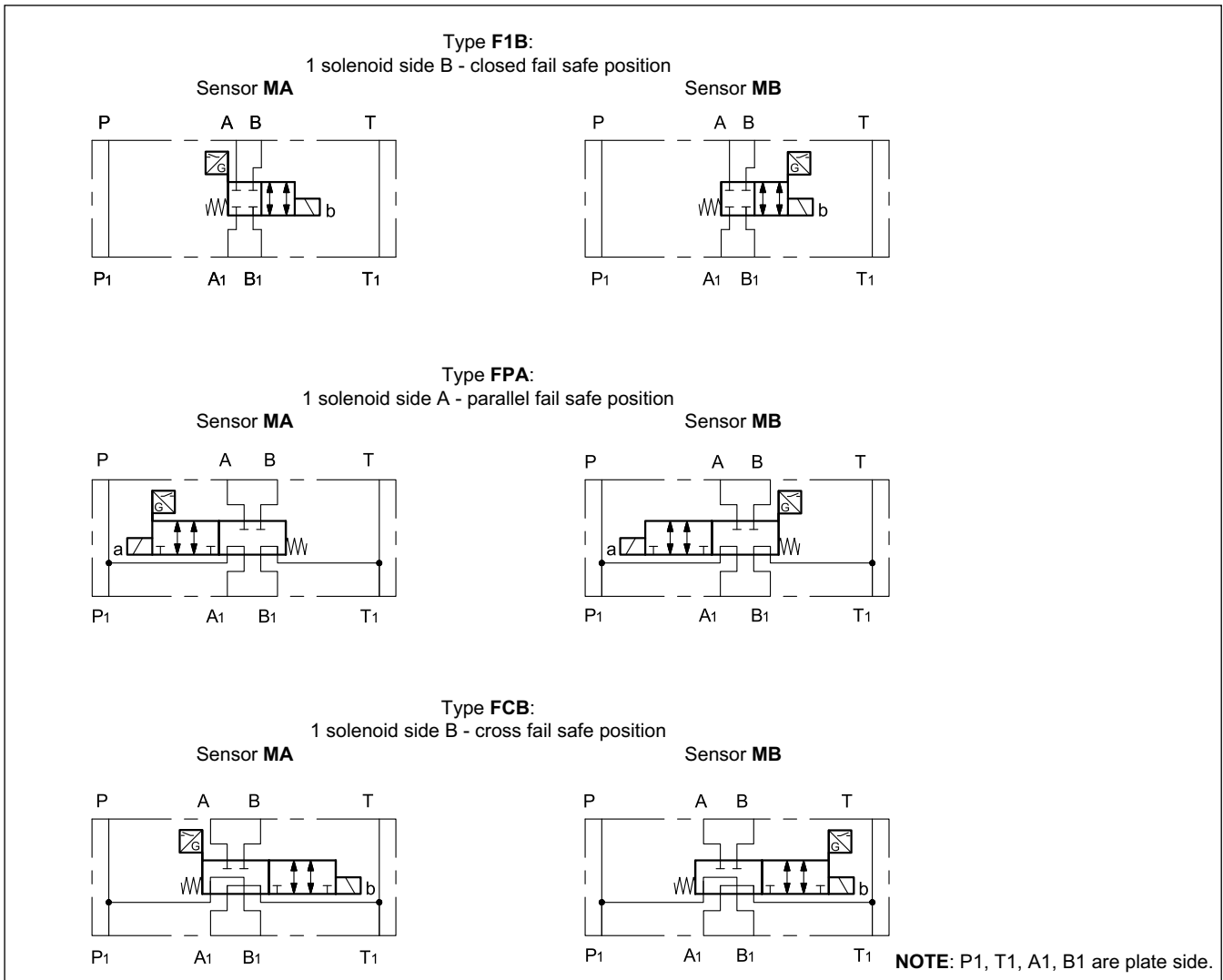

3.4 - MCF3M valves

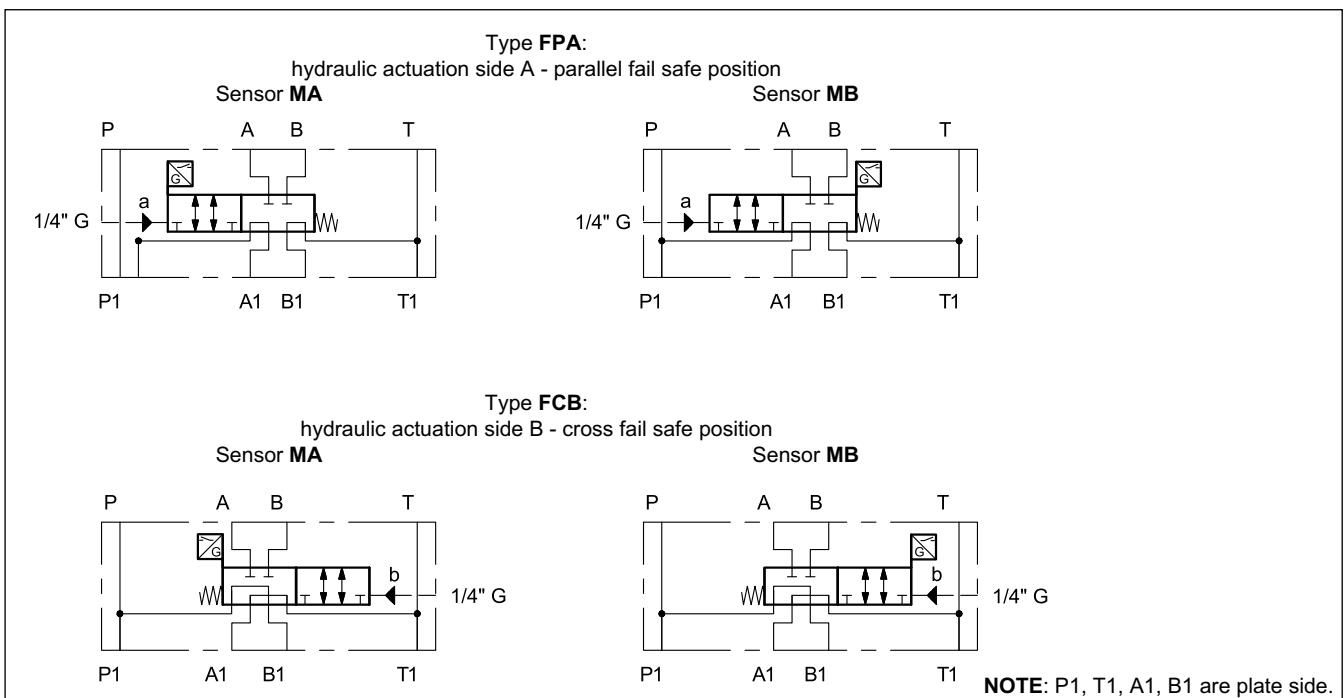

4 - PRESSURE DROPS Δp -Q

(obtained with viscosity 36 cSt at 50 °C)

MD*3-F1*, MD*3-F3*

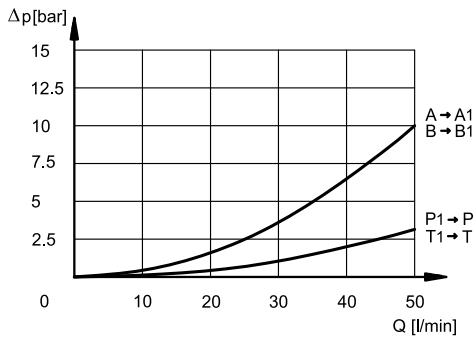

M*F3-FCB

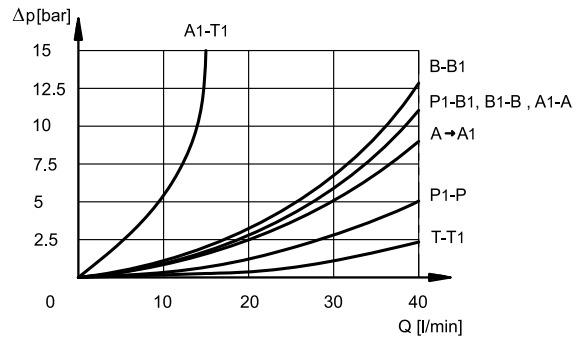

5 - OPERATING LIMITS

The values have been obtained according to ISO 6403 norm with solenoids at rated temperature and supplied with voltage equal to 90% of the nominal voltage. The values have been obtained with mineral oil, viscosity 36 cSt, temperature 50 °C and filtration according to ISO 4406:1999 class 18/16/13.

MDF3-*

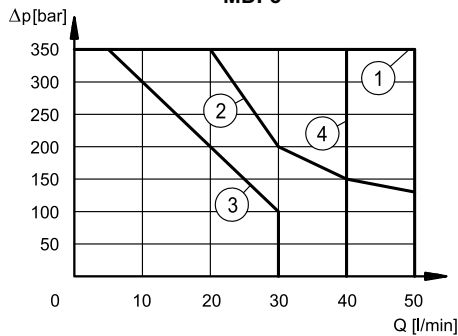

SPOOL TYPE	De-energizing	Energizing	
		with flow in A and B	without flow in A and B
CURVES ON GRAPH			
F1*, F3*	1	2	1
FCB	4	3	3

MCF3-*

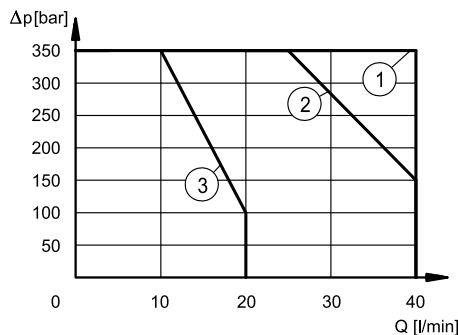

SPOOL TYPE	De-actuating	Actuating	
		pilot pressure tank +10 bar	pilot pressure tank +20 bar
CURVES ON GRAPH			
FCB	1	3	2

6 - SWITCHING TIMES

The values indicated are obtained according to ISO 6403 standard, with mineral oil viscosity 36 cSt at 50°C.

TIMES [ms]	ENERGIZING	DE-ENERGIZING
MDF3 - F1	60 + 90	20 + 50 ms

7 - MDF3 - ELECTRICAL FEATURES

7.1 - Solenoids

These are essentially made up of two parts: tube and coil. The tube is threaded into the valve body and includes the armature that moves immersed in oil, without wear. The inner part, in contact with the oil in the return line, ensures heat dissipation.

The coil is fastened to the tube by a threaded ring; versions without the spool monitoring and can be rotated, to suit the available space.

NOTE 1: In order to further reduce the emissions, use of type H connectors is recommended. These prevent voltage peaks on opening of the coil supply electrical circuit (see cat. 49 000).

NOTE 2: The IP65 protection degree is guaranteed only with the connector correctly connected and installed.

VOLTAGE SUPPLY FLUCTUATION	± 10% Vnom
MAX SWITCH ON FREQUENCY	18.000 ins/hr
DUTY CYCLE	100%
ELECTROMAGNETIC COMPATIBILITY (EMC) (NOTE 1)	In compliance with 2014/30/EU
LOW VOLTAGE	In compliance with 2014/35/EU
CLASS OF PROTECTION Atmospheric agents (IEC 60529) Coil insulation (VDE 0580) Impregnation	IP65 (NOTE 2) class H class F

7.2 - Current and absorbed power

The table shows current and power consumption values relevant to the different coil types for DC.

Using connectors type "D" (see cat. 49 000) with embedded bridge rectifier it is possible to feed DC coils (starting from 48V voltage) with alternating current (50 or 60 Hz), considering a reduction of the operating limits of about 5-10%.

Coils for direct current (values ± 10%)

	Nominal voltage [V]	Resistance at 20°C [Ω]	Current consumpt. [A]	Power consumpt [W]	Coil code
D12	12	4,4	2,72	32,7	1903080
D24	24	18,6	1,29	31	1903081
D48	48	78,6	0,61	29,5	1903083
D110	110	423	0,26	28,2	1903464
D220	220	1692	0,13	28,2	1903465

8 - ELECTRIC CONNECTORS

Solenoid operated valves are delivered without connectors. Connectors can be ordered separately. See catalogue 49 000.

9 - MDF3 OVERALL AND MOUNTING DIMENSIONS

MDF3-F1*
MDF3-F3*

dimensions in mm

1	Mounting surface with sealing rings: 4 OR type 2037 (9.25x1.78) - 90 Shore
2	Standard manual override included in the solenoid tube
3	Coil 360° revolving
4	Coil removal space
5	EN 175301-803 (ex DIN 43650) electrical connector to be ordered separately (see cat. 49 000)
6	Connector removal space

10 - MCF3 OVERALL AND MOUNTING DIMENSIONS

dimensions in mm

MCF3-F1*
MCF3-F3*

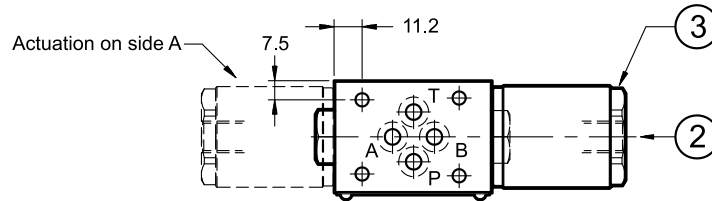
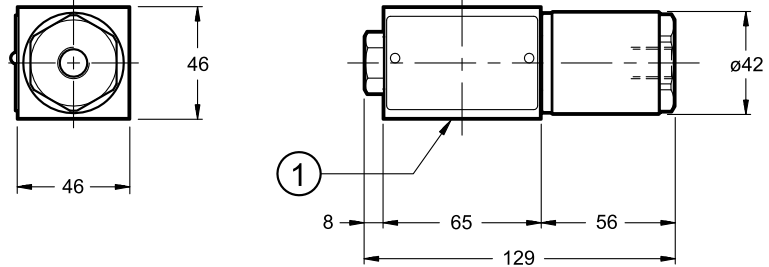

MCF3-FPA

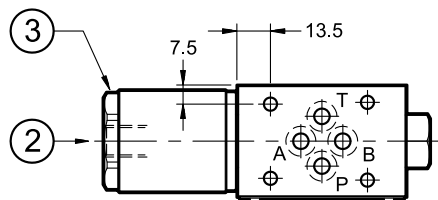
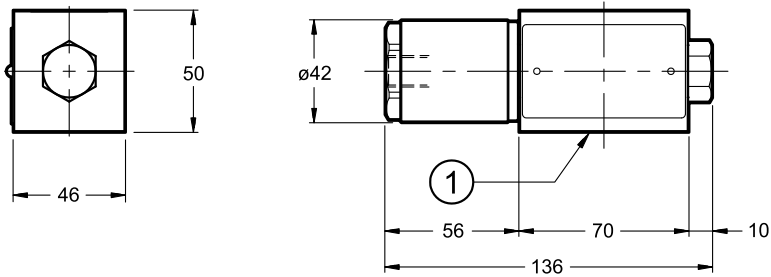

MCF3-FCB

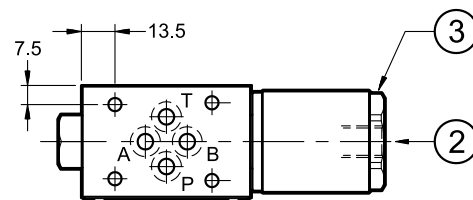
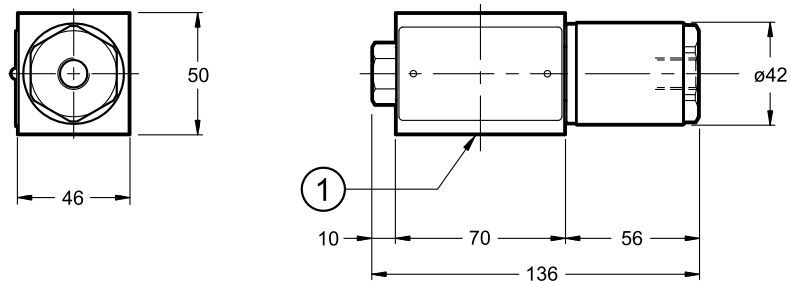

1	Mounting surface with sealing rings: 4 OR type 2037 (9.25x1.78) - 90 Shore
2	1/4" BSP connection for hydraulic actuation
3	Hexagon: spanner 38 Tightening torque 35 ± 40 Nm

11 - MDF3M OVERALL AND MOUNTING DIMENSIONS

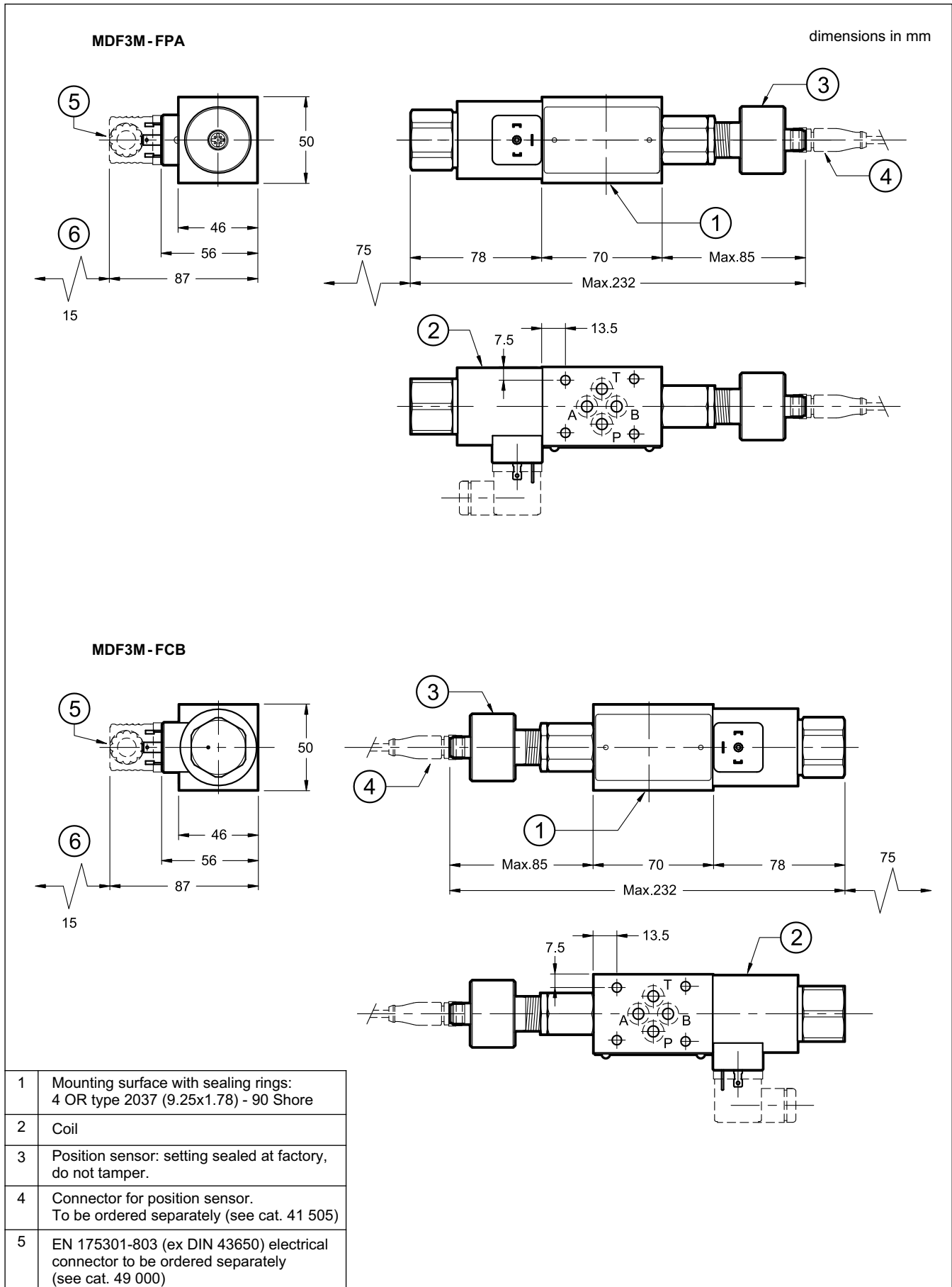

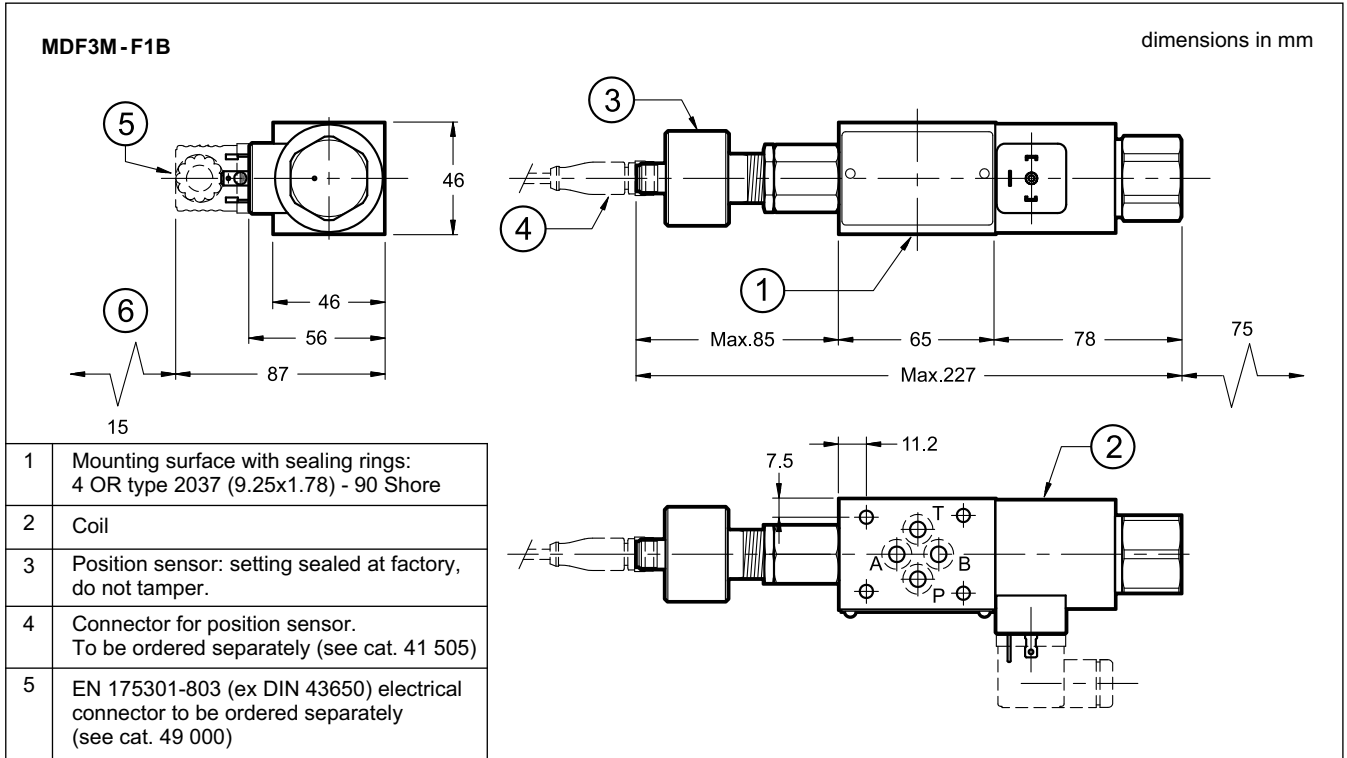

12 - MCF3M OVERALL AND MOUNTING DIMENSIONS

MCF3M-FPA

dimensions in mm

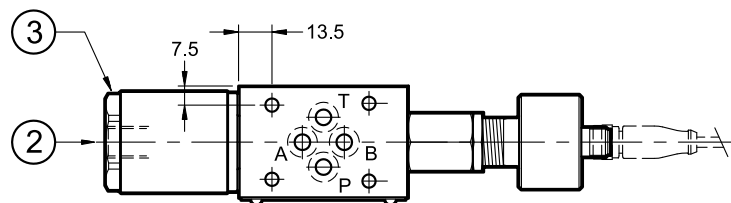
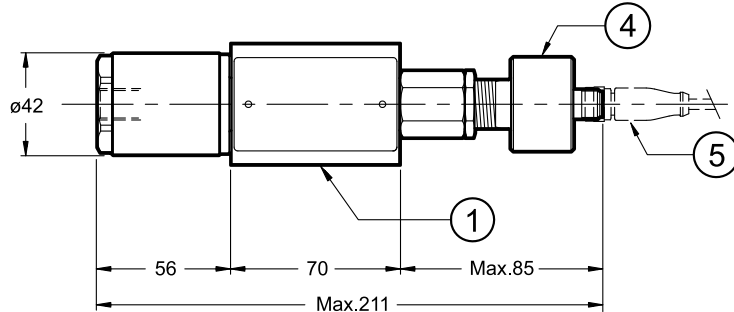
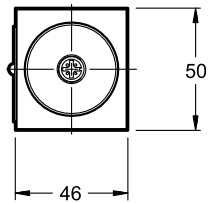

MCF3M-FCB

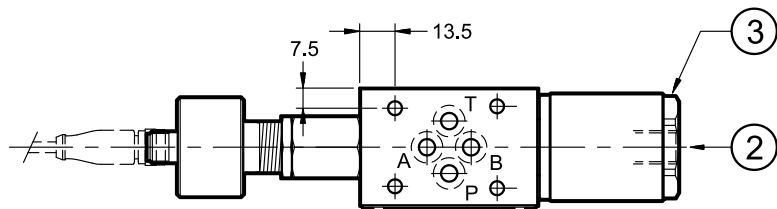
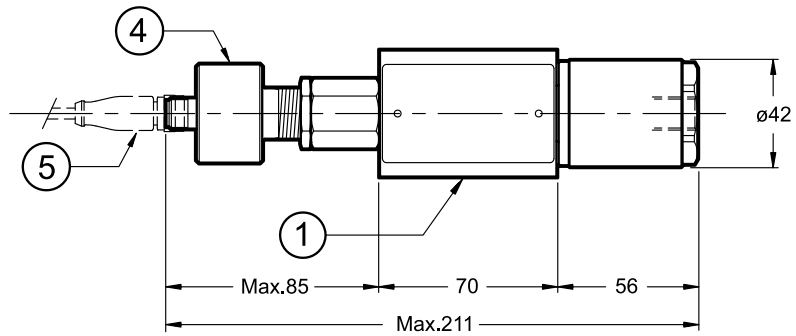
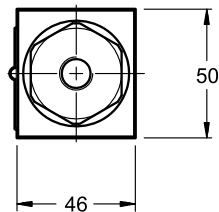

1	Mounting surface with sealing rings: 4 OR type 2037 (9.25x1.78) - 90 Shore
2	1/4" BSP connection for hydraulic actuation
3	Position sensor: setting sealed at factory, do not tamper.
4	Connector for position sensor. To be ordered separately (see cat. 41 505)
5	EN 175301-803 (ex DIN 43650) electrical connector to be ordered separately (see cat. 49 000)

13 - M*F3M POSITION SENSOR



WARNING ! Valve disassembling is not allowed. Sensors must not be unscrewed or tampered.

CONNECTION SCHEME

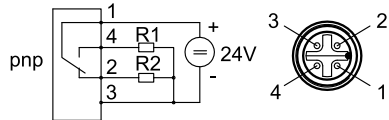

Pin	Values	Function
1	+24 V	Supply
2	NC	Normal Closed
3	0 V	-
4	NO	Normal Open

Operating voltage range	V DC	20 ÷ 32
Absorbed current	A	0.4
Max output load	mA	400
Output		2 PNP
Electric protections		polarity inversion short circuit
Hysteresis	mm	≤ 0.1
Operating temperature range	°C	-25 / +80
Class of protection from atmospheric agents (IEC 60529)		IP65
EMC Electromagnetic compatibility		In compliance with 2014/30/EU

14 - SWITCHING LOGICS

14.1 - MA monitoring

Energized position monitored.

for M*F3M-*F*A valves

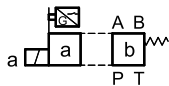
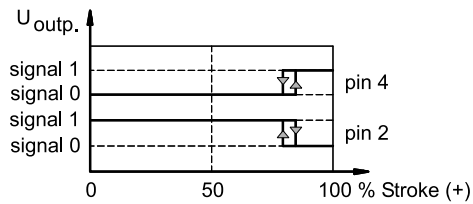

De-energized position monitored.

for M*F3M-*F*B valves

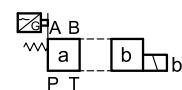
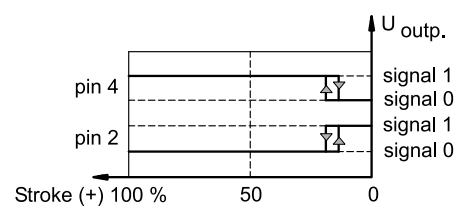

14.2 - MB monitoring

De-energized position monitored.

for M*F3M-*A valves

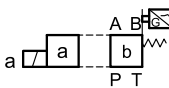
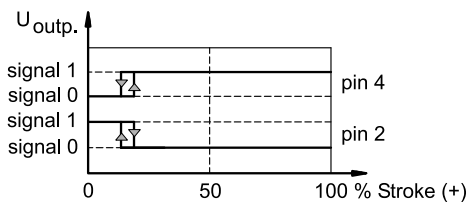

Energized position monitored.

for M*F3M-*B valves

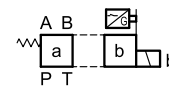
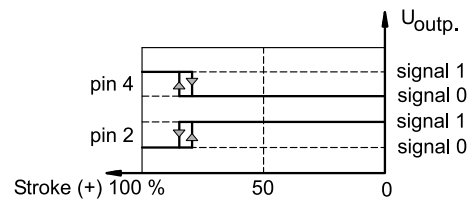



M*F3
SERIES 10

BIBUS[®]
SUPPORTING YOUR SUCCESS

BIBUS SK, s.r.o
Trnavská 31, SK-94 901 Nitra

Tel.: 037/ 7777 911 Email: sale@bibus.sk
Fax.: 037/ 7777 999 <http://www.bibus.sk>

DIPLOMATIC
MOTION SOLUTIONS

DIPLOMATIC MS S.p.A.

via M. Re Depaolini 24 ▪ 20015 PARABIAGO (MI) ▪ ITALY
tel. +39 0331.895.111 ▪ www.diplomatic.com ▪ e-mail: sales.exp@diplomatic.com