



BOSCHERT

Das Original!



www.boschert.de
infokl@boschert.de



Viac ako 65 rokov partnerstva s našimi zákazníkmi

Zákaznícky servis, spoľahlivosť, kvalita a pružnosť sú základy našej spoločnosti viac ako 65 rokov. Ako zákazník sa už od začiatku stanete súčasťou nášho tímu a pri plnení vašich požiadaviek vám poskytneme našu plnú podporu. Počúvame vás. Jednáme, inovujeme a reagujeme rýchlo.

S istotou môžete nájsť toho najlepšieho partnera, nám môžete sviesť riešenie vašich technických problémov. Naši technici a inžinieri vám poskytnú to najlepšie a najbezpečnejšie riešenie. Naše skúsenosti nashromáždžené za niekoľko desiatok rokov sú vám plne k dispozícii.

Naším cieľom je nabízať všetkým našim zákazníkom po celom svete to najlepšie možné riešenie. To je tajomstvo nášho úspechu po viac než polstoročí. Vitáme vás ako zákazníka a zveme vás, aby ste sa pripojili k nášmu tímu. Určujeme štandard v odbore. Jsme číslo jedna na celom svete!

Jsme vám vždy k dispozícii.

Over 65 Years of partnership with our customers

Customer service, reliability, quality and flexibility are the foundation of our company for more than 65 years. As a customer you become a part of our team from the beginning. You have our complete attention to fulfill your requirements. We listen to you. We act, innovate, and react quickly.

With the assurance that you have found the best source, you can trust us to use the solution of the technical problems of your application. You can expect our technicians and engineers to provide you with the best and safest solution for your application. We have decades of service at your command.

It is our goal to offer all our customers, all over the world, the best solution possible. This is the secret to our success for over half a century. We welcome you as a customer and invite you to join our team. We are the standard of the industry. We are number one in all the world!

We are always available for you.

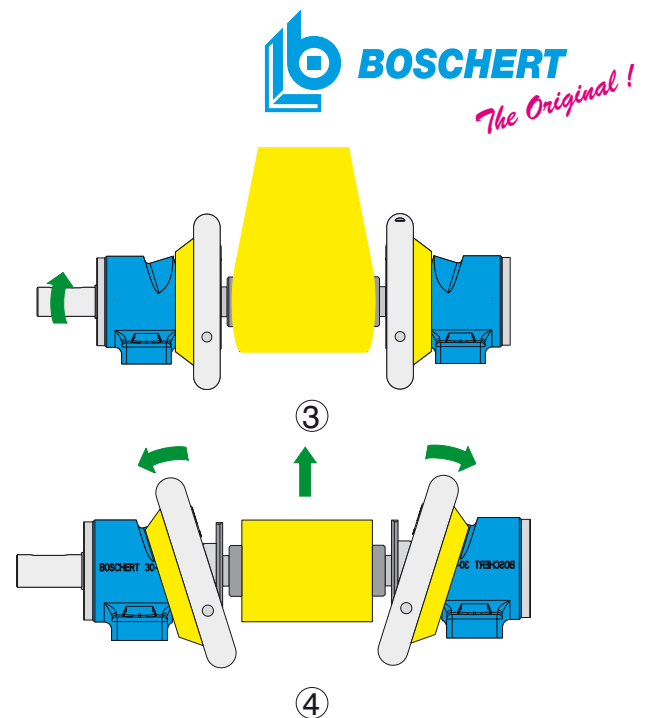
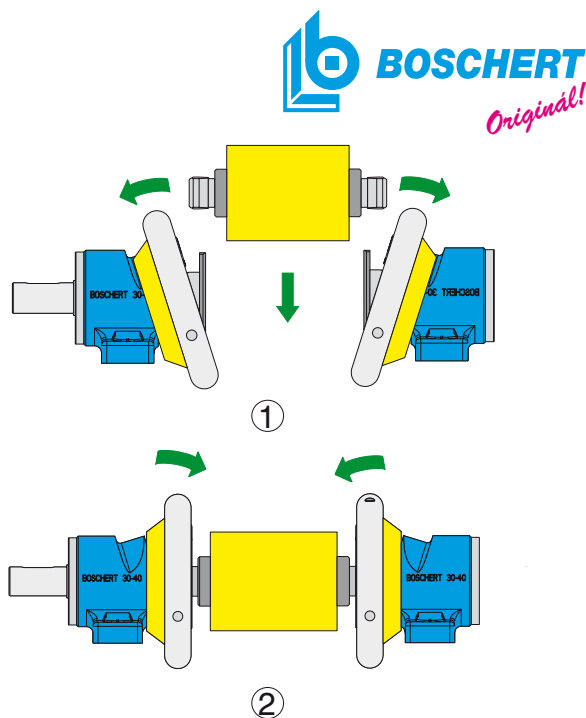

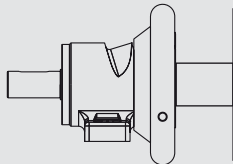

Bezpečnostné zaklapávacie uloženia

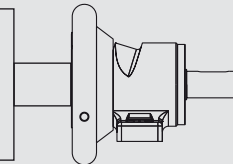

Typ Model	Max. hmotnosť / kg (max. beam weight / lbs)	Max. krútiaci moment / Nm (max. torque / ft/lb)	Veľkosť čtýhranu / mm (Square bar / inch)	Uložení typu C Type C	Uložení typu VT Type VT	Výmenné vložky Wear plates
Mini	150 (330)	40 (29.5)	14-20 (0.5512 - 0.7874)	x		
19-25	400 (880)	120 (88.5)	19-25 (0.748 - 0.9843)	x		
22-30	800 (1760)	180 (132.8)	22-30 (0.8661 - 1.1811)	x	x	
30-40	1600 (3530)	350 (258.1)	30-40 (1.1811 - 1.5748)	x	x	
40-50	2800 (6170)	1100 (800)	40-50 (1.5748 - 1.9685)	x	x	
50-80	7000 (15430)	2350 (1700)	50-80 (1.9685 - 3.1496)		x	
80-120	12000 (24460)	10000 (7230)	80-120 (3.1496 - 4.7244)		x	
120-180	22000 (48500)	20000 (14468)	120-180 (4.7244 - 7.0866)			x
170-230	64000 (141090)	41000 (29660)	170-230 (6.6929 - 9.0551)			x

Různé tvary vložek Different insert shapes

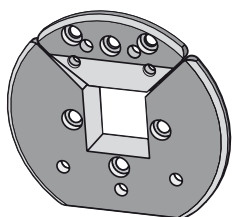

VT 1

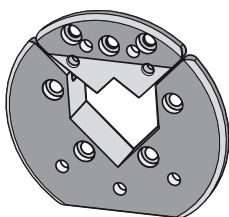

VT 2

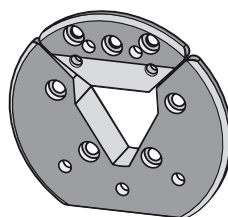

VT 6

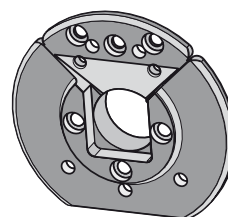

VT 7

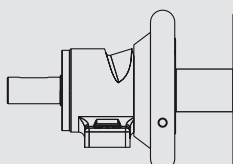

Safety chucks

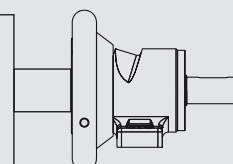



Posuvné uloženia

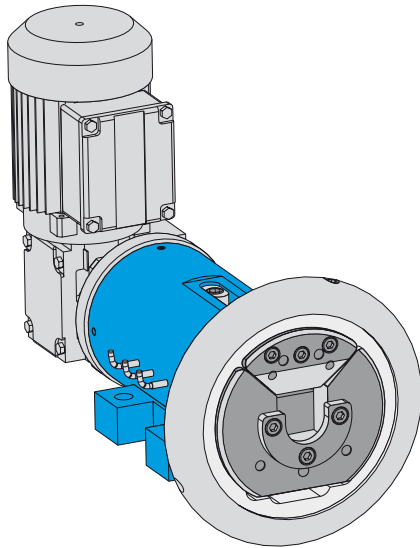
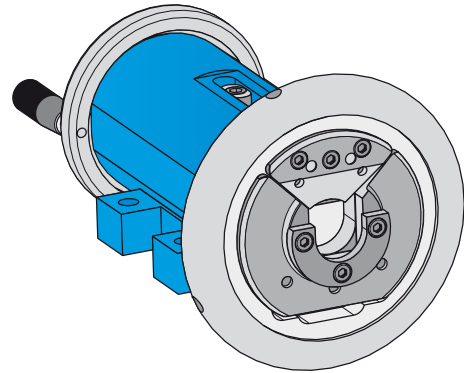
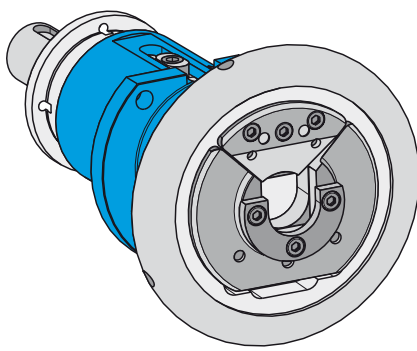

Typ Model	Max. hmotnosť / kg (max. beam weight / lbs)	Max. krútiaci moment / Nm (max. torque / ft/lb)	Veľkosť čtŕhranu / mm (Square bar / inch)	Uložení typu VT Type VT
22-30	800	180	22-30	x
	(1760)	(132.8)	(0.8661 - 1.1811)	
30-40	1600	350	30-40	x
	(3530)	(258.1)	(1.1811 - 1.5748)	
40-50	2800	1100	40-50	x
	(6170)	(800)	(1.5748 - 1.9685)	

Seřízení: 50 mm / 100 mm
Adjustment:

Volitelně: motorizované seřizování

Option: motorized adjustment

Různé tvary vložek
Different insert shapes

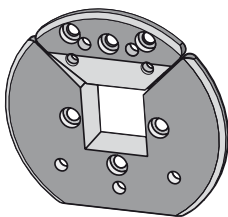

VT 1

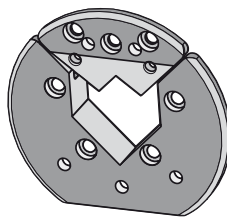

VT 2

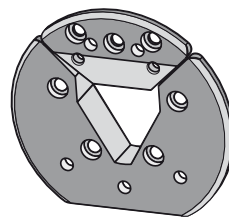

VT 6

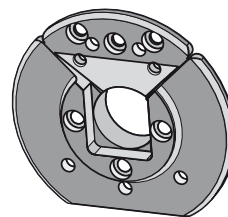

VT 7

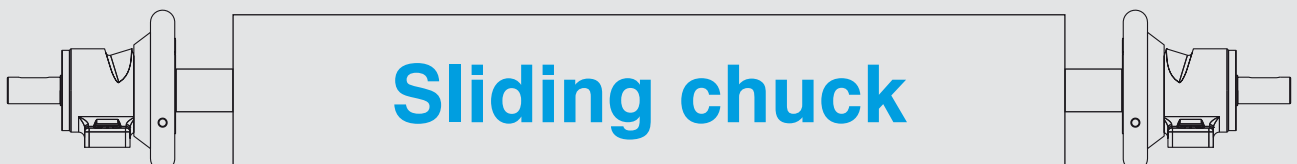

Sliding chuck

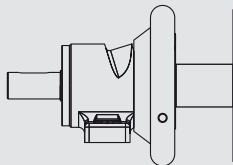

Pneumatické uloženia

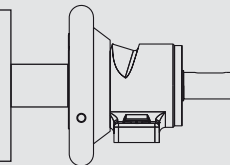

Řada A
A series

Typ Model	Max. hmotnosť / kg (max. beam weight / lbs)	Max. krútiaci moment / Nm (max. torque / ft/lb)	Veľkosť čtýhranu / mm (Square bar / inch)	Uložení typu VT Type VT
A40	1600 (3530)	350 (250)	40 (1.5748)	x
A50	2800 (6170)	1100 (800)	50 (1.9658)	x
A80	7000 (15430)	2350 (1700)	80 (3.1496)	x

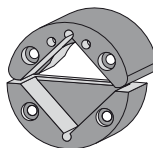

VT 2



Řada P
P series

Typ Model	Max. hmotnosť / kg (max. beam weight / lbs)	Max. krútiaci moment / Nm (max. torque / ft/lb)	Veľkosť čtýhranu / mm (Square bar / inch)	Uložení typu VT Type VT
P40	1600 (3530)	350 (250)	40 (1.5748)	x
P50	2800 (6170)	1100 (800)	50 (1.9658)	x

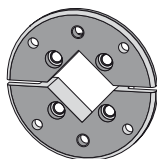

VT2

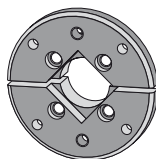

VT 7

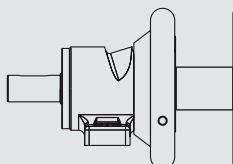

Pneumatic chuck

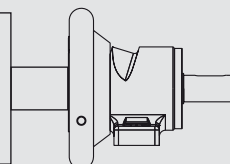

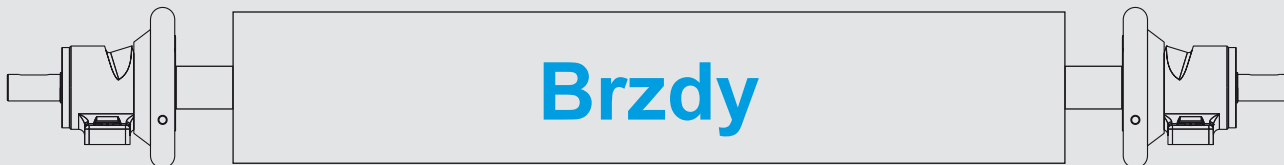

Brzdy

Brzdy	ESB	DSB	Multi
max. brzdný krouticí moment	30 - 110 Nm	200 - 440 Nm	120 - 1200 Nm
pro uložení:	Mini / 19-25 / 22-30 / 30-40 / 40-50 / 50-80 / Posuvná uložení / Řada A / Řada P		



Brakes	ESB	DSB	Multi
max. brake torque	22 - 800 ft/lb	140 - 320 ft/lb	87 - 870 ft/lb
for Safety chuck:	Mini / 19-25 / 22-30 / 30-40 / 40-50 / 50-80 / Sliding Chucks / Series A / Series P		



ESB / DSB

Multi

Pro jednoduché aplikace jsou s bezpečnostními zaklapávacími uloženími použitelné jednoduché kotoučové brzdy a dvojité kotoučové brzdy.

Brzdový systém je k dispozici v různých verzích:

- ruční, pneumatický, pneumatický s membránovým ovládacím válcem

Single disc brakes and Double disc brakes are usable for simple applications with safety chucks.

The brake system is available in different versions

- manual, pneumatical, pneumatical with membrane cylinder

- snadno přizpůsobitelné různým rozsahům krouticích momentů a požadavkům na výkon
- rychlá a snadná výměna brzdových obložení
- větraný kotouč brzdy
- přizpůsobitelné mnoha různým montážním uspořádáním
- atraktivní poměr cena/výkon
- široký rozsah krouticích momentů a požadavků na výkon
- široký výběr standardních dílů usnadňuje údržbu
- tlumiče brzdového obložení snižují hluk a vibrace
- více než brzda s bezpečnostním zaklapávacím uložení – brzda s všestranným použitím

- easily adaptable to different torque ranges and power requirements
- quick and easy change out of the brake linings
- ventilated brake rotor
- adaptable to many different mounting arrangements
- better value for your purchase price
- wide range of torque and performance requirements
- our huge inventory of these standard parts makes maintenance easy and less expensive
- brake pad dampeners reduce noise and vibration
- more than a safety chuck brake - a brake for use in all applications

Všechny naše brzdy jsou připraveny pro použití s uloženími Boschert.

Další informace naleznete v katalogu nebo nás kontaktujte

All our brakes are adjusted to fit to Boschert Chucks.

For more information please have a look at the catalog or contact us.

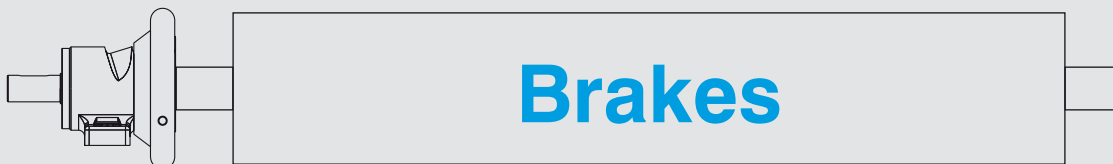

Brakes



Easy Wind

Easy Wind Easy Wind Twin Easy Wind Sensitive

Regulace tahu „Plug and Play“

- snadná instalace
- konstantní tah v celém průměru
- ultrazvukové čidlo měřící průměr role
- snadné používání

The „Plug and Play“ Tension Control

- easy installation
- constant tension over whole diameter
- ultrasonic sensor measuring the roll diameter
- simple to use

Easy Wind:

Standardní řešení pro jednu roli
Standard solution for one roll

Easy Wind Twin:

Řešení pro dvě role (dvě čidla, jedna ovládací jednotka)
The solution for two rolls (two sensors, one control unit)

Easy Wind Sensitive:

Každá brzdová čelist může být ovládána samostatně.
Each brake caliper can be shut on or off



Easy Wind

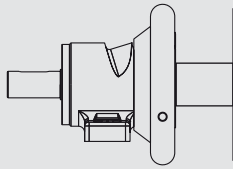

Tým bezpečnostných zaklapávacích uložení Safety chuck team

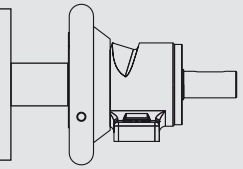

Helmut Turowski

Manažer prodeje
Sales manager

Phone: + 49 (0) 7621 - 9593 - 36
E-mail: h.turowski@boschert.de



Silvia Schwarzwälder

Prodej bezpečnostných zaklapávacích uložení
Sales Safety Chucks

Phone: + 49 (0) 7621 - 9593 - 26
E-mail: s.schwarzwaelder@boschert.de



Sabrina Wehrle

Prodej bezpečnostných zaklapávacích uložení
Sales Safety Chucks

Phone: + 49 (0) 7621 - 9593 - 74
E-mail: s.wehrle@boschert.de



Antoine Pelayo

Projektant
Designer

Phone: + 49 (0) 7621 - 9593 - 37
E-mail: a.pelayo@boschert.de

BIBUS
SUPPORTING YOUR SUCCESS

Trnavská 31
SK-94901 Nitra
Slovak Republic

Phone: + 421 377 777 911
Fax: + 421 377 777 999
E-mail: sale@bibus.sk
Internet: www.bibus.sk