

AirTAC INTERNATIONAL GROUP

Europe

AirTAC

## PRODUCTS CATALOG

- G thread fittings
- G thread Silencer
- G thread Speed controller
- Polyurethane re-coil hosepart
- PT thread fittings
- PT thread Silencer
- PT thread Speed controller



[www.airtac.com](http://www.airtac.com)

Global Automation Equipment Manufacturer's Long-term Strategic Partnership



# AirTAC ● Pneumatic Equipment

**G thread fittings**

**G thread Silencer**

**G thread Speed controller**

**Polyurethane re-coil hosepart**



























**PT thread fittings**

**PT thread Silencer**

**PT thread Speed controller**



The accessories is necessary for intact air system. AirTAC has many types of accessories for your choice:  
1. G thread Fitting; 2. G thread Silencer; 3. G thread Speed Controller; 4. Polyurethane re-coil Hosepart.  
5. PT thread Fitting; 6. PT thread Silencer; 7. PT thread Speed Controller.

<b>Threaded type (G Thread)</b>	<b>GPC Series</b>  6	<b>GPC-M Series</b>  7	<b>GPL-M Series</b>  7	<b>GPL Series</b>  9
	<b>GPCF Series</b>  9	<b>GPMF Series</b>  9	<b>GPLF Series</b>  9	<b>GPLL Series</b>  10
	<b>GPHW Series</b>  10	<b>GPH Series</b>  10	<b>GPHF Series</b>  10	<b>GPKD Series</b>  10
	<b>GPEB Series</b>  11	<b>GPYB Series</b>  11	<b>GPED Series</b>  11	<b>GPZB Series</b>  11
<b>Metal one-touch fittings (G Thread)</b>	<b>GBPC Series</b>  13	<b>GBPMF Series</b>  13	<b>GBPCF Series</b>  13	<b>GBPM Series</b>  13
	<b>GBB, GBD Series</b>  14	<b>GBU Series</b>  14	<b>GBZ Series</b>  14	<b>GBKC Series</b>  15
<b>Tube-tube type</b>	<b>GPE Series</b>  17	<b>GPU Series</b>  17	<b>GPY Series</b>  17	<b>GPM Series</b>  17
	<b>GPV Series</b>  17	<b>GPLM Series</b>  17	<b>GPYW Series</b>  18	<b>GPEG Series</b>  18



Tube-tube type	<b>GPZ Series</b>  <b>18</b>	<b>GPEW Series</b>  <b>18</b>	<b>GPG Series</b>  <b>18</b>	<b>GPP Series</b>  <b>18</b>
	<b>GPGJ Series</b>  <b>19</b>	<b>GPZG Series</b>  <b>19</b>	<b>GPHK Series</b>  <b>19</b>	<b>GPHD Series</b>  <b>19</b>
	<b>GPKG Series</b>  <b>19</b>			
Speed controllers (G Thread)	<b>GPSS Series</b>  <b>21</b>	<b>GPSA Series</b>  <b>21</b>	<b>GPTL-M Series</b>  <b>24</b>	<b>GPTL Series</b>  <b>25</b>
	<b>GPHV Series</b>  <b>27</b>			
Silencers (G Thread)	<b>GBSL Series</b>  <b>29</b>	<b>GBSLM Series</b>  <b>29</b>	<b>GBESL Series</b>  <b>29</b>	
	<b>US98A, UE95A Series</b>  <b>30</b>	<b>UCS Series</b>  <b>31</b>		
Flame resistant tube	<b>UN54D Series</b>  <b>32</b>			



<b>Threaded type (PT Thread)</b>	<b>PC, POC Series</b>  33	<b>PC-M Series</b>  34	<b>PL-M Series</b>  34	<b>PL Series</b>  36
	<b>PCF Series</b>  36	<b>PMF Series</b>  36	<b>PLF Series</b>  36	<b>PLL Series</b>  37
	<b>PHW Series</b>  37	<b>PH Series</b>  37	<b>PHF Series</b>  37	<b>PKD Series</b>  37
	<b>PEB Series</b>  38	<b>PYB Series</b>  38	<b>PED Series</b>  38	<b>PZB Series</b>  38
<b>Metal one-touch fittings (PT Thread)</b>	<b>BPC Series</b>  40	<b>BPOC Series</b>  40	<b>BPMF Series</b>  40	<b>BPCF Series</b>  40
	<b>BB, BD Series</b>  41	<b>BU Series</b>  41	<b>BZ Series</b>  41	<b>BKC Series</b>  42
	<b>BSL Series</b>  44	<b>BSLM Series</b>  44	<b>BESL Series</b>  44	<b>PAL, PALM Series</b>  44
<b>Speed controllers (PT Thread)</b>	<b>PSL Series</b>  46	<b>PSS Series</b>  46	<b>PTL-M Series</b>  48	<b>PTL Series</b>  49





## Installation and Operation of tube and fitting

### 1. Installation and removal of tubing:

#### 1.1. Installation of tubing

Grasp the tubing and slowly push it into the fitting until it comes to a stop. The tubing will be locked by the spring gasket.

#### 1.2. Removal of tubing

Push the release button to open the spring gasket so that the tubing can be released.

Note: When remove the tubing, make sure the pressure in the tubing is Zero.

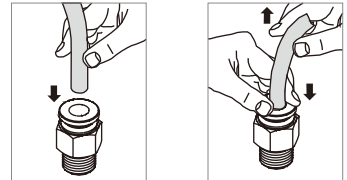

### 2. Connection thread tightening method

Use an inner or outer hexagon wrench to tighten the fitting as show in the picture below.

Note: Please refer to the tables below for the tightening torque.

Recommended tightening torque(N.m)						
Thread type	M3	M5	1/8"	1/4"	3/8"	1/2"
Tightening torque	0.3~0.6	1~1.5	5~8	6~9	8~11	12~16

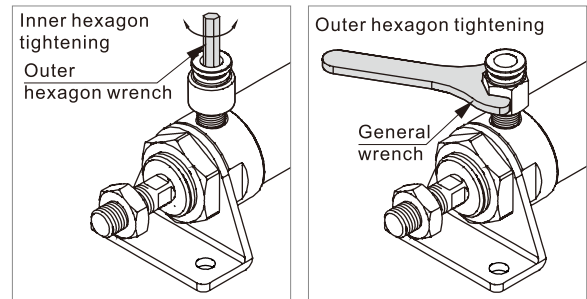

### 3. Caution

3.1. External force (bend, twist, and tension) may damage the fitting and cause air leakage.

3.2. Insufficient installation may cause air leakage or the tubing to release.

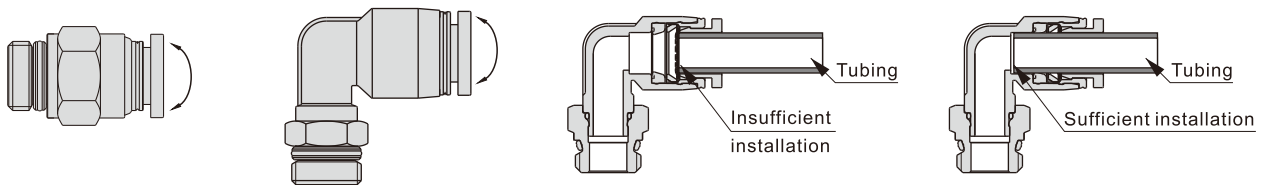

3.3. Pulling or twisting the tubing excessively may damage the fitting. For a mounting guide, see the table below.

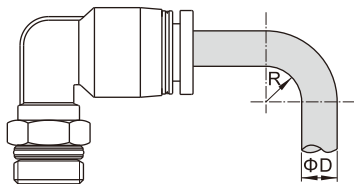

Minimum bending radius of the tubing(mm)						
Tubing O.D.(ΦD)	3.2	4	6	8	10	12
Minimum bending radius(R)	15	20	30	50	80	150

### 4. Connection thread tightening method of the fitting with M5 type thread

First, tighten by hand, then use a wrench to tighten an additional 1/4 turn. Excessive tightening may damage the thread portion or deform the gasket and cause air leakage. Insufficient tightening may loosen the threads, or cause air leakage.

### 5. Tolerance of the Polyurethane tubing O.D.

Polyurethane tubing O.D.(mm)	3.2	4	6	8	10	12
Tolerance(mm)	±0.1	±0.1	±0.1	±0.1	±0.15	±0.15



Notes



## Other precautions

1. Before piping is connected, it should be washed to remove chips and other debris from inside the pipe.
2. Ensure the tubing being cut perpendicularly and no damage or scratch on the surface of the tubing outside diameter.
3. Use pipe length with sufficient margin to avoid over-bending on the top of the fitting.
4. Pull the tubing back gently to make sure it has a positive seal before using.
5. Push the release button flange evenly and sufficiently to release the button. If the release button is not held down sufficiently, the tubing cannot be with drawn and the outer surface of the tubing may be scratched and cause air leakage.
6. When removing tubing, do not rotate around or 360 degree. This may result in scratch and removal of the tubing difficult.
7. When screwing together pipes and fittings, be certain that chips from the pipe threads and sealing material do not get inside the pipe. Also, when the pipe tape is used, leave approx. 1.5~2 thread ridges exposed at the end of the threads.



### Notes

## Safety instructions

1. When remove the tubing, make sure the pressure in the tubing is Zero.
2. Do not use the ordinary fittings and tubing in locations where spatter is generated. Spattering may result in a fire hazard.
3. Ensure that the pressure and ambient temperature are within the specified range.
4. Do not use in an atmosphere having corrosive gases, chemicals, sea water, water, water steam, or where there is direct contact with any of these.
5. Do not use in a place subject to heavy vibration and/or shock.



### Warning

## GPC series

### Ordering code

GPC 6 01 □

① ② ③ ④

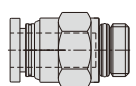
① Model	② Port size	③ Thread connection		④ Standard color	
GPC: Male connector (G thread) 	6: Φ6mm 8: Φ8mm 10: Φ10mm 12: Φ12mm	Thread connection M5: M5X0.8 01: G1/8 02: G1/4 03: G3/8 04: G1/2	Adaptable port size Φ6  Φ6, Φ8, Φ10, Φ12	Standard color Blank: Gray D: Black	Specification Release button: Gray Release button: Black

### Specification

<b>Operating pressure range</b>	<b>0~10kgf/cm<sup>2</sup>(0~1.0MPa)</b>
Negative pressure	-750mmHg(10Torr)
Proof pressure	1.5MPa
Ambient and fluid temperature (°C)	-20~70
Applicable tubing	Soft nylon or polyurethane
Color	Gray/black

### Table for interface port and tube O.D.

Product series	Thread type	Port size			
		Φ6	Φ8	Φ10	Φ12
GPC	M5	●			
	G1/8	●	●	●	●
	G1/4	●	●	●	●
	G3/8	●	●	●	●
	G1/2	●	●	●	●

### Product feature

1. The compact appearance space saving.

2. Gray and black are optional for the release button.

3. The threaded portion is attached with a sealing gasket to prevent air leakage over the connection thread portion.



### Inner structure

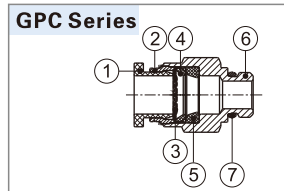

No.	Item	Material
1	Release button	POM
2	Guide	Aluminum alloy
3	Spring gasket	Stainless steel
4	Chuck	POM
5	O-ring	NBR
6	Body	Brass
7	O-ring	NBR

### Dimensions

#### GPC Series

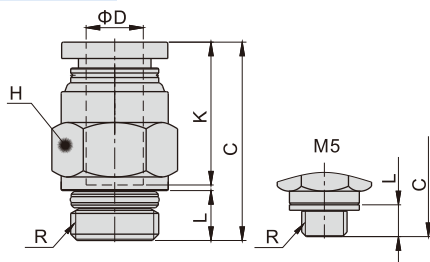

Model/Item	ΦD	R	L	C	K	H(Across flat)	Weight(g)	PCS/bag
GPC6M5	6	M5×0.8	3.5	22.5	16.5	12	8.5	10
GPC601		G1/8	5.5	22	16.35	12	7.1	10
GPC602		G1/4	6.5	21	16.35	14	11.5	10
GPC603		G3/8	7	20.5	16.35	19	23.2	10
GPC604		G1/2	8.5	20.5	16.35	22	37.9	10
GPC801	8	G1/8	5.5	26	18.5	14	10.7	10
GPC802		G1/4	6.5	25	18.5	14	10.5	10
GPC803		G3/8	7	22	18.5	19	21.5	10
GPC804		G1/2	8.5	23.5	18.5	22	36.2	10
GPC1001	10	G1/8	5.5	29.5	20.9	17	13.2	10
GPC1002		G1/4	6.5	29	20.9	17	15.8	10
GPC1003		G3/8	7	25	20.9	19	18.2	10
GPC1004		G1/2	8.5	23.5	20.9	22	30.7	10
GPC1201	12	G1/8	5.5	32	22.7	21	22.3	10
GPC1202		G1/4	6.5	33	22.7	21	25.4	10
GPC1203		G3/8	7	30.5	22.7	21	23.6	10
GPC1204		G1/2	8.5	27.5	22.7	22	31.7	10



## GPC, GPL mini series

### Ordering code

GPC 6 01 □ - M

① ② ③ ④ ⑤

① Model	② Port size	③ Thread connection		④ Standard color		⑤ Style type
GPC: Male connector (G thread) 	3.2: $\Phi$ 3.2mm 4: $\Phi$ 4mm 6: $\Phi$ 6mm	Thread connection	Adaptable port size	Standard color	Specification	M: Mini type
GPL: Male elbow (G thread) 		M3: M3X0.5	$\Phi$ 3.2, $\Phi$ 4	Blank: Gray	Release button: Gray	
		M5: M5X0.8	$\Phi$ 3.2, $\Phi$ 4, $\Phi$ 6		Release button: Black	
	01: G1/8	$\Phi$ 4, $\Phi$ 6	D: Black			
		02: G1/4	$\Phi$ 4			

### Specification

<b>Operating pressure range</b>	<b>0~10kgf/cm<sup>2</sup>(0~1.0MPa)</b>
Negative pressure	-750mmHg(10Torr)
Proof pressure	1.5MPa
Ambient and fluid temperature (°C)	-20~70
Applicable tubing	Soft nylon or polyurethane
Color	Gray/black

### Table for interface port and tube O.D.

Product series	Thread type	Port size		
		$\Phi$ 3.2	$\Phi$ 4	$\Phi$ 6
GPC GPL	M3	●	●	
	M5	●	●	●
	G1/8		●	●
	G1/4		●	

### Product feature

1. The compact appearance space saving.
2. The threaded portion is attached with a sealing gasket to prevent air leakage over the connection thread portion.
3. Gray and black are optional for the release button.

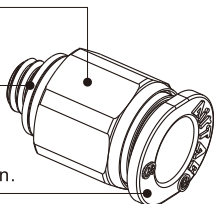

### Dimensions

#### GPC Series

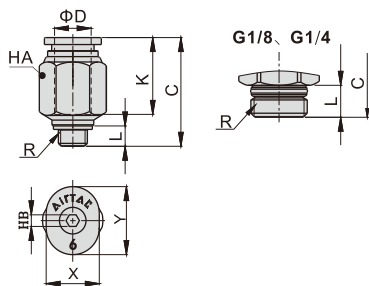

#### GPL Series

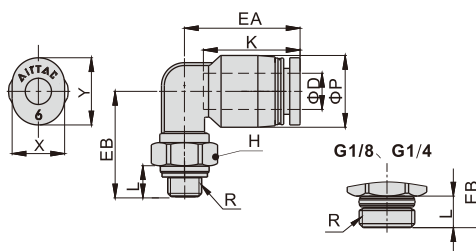

Model\Item	ΦD	R	L	C	K	X	Y	HA	HB	Weight(g)	PCS/bag
GPC3.2M3-M	3.2	M3×0.5	3	16	11.5	6.8	8.7	7	1.5	1.7	10
GPC3.2M5-M		M5×0.8	3.5	16	11.5	6.8	8.7	7	2	2.0	10
GPC4M3-M	4	M3×0.5	3	17.5	12.5	7.8	9.5	8	1.5	2.4	10
GPC4M5-M		M5×0.8	3.5	17	12.5	7.8	9.5	8	2	2.7	10
GPC401-M		G1/8	5.5	16	13.5	7.8	9.5	10	3	3.6	10
GPC402-M	G1/4	6.5	16.5	13.5	7.8	9.5	14	3	9.5	10	
GPC6M5-M	6	M5X0.8	3.5	18.5	13.5	9.8	11.7	10	2	3.6	10
GPC601-M		G1/8	5.5	18.5	15.5	9.8	11.7	11	4	6.0	10

Model\Item	ΦD	R	ΦP	L	K	EA	EB	H	X	Y	Weight(g)	PCS/bag
GPL3.2M3-M	3.2	M3×0.5	7.5	3	12	14.5	14	7	6.8	8.7	2.4	10
GPL3.2M5-M		M5×0.8		3.5	12		14.5	7	6.8	8.7	2.7	10
GPL4M3-M	4	M3×0.5	8.5	3	12.5	15	14	7	7.8	9.5	3.0	10
GPL4M5-M		M5×0.8		3.5	12.5		14.5	7	7.8	9.5	3.3	10
GPL401-M		G1/8		5.5	12.5		14	10	7.8	9.5	6.2	10
GPL402-M	G1/4	6.5	12.5	16.5	14	7.8	9.5	14.1	10			
GPL6M5-M	6	M5X0.8	10.5	3.5	13.5	16.0	15.5	7	9.8	11.7	4.0	10
GPL601-M		G1/8		5.5	13.5		14.5	10	9.8	11.7	6.8	10

## One-touch fittings—threaded type

### Ordering code

Same diameter type fittings

GPL 6 01 □

① ② ③ ④

① Model	② Port size	③ Thread connection	④ Standard color
GPHW: Double universal male elbow (G thread) 	GPL: Male elbow (G thread) 	Thread connection Adaptable port size	Standard color Specification Release button: Gray Adaptable model GPCF GPMF
GPHF: Universal female elbow (G thread) 	GPLL: Extended male elbow (G thread) 	M5: M5X0.8 Φ4, Φ6	Blank: Gray Release button: Gray Body: Gray Others
GPEB: Male branch tee (G thread) 	GPLF: Female elbow (G thread) 		
GPED: Male run tee (G thread) 	GPCF: Female connector (G thread) 	4: Φ4mm 6: Φ6mm 8: Φ8mm 10: Φ10mm 12: Φ12mm	Release button: Black GPCF GPMF
GPYB: Branch "Y" (G thread) 	GPMF: Bulkhead connector (G thread) 		
GPZB: Threaded cross (G thread) 	GPH: Universal male elbow (G thread) 	01: G1/8 02: G1/4 03: G3/8 04: G1/2	D: Black Release button: Black Body: Black Others

Different diameter type fittings

GPKD 6-4 01 □

① ② ③ ④ ⑤

① Model	② Port size	③ Port size	④ Thread connection	⑤ Standard color
GPKD: Male reducer triple branch (G thread) 	6: Φ6mm 8: Φ8mm 10: Φ10mm	4: Φ4mm 6: Φ6mm 8: Φ8mm	01: G1/8 02: G1/4 03: G3/8	Standard color Specification Blank: Gray Release button: Gray/Body: Gray D: Black Release button: Black/Body: Black

### Specification

<b>Operating pressure range</b>	0~10kgf/cm <sup>2</sup> (0~1.0MPa)
Negative pressure	-750mmHg(10Torr)
Proof pressure	1.5MPa
Ambient and fluid temperature (°C)	-20~70
Applicable tubing	Soft nylon or polyurethane
Color	Gray/black

### Product feature

- Variable models can be widely used in every kind of pneumatic systems.
- High circulation performance: bear the same flow with the volume of the tubing inside diameter.
- Connect tubing easily and conveniently. The tubing connection portion is safe and durable.
- The thread is attached with a sealing gasket to prevent air leakage over the connection thread portion.
- The nickel plated body is anti-corrosion and anti-pollution, which allows a broader application.

### Inner structure

GPL Series		No.	Item	Material
		1	Release button	POM
		2	Guide	Aluminum alloy
		3	Spring gasket	Stainless steel
		4	Chuck	POM
		5	O-ring	NBR
		6	Body	PBT
		7	O-ring	NBR
		8	Stud	Brass
		9	O-ring	NBR

### Table for interface port and tube O.D.

Product series	Thread type	Port size				
		Φ4	Φ6	Φ8	Φ10	Φ12
GPL	M5	●				
	G1/8	●	●	●	●	●
	G1/4	●	●	●	●	●
	G3/8	●	●	●	●	●
	G1/2	●	●	●	●	●
GPLL	M5	●	●			
	G1/8	●	●	●	●	
	G1/4	●	●	●	●	●
	G3/8	●	●	●	●	●
GPLF	M5	●	●			
	G1/8	●	●	●	●	
	G1/4	●	●	●	●	●
	G3/8	●	●	●	●	●
GPCF	M5	●	●			
	G1/8	●	●	●	●	
	G1/4	●	●	●	●	●
	G3/8	●	●	●	●	●
GPMF	M5	●	●			
	G1/8	●	●	●	●	
	G1/4	●	●	●	●	●
	G3/8	●	●	●	●	●
GPH	M5	●	●			
	G1/8	●	●	●	●	
	G1/4	●	●	●	●	●
	G3/8	●	●	●	●	●
GPHF	M5	●	●			
	G1/8	●	●	●	●	
	G1/4	●	●	●	●	●
	G3/8	●	●	●	●	●
GPHW	M5	●	●			
	G1/8	●	●	●	●	
	G1/4	●	●	●	●	●
	G3/8	●	●	●	●	●
GPZB	M5	●	●			
	G1/8	●	●	●	●	
	G1/4	●	●	●	●	●
	G3/8	●	●	●	●	●

Product series	Thread type	Port size		
		Φ6-Φ4	Φ8-Φ6	Φ10-Φ8
GPKD	G1/8	●		
	G1/4		●	
	G3/8			●





# Accessories—One-Touch Fittings



## One-touch fittings—threaded type

### GPLL Series

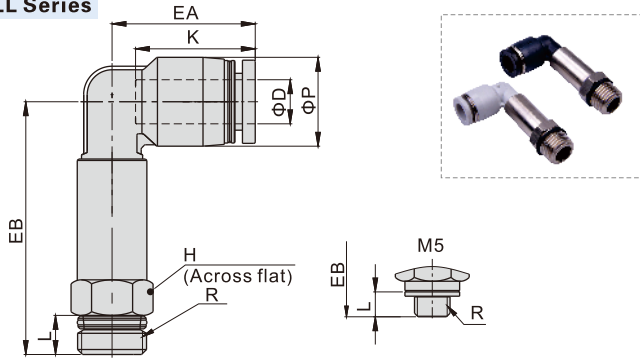

Model/Item	ΦD	R	ΦP	L	K	EA	EB	H	Weight(g)	PCS/bag
GPLL4M5	4	M5×0.8	9	3.5	14	17	32.5	8	8.9	10
GPLL401		G1/8	9	5.5	14	17	33.5	10	11.4	10
GPLL402		G1/4	9	6.5	14	17	36.5	14	15.3	10
GPLL6M5	6	M5×0.8	12.5	3.5	17	20	34.5	8	9.9	10
GPLL601		G1/8	12.5	5.5	17	20	35.5	10	12.1	10
GPLL602		G1/4	12.5	6.5	17	20	38.5	14	16.4	10
GPLL603		G3/8	12.5	7	17	20	41	19	24	10
GPLL801	8	G1/8	15	5.5	18.5	23	43	12	16.4	10
GPLL802		G1/4	15	6.5	18.5	23	43.5	14	21.1	10
GPLL803		G3/8	15	7	18.5	23	46	19	28.5	10
GPLL1001	10	G1/8	18	5.5	21	25.5	50	15	37.3	10
GPLL1002		G1/4	18	6.5	21	25.5	51.5	15	39	10
GPLL1003		G3/8	18	7	21	25.5	52.5	19	41.5	10
GPLL1004		G1/2	18	8.5	21	25.5	53.5	22	44.1	10
GPLL1202	12	G1/4	21	6.5	23	28.5	56	15	44	10
GPLL1203		G3/8	21	7	23	29.5	58	19	56.8	10
GPLL1204		G1/2	21	8.5	23	29.5	59.5	22	53.4	10

### GPHW Series

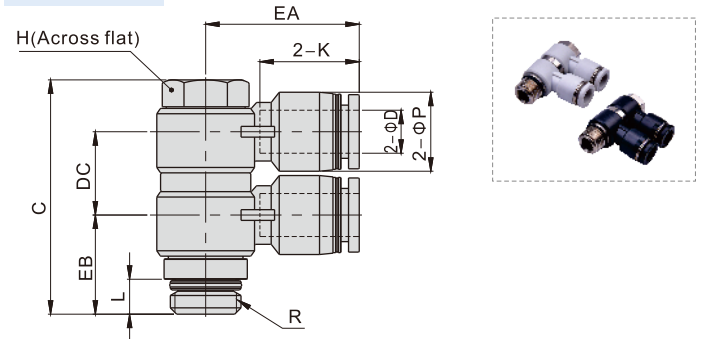

Model/Item	ΦD	R	ΦP	L	C	K	EA	EB	DC	H	Weight(g)	PCS/bag
GPHW401	4	G1/8	9	5.5	38	14	20.5	14.5	13	11	19	10
GPHW601	6	G1/8	12.5	5.5	38	16.5	23.0	15	13	11	21	10
GPHW602		G1/4	12.5	6.5	43.5	16.5	25.0	17.5	15.5	14	40.2	10
GPHW603		G3/8	12.5	7	50	16.5	27.0	20	16.5	19	69.2	5
GPHW801	8	G1/8	15	5.5	40.5	18.5	26.5	16.5	15.5	11	23.6	10
GPHW802		G1/4	15	6.5	43.5	18.5	28.5	18.5	15.5	14	40.8	10
GPHW803		G3/8	15	7	50	18.5	29.5	20	16.5	19	70.4	5
GPHW804		G1/2	15	8.5	61	18.5	32	24.5	22	24	134.8	5
GPHW1002	10	G1/4	18	6.5	46.5	21	31	20	18.5	14	47	10
GPHW1003		G3/8	18	7	55	21	33	21	22	19	87.5	5
GPHW1004		G1/2	18	8.5	61	21	35.5	25	22	24	137.7	5
GPHW1203	12	G3/8	21	7	55	23	36	23	22	19	86.4	5
GPHW1204		G1/2	21	8.5	61	23	38	26.5	22	24	147.5	5

### GPH Series

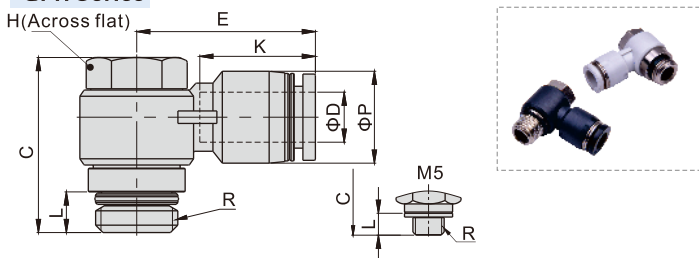

Model/Item	ΦD	R	ΦP	L	C	K	E	H	Weight(g)	PCS/bag
GPH4M5	4	M5×0.8	9	3.5	17	14	19	8	5.8	10
GPH401		G1/8	9	5.5	25	14	20.5	11	12.8	10
GPH6M5	6	M5×0.8	12.5	3.5	17	16.5	23.5	8	6.8	10
GPH601		G1/8	12.5	5.5	25	16.5	23	11	14	10
GPH602		G1/4	12.5	6.5	28	16.5	25	14	25.4	10
GPH603		G3/8	12.5	7	33	16.5	27	19	50.2	5
GPH801	8	G1/8	15	5.5	25	18.5	26.5	11	14.7	10
GPH802		G1/4	15	6.5	28	18.5	28.5	14	26.4	10
GPH803		G3/8	15	7	33	18.5	29.5	19	49.4	5
GPH804		G1/2	15	8.5	39	18.5	32	24	89	5
GPH1002	10	G1/4	18	6.5	28	21	31	14	27.7	10
GPH1003		G3/8	18	7	33	21	33	19	51.1	5
GPH1004		G1/2	18	8.5	39	21	35.5	24	88.5	5
GPH1203	12	G3/8	21	7	33	23	36	19	53	5
GPH1204		G1/2	21	8.5	39	23	38	24	92.8	5

### GPHF Series

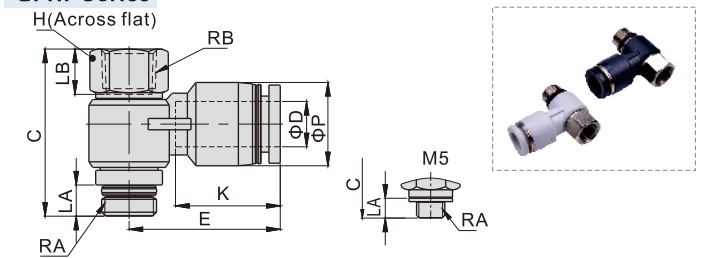

Model/Item	ΦD	RA	RB	ΦP	LA	LB	C	K	E	H	Weight(g)	PCS/bag
GPHF4M5	4	M5×0.8	M5×0.8	9	3.5	6	20	14	19	8	6.2	10
GPHF401		G1/8	G1/8	9	5.5	8	29.5	14	20.5	12	12.9	10
GPHF6M5	6	M5×0.8	M5×0.8	12.5	3.5	6	20	16.5	23.5	8	7.1	10
GPHF601		G1/8	G1/8	12.5	5.5	8	29.5	16.5	23	12	13.9	10
GPHF602		G1/4	G1/4	12.5	6.5	11	35	16.5	25	17	30.3	10
GPHF603		G3/8	G3/8	12.5	7	12	40	16.5	27	19	44.2	5
GPHF801	8	G1/8	G1/8	15	5.5	8	29.5	18.5	26.5	12	15	10
GPHF802		G1/4	G1/4	15	6.5	11	35	18.5	28.5	17	30.7	10
GPHF803		G3/8	G3/8	15	7	12	40	18.5	29.5	19	44.8	5
GPHF804		G1/2	G1/2	15	8.5	13.5	47.5	18.5	32	24	84.7	5
GPHF1002	10	G1/4	G1/4	18	6.5	11	35	21	31	17	32	10
GPHF1003		G3/8	G3/8	18	7	12	40	21	33	19	46.2	5
GPHF1004		G1/2	G1/2	18	8.5	13.5	47.5	21	35.5	24	86.1	5
GPHF1203	12	G3/8	G3/8	21	7	12	40	23	36	19	48.4	5
GPHF1204		G1/2	G1/2	21	8.5	13.5	47.5	23	38	24	89.7	5

### GPKD Series

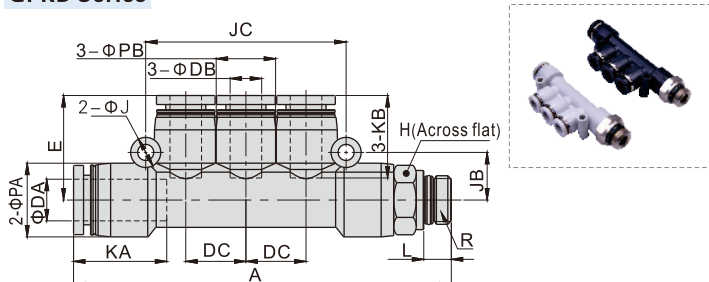

Model/Item	ΦDA	ΦDB	R	L	A	ΦPA	ΦPB	KA	KB
GPKD6-401	6	4	G1/8	5.5	66	12.5	9	16.5	14
GPKD8-602	8	6	G1/4	6.5	77	15	12.5	18.5	16.5
GPKD10-803	10	8	G3/8	7	89.5	18	15	21	18.5
Model/Item	ΦJ	JB	JC	DC	E	H	Weight(g)	PCS/bag	
GPKD6-401	3.2	8	34	10	17.5	12	14.9	2	
GPKD8-602	3.2	9.5	40	12	21	14	24.9	2	
GPKD10-803	4.3	11	48	14.5	24	19	39	2	





## Metal one-touch fittings

### Ordering code

**GBPC 6 01**

① ② ③

① Model		② Port size	③ Thread connection
GBPC: Metal male connector (G thread)	GBPCF: Metal female connector (G thread)	4: $\Phi$ 4mm 6: $\Phi$ 6mm 8: $\Phi$ 8mm 10: $\Phi$ 10mm 12: $\Phi$ 12mm	M5: M5X0.8 01: G1/8 02: G1/4 03: G3/8 04: G1/2
GBPMF: Metal bulkhead female connector (G thread)			

**GBPM 6**

① ②

① Model	② Port size
GBPM: Metal bulkhead connector (G thread)	4: $\Phi$ 4mm 6: $\Phi$ 6mm 8: $\Phi$ 8mm 10: $\Phi$ 10mm 12: $\Phi$ 12mm

### Specification

<b>Operating pressure range</b>	<b>0~9kgf/cm<sup>2</sup>(0~0.9MPa)</b>
Negative pressure	-750mmHg(10Torr)
Proof pressure	1.5MPa
Ambient and fluid temperature (°C)	0~150
Applicable tubing	Soft nylon or polyurethane
Color	Gray/black

Note: The temperature resistance level of the tubing should be confirmed first when used in high temperature environments.

### Product feature

1. High flow capacity; The flow rate of these fittings is equivalent to that of the adaptable tubes.
2. Inserting or removal tubing is simple and convenient, and the connecting portion is reliable and durable.
3. Thread is attached with a sealing gasket, to ensure no leakage of the threaded connection part.
4. The fitting metal body adopts a special nickel-plating process, which has good corrosion resistance.
5. Metal fittings can be used in high temperature environment.

### Table for interface port and tube O.D.

Product series	Thread type	Port size				
		$\Phi$ 4	$\Phi$ 6	$\Phi$ 8	$\Phi$ 10	$\Phi$ 12
GBPC	M5	●	●			
	G1/8	●	●	●	●	
	G1/4	●	●	●	●	●
	G3/8		●	●	●	●
	G1/2				●	●
GBPCF	M5	●	●			
	G1/8	●	●	●		
	G1/4		●	●	●	
	G3/8				●	●
	G1/2					●
GBPMF	M5					
	G1/8	●	●	●		
	G1/4		●	●	●	
	G3/8				●	●
	G1/2					●
Product series		Port size				
GBPM		●	●	●	●	●

### Inner structure

GBPC Series		
NO.	Name	Material
1	Metal connector	Brass
2	Locating ring	Aluminum alloy
3	Spring gasket	Stainless steel
4	Locating seat	Aluminum alloy
5	Special shape O-ring	Viton
6	Straight connector body	Brass
7	O-ring	NBR

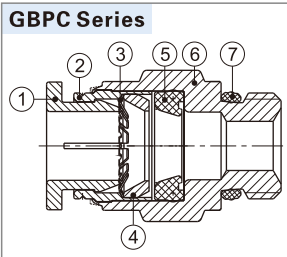

## Metal one-touch fittings

### Dimensions

#### GBPC Series

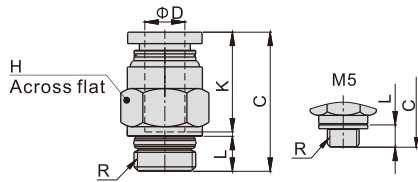

Model/Item	ΦD	R	L	C	K	H	Weight(g)	PCS/bag
GBPC4M5	4	M5X0.8	3.5	19.5	14	9	5.5	10
GBPC401		G1/8	5.5	16.5	13	10	7.9	10
GBPC402	6	G1/4	6.5	17	13	14	8.7	10
GBPC6M5		M5X0.8	3.5	22	16	12	10.1	10
GBPC601	6	G1/8	5.5	21.5	16	12	13.8	10
GBPC602		G1/4	6.5	20.5	16	14	15.1	10
GBPC603	8	G3/8	7	20	16	19	26	10
GBPC801		G1/8	5.5	25.5	18	14	13.3	10
GBPC802	8	G1/4	6.5	24.5	18	14	13.5	10
GBPC803		G3/8	7	21.5	18	19	25.9	10
GBPC1001	10	G1/8	5.5	28.5	20.5	17	17.2	10
GBPC1002		G1/4	6.5	28	20.5	17	19.8	10
GBPC1003	10	G3/8	7	24	20.5	19	32.3	10
GBPC1004		G1/2	8.5	22.5	19.5	22	31.9	10
GBPC1202	12	G1/4	6.5	32.5	22	21	29.4	10
GBPC1203		G3/8	7	30	22	21	29.3	10
GBPC1204	12	G1/2	8.5	27	22	22	37.2	10

#### GBPMF Series

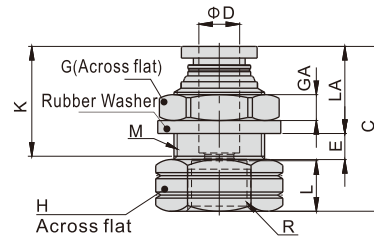

Model/Item	ΦD	R	M	L	C	K	LA	E	GA	G	H	Weight(g)	PCS/bag
GBPMF401	4	G1/8	M12X1	8	25	14	12	4	4	14	14	7.6	10
GBPMF601	6	G1/8	M14X1	8	25	16	12	5	4	17	17	10.4	10
GBPMF602		G1/4	M14X1	11	30	16	12	5	4	17	17	12.2	10
GBPMF801	8	G1/8	M16X1	8	27	18	13	5.5	4	19	19	13.9	10
GBPMF802		G1/4	M16X1	11	31.5	18	13	5.5	4	19	19	15.3	10
GBPMF1002	10	G1/4	M20X1	11	34.5	20.5	14	7.5	5	24	22	26.2	10
GBPMF1003		G3/8	M20X1	12	35.5	20.5	14	7.5	5	24	22	24.4	10
GBPMF1203	12	G3/8	M22X1	12	37	22	15	8	5	27	24	32.6	10
GBPMF1204		G1/2	M22X1	13.5	38.5	22	15	8	5	27	25	31.8	10

#### GBPCF Series

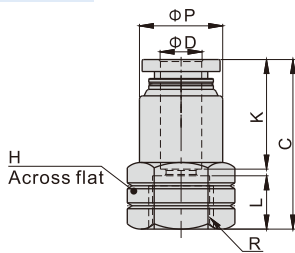

Model/Item	ΦD	R	ΦP	L	C	K	H	Weight(g)	PCS/bag
GBPCF4M5	4	M5X0.8	9	5	21	14	10	3.5	10
GBPCF401		G1/8	9.5	8	23	14	14	5.3	10
GBPCF6M5	6	M5X0.8	12	5	21	16	12	5.6	10
GBPCF601		G1/8	12.5	8	25	16	14	7.2	10
GBPCF602	8	G1/4	12.5	11	28	16	17	9.2	10
GBPCF801		G1/8	14	8	27	18	14	7.1	10
GBPCF802	8	G1/4	14.5	11	30	18	17	10.6	10
GBPCF1002		G1/4	17	11	32.5	20.5	17	13.5	10
GBPCF1003	10	G3/8	18	12	33.5	20.5	21	17.5	10
GBPCF1203		G3/8	21	12	35	22	21	22	10
GBPCF1204	12	G1/2	21	13.5	36.5	22	21	24.9	10

#### GBPM Series

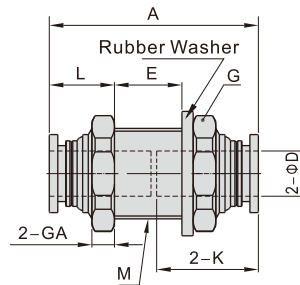

Model/Item	ΦD	M	A	K	L	E	G(Across flat)	GA	Weight(g)	PCS/bag
GBPM4	4	M12X1	28.5	14	10	7	14	4	6.4	10
GBPM6	6	M14X1	33	16	10	11	17	4	16.4	10
GBPM8	8	M16X1	37	18	11	13	19	4	15.8	10
GBPM10	10	M20X1	41.5	20.5	12	16	24	5	28.9	10
GBPM12	12	M22X1	45	22	13	17.5	27	6	40.3	10

## One-touch fittings—threaded type

### Ordering code

GBB 01 01



① Model				② Thread connection I	③ Thread connection II
GBB: Male connector (G thread)	GBD: Male & female connector (G thread) [Note1]	GBU: Double female connector (G thread)	GBZ: Hexagon head cap plug (G thread) [Note2]	01: G1/8 02: G1/4 03: G3/8 04: G1/2	01: G1/8 02: G1/4 03: G3/8 04: G1/2

[Note1] For GBD series, Thread I is Female thread, Thread II is male thread; [Note2] For GBZ series, no thread II and thread I is male thread.

### Specification

Operating pressure range	0~10kgf/cm <sup>2</sup> (0~1.0MPa)
Negative pressure	-750mmHg(10Torr)
Proof pressure	3.0MPa
Ambient and fluid temperature (°C)	0~150

### Configuration table of tubing thread

Product series	Thread connection I	Thread connection II			
		01	02	03	04
GBB	01	●	●	●	●
	02		●	●	●
	03			●	●
	04				●
GBD	01		●	●	●
	02			●	●
	03				●
	04				
GBU	01	●			
	02		●		
	03			●	
	04				●
Product series	Thread connection				
	01	02	03	04	
GBZ	●	●	●	●	

### Product feature

1. Variable models can be widely used in every kind of pneumatic systems.
2. High circulation performance bear the same flow with the volume of the tube inner diameter.
3. The nickel plated body is anti-corrosion and anti-pollution, which allows a broader application.
4. Metal fittings can be used in high temperature environment.

### Dimensions

#### GBB Series

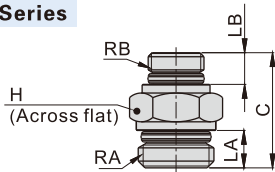

Model\Item	RA	RB	LA	LB	C	H	Weight(g)	PCS/bag
GBB0101	G1/8	G1/8	5.5	5.5	15.5	10	3.2	10
GBB0102	G1/4	G1/8	6.5	5.5	20	14	7.3	10
GBB0103	G3/8	G1/8	7	5.5	21.5	19	15.3	10
GBB0202	G1/4	G1/4	6.5	6.5	21	14	8.4	10
GBB0203	G3/8	G1/4	7	6.5	22.5	19	15.9	10
GBB0204	G1/2	G1/4	8.5	6.5	24.5	22	22.4	10
GBB0303	G3/8	G3/8	7	7	23.5	19	17.8	10
GBB0304	G1/2	G3/8	8.5	7	25	22	23	10
GBB0404	G1/2	G1/2	8.5	8.5	27	22	23.3	10

#### GBD Series

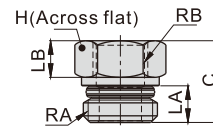

Model\Item	RA	RB	LA	LB	C	H	Weight(g)	PCS/bag
GBD0102	G1/4	G1/8	6.5	8	14.5	14	8.8	10
GBD0103	G3/8	G1/8	7	8	14	19	17.7	10
GBD0104	G1/2	G1/8	8.5	8	16	22	29.5	10
GBD0203	G3/8	G1/4	7	8.5	16	19	16.4	10
GBD0204	G1/2	G1/4	8.5	8.5	16	22	26.3	10
GBD0304	G1/2	G3/8	8.5	9.5	19	22	24.5	10

#### GBU Series

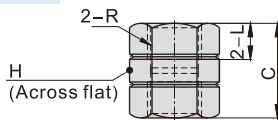

Model\Item	R	L	C	H	Weight(g)	PCS/bag
GBU0101	G1/8	6.5	17	14	8.4	10
GBU0202	G1/4	8.5	23	17	25.4	10
GBU0303	G3/8	9.5	25	21	40	10
GBU0404	G1/2	11	28	25	46.6	10

#### GBZ Series

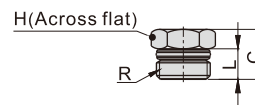

Model\Item	R	L	C	H	Weight(g)	PCS/bag
GBZ01	G1/8	5.5	9	10	3.7	10
GBZ02	G1/4	6.5	12.5	14	9.2	10
GBZ03	G3/8	7	14	19	18	10
GBZ04	G1/2	8.5	16	22	29.4	10



## One-touch fittings—threaded type

### Ordering code

GBKC 06 04 - 01

① ② ③ ④

① Model	② Tubing outer diameter	③ Tubing inner diameter	④ Thread connection
GBKC: Straight locknut connector (G thread) 	04: Φ4mm 06: Φ6mm 08: Φ8mm 10: Φ10mm 12: Φ12mm	25: Φ2.5mm 04: Φ4mm 05: Φ5mm 06: Φ6mm 65: Φ6.5mm 75: Φ7.5mm 08: Φ8mm 09: Φ9mm	M3: M3X0.5 M5: M5X0.8 01: G1/8 02: G1/4 03: G3/8 04: G1/2

Note: When using the tubing Φ8×Φ5.5, the straight lock nut connector of GBKC0806 can be used.

### Specification

Operating pressure range	0~10kgf/cm <sup>2</sup> (0~1.0MPa)
Negative pressure	-750mmHg(10Torr)
Proof pressure	3.0MPa
Ambient and fluid temperature (°C)	0~150

Note: The temperature resistance level of the tubing should be confirmed first when used in high temperature environments.

### Product feature

- Variable models can be widely used in every kind of pneumatic systems.
- High circulation performance bear the same flow with the volume of the tube innerdiameter.
- The nickel plated body is anti-corrosion and anti-pollution, which allows a broader application.
- Metal fittings can be used in high temperature environments.

### Dimensions

#### GBKC Series

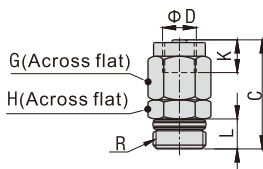

Model/Item	ΦD	R	L	C	K	G	H	Weight (g)	PCS/bag		
	O.D I.D										
GBKC0425-M3	4	2.5	M3×0.5	3	17	5	8	8	4.4	10	
GBKC0425-M5			M5×0.8	3.5	17.5						
GBKC0425-01			G1/8	5.5	18.5						
GBKC0604-01	6	4	G1/8	5.5	20	5.5	10	10	9	10	
GBKC0604-02				G1/4	6.5						23.5
GBKC0604-03				G3/8	7						25
GBKC0805-01	8	5	G1/8	5.5	23.5	6.5	12	12	12.6	10	
GBKC0805-02				G1/4	6.5						25.5
GBKC0805-03				G3/8	7						27
GBKC0806-01	8	5.5	G1/8	5.5	23.5	6.5	12	12	12.9	10	
GBKC0806-02				G1/4	6.5						25.5
GBKC0806-03				G3/8	7						27

Model/Item	ΦD	R	L	C	K	G	H	Weight (g)	PCS/bag		
	O.D I.D										
GBKC1065-02	10	6.5	G1/4	6.5	28	7.5	15	15	23.7	10	
GBKC1065-03				G3/8	7						29.5
GBKC1065-04				G1/2	8.5						32
GBKC1075-02	10	7.5 or 8	G1/4	6.5	28	7.5	15	15	22.5	10	
GBKC1075-03				G3/8	7						29.5
GBKC1075-04				G1/2	8.5						32
GBKC1208-02	12	8	G1/4	6.5	28	7.5	17	17	28.9	10	
GBKC1208-03				G3/8	7						29.5
GBKC1208-04				G1/2	8.5						32
GBKC1209-02	12	9 or 10	G1/4	6.5	28	7.5	17	17	29	10	
GBKC1209-03				G3/8	7						29.5
GBKC1209-04				G1/2	8.5						32

### Installation and application

#### 1. Method of inserting or removal a tubing

##### 1.1 Inserting a tubing

Place the locking cap over the tubing, and insert the tubing into the body, then tighten the locking cap. (As figure 1)

##### 1.2 Removing a tubing

Loosen the locking cap first, then remove the tubing. (As figure 2)

#### 2. Method of tightening the connector thread

Tighten the connector with a hex wrench, as shown right.

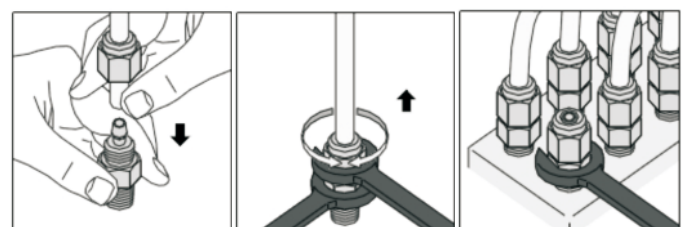

Figure 1

Figure 2

Figure 3

## One-touch fittings—tube-tube type

### Ordering code

Same diameter type fittings

GPE 6 □

① ② ③

① Model				② Port size	③ Standard color		
GPM: Bulkhead union 	GPE: Union tee 	GPP: Plug 	GPV: Union elbow 	4: Φ4mm 6: Φ6mm 8: Φ8mm 10: Φ10mm 12: Φ12mm	Standard color	Specification	Adaptable model
GPLM: Bulkhead male elbow 	GPY: Union "Y" 	GPZ: Cross 	GPU: Straight union 		Blank: Gray	Release button: Gray Body: Gray	GPM Others
					D: Black	Release button: Black Body: Black	GPM Others

Different diameter type fittings

GPEG 6 - 4 □

① ② ③ ④

① Model					② Port size I	③ Port size II	④ Standard color	
GPG: Different diameter straight 	GPZG: Different diameter cross 	GPEW: Different diameter tee 	GPYW: Different diameter union "Y" 	GPGJ: Plug-in reducer 	4: Φ4mm 6: Φ6mm 8: Φ8mm 10: Φ10mm 12: Φ12mm	4: Φ4mm 6: Φ6mm 8: Φ8mm 10: Φ10mm	Standard color	Specification
GPEG: Different diameter tee 	GPKG: Reducer triple branch union 	GPHK: Universal reducer triple branch union 	GPHD: Universal reducer four branch union 				Blank: Gray	Release button: Gray Body: Gray
							D: Black	Release button: Black Body: Black

### Specification

Operating pressure range	0~10kgf/cm <sup>2</sup> (0~1.0MPa)
Negative pressure	-750mmHg(10Torr)
Proof pressure	1.5MPa
Ambient and fluid temperature (°C)	-20~70
Applicable tubing	Soft nylon or polyurethane
Color	Gray/black

### Product feature

- Variable models can be widely used in every kind of pneumatic systems.
- High circulation performance: bear the same flow with the volume of the tubing inside diameter.
- Connect tubing easily and conveniently. The tubing connection portion is safe and durable.
- The threaded portion is covered with sealant and the M5 thread is attached with a sealing gasket to prevent air leakage over the connection thread portion.

### Inner structure

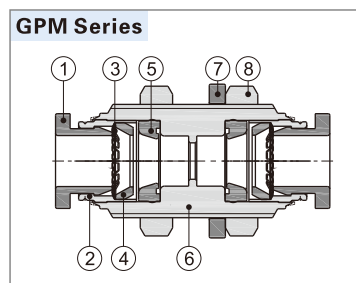

No.	Item	Material
1	Release button	POM
2	Guide	Aluminum alloy
3	Spring gasket	Stainless steel
4	Chuck	POM
5	O-ring	NBR
6	Body	Aluminum alloy
7	Rubber washer	NBR
8	Nut	Aluminum alloy

### Table for interface port and tube O.D.

Product series	Port size I	Port size II			
		Φ4	Φ6	Φ8	Φ10
GPG GPGJ	Φ4				
	Φ6	●			
	Φ8	●	●		
	Φ10		●	●	
	Φ12			●	●
GPEG GPEW GPYW	Φ4				
	Φ6	●			
	Φ8		●		
	Φ10			●	
	Φ12			●	●
GPZG	Φ4				
	Φ6	●			
	Φ8		●		
	Φ10			●	
GPKG	Φ4				●
	Φ6	●			
	Φ8		●		
	Φ10			●	
GPHK GPHD	Φ4				
	Φ6				
	Φ8		●		
	Φ10			●	
Product series	Port size				
	Φ4	Φ6	Φ8	Φ10	Φ12
GPE, GPY, GPV, GPU GPM, GPLM, GPP, GPZ	●	●	●	●	●

# Accessories—One-Touch Fittings

## One-touch fittings—tube-tube type

### Dimensions

#### GPE Series

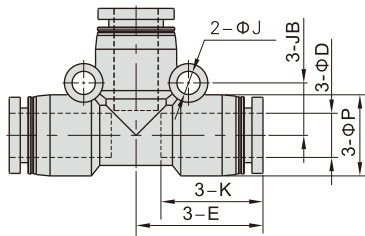

Model\Item	ΦD	ΦP	K	E	ΦJ	JB	Weight(g)	PCS/bag
GPE4	4	9	14	17	3.2	6.5	3.1	10
GPE6	6	12.5	16.5	20	3.2	8	6.1	10
GPE8	8	15	18.5	23	4.3	9.5	8.8	10
GPE10	10	18	21	26.5	4.3	11	13.8	10
GPE12	12	21	23	30	4.3	13	21	10

#### GPU Series

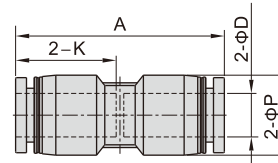

Model\Item	ΦD	ΦP	K	A	Weight(g)	PCS/bag
GPU4	4	9	14	29.5	1.7	10
GPU6	6	12.5	16.5	34	3.6	10
GPU8	8	15	18.5	38.5	5	10
GPU10	10	18	21	43	8.1	10
GPU12	12	21	23	47	12	10

#### GPY Series

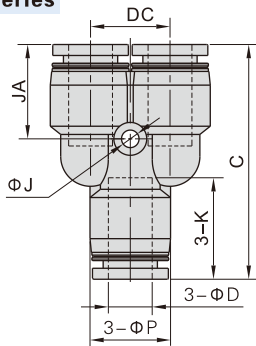

Model\Item	ΦD	ΦP	C	K	ΦJ	JA	DC	Weight(g)	PCS/bag
GPY4	4	9	31.5	14	3.2	13	10	3	10
GPY6	6	12.5	37	16.5	3.2	15.5	12	6	10
GPY8	8	15	42.5	18.5	3.2	17	14.5	8.6	10
GPY10	10	18	48.5	21	4.3	19.5	18	14	10
GPY12	12	21	54.5	23	4.3	21	20.5	21.2	10

#### GPM Series

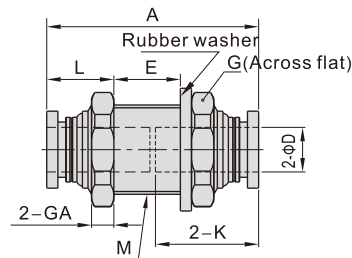

Model\Item	ΦD	M	A	K	L	E	GA	G	Weight(g)	PCS/bag
GPM4	4	M12X1	29	14	10	7	4	14	6.2	10
GPM6	6	M14X1	34	16.5	10.5	11	4	17	9.5	10
GPM8	8	M16X1	38	18.5	11.5	13	4	19	15.7	10
GPM10	10	M20X1	43	21	12.5	16	5	24	22.5	10
GPM12	12	M22X1	46.5	23	13.5	17.5	6	27	29.5	10

#### GPV Series

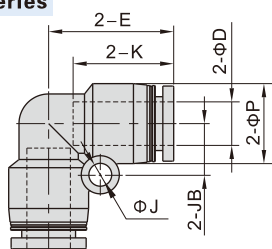

Model\Item	ΦD	ΦP	K	E	ΦJ	JB	Weight(g)	PCS/bag
GPV4	4	9	14	17	3.2	6.5	1.9	10
GPV6	6	12.5	16.5	20	3.2	8	4.2	10
GPV8	8	15	18.5	23	4.3	9.5	6	10
GPV10	10	18	21	26.5	4.3	11	9.3	10
GPV12	12	21	23	30	4.3	13	14.6	10

#### GPLM Series

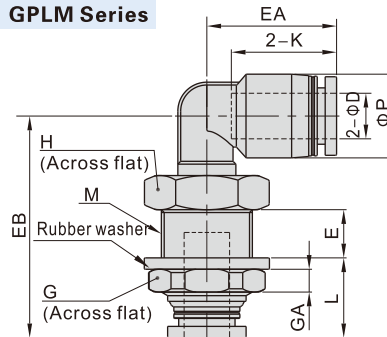

Model\Item	ΦD	ΦP	M	L	E	K	EA	EB	GA	G	H	Weight(g)	PCS/bag
GPLM4	4	9	M12X1	12	7.5	14	17	31	4	14	14	7.5	10
GPLM6	6	12.5	M14X1	12.5	8.5	17	20	35.5	4	17	17	12.1	10
GPLM8	8	15	M16X1	13.5	9	18.5	23	39	4	19	19	16.6	10
GPLM10	10	18	M20X1	14.5	11	21	25.5	44.5	5	24	22	26.2	10
GPLM12	12	21	M22X1	15.5	11	23	29.5	48	6	27	24	34	10

# Accessories—One-Touch Fittings

## One-touch fittings—tube-tube type

### GPYW Series

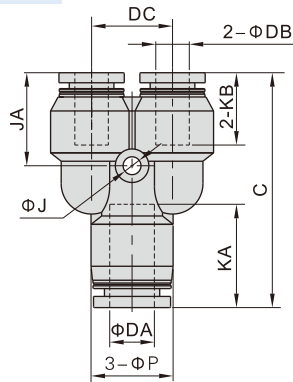

Model\Item	φDA	φDB	C	φP	KA	KB	φJ	JA	DC	Weight(g)	PCS/bag
GPYW6-4	6	4	36.5	12.5	16.5	14	3.2	15	12	5.8	10
GPYW8-6	8	6	42	15	18.5	16.5	3.2	16.5	14.5	9.1	10
GPYW10-8	10	8	48.5	18	21	18.5	4.3	19	18	14.1	10
GPYW12-8	12	8	54	21	23	18.5	4.3	20.5	20.5	22.3	10
GPYW12-10	12	10	54.5	21	23	21	4.3	21	20.5	21.7	10

### GPEG Series

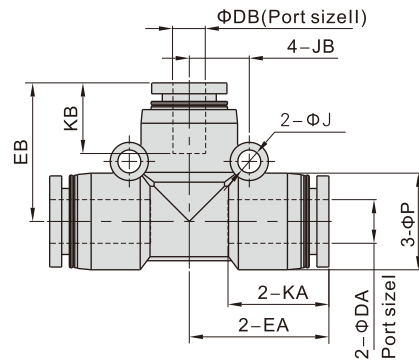

Model\Item	φDA	φDB	φP	KA	KB	EA	EB	φJ	JB	Weight(g)	PCS/bag
GPEG6-4	6	4	12.5	16.5	14	20.0	19.5	3.2	8	7	10
GPEG8-6	8	6	15	18.5	16.5	22.5	22	4.3	9.5	22.8	10
GPEG10-8	10	8	18	21	18.5	25.5	25.5	4.3	11	15.1	10
GPEG12-8	12	8	21	23	18.5	29	28.5	4.3	13	2.2	10
GPEG12-10	12	10	21	23	21	29	29	4.3	13	21.5	10

### GPZ Series

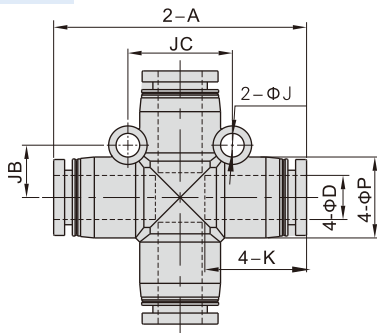

Model\Item	φD	A	φP	K	φJ	JB	JC	Weight(g)	PCS/bag
GPZ4	4	34	9	14	3.2	6.5	13	3.9	10
GPZ6	6	39.5	12.5	16.5	3.2	8	16	7.9	10
GPZ8	8	46	15	18.5	4.3	9.5	19	11.1	10
GPZ10	10	52.5	18	21	4.3	11	22	17.5	10
GPZ12	12	59.5	21	23	4.3	13	26	26.6	10

### GPEW Series

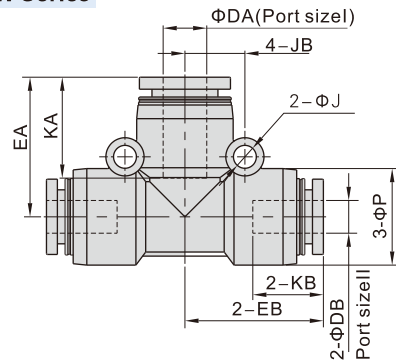

Model\Item	φDA	φDB	φP	KA	KB	EA	EB	φJ	JB	Weight(g)	PCS/bag
GPEW6-4	6	4	12.5	16.5	14	20	19.5	3.2	8	7	10
GPEW8-6	8	6	15	18.5	16.5	22.5	22	4.3	9.5	22.8	10
GPEW10-8	10	8	18	21	18.5	25.5	25.5	4.3	11	15.1	10
GPEW12-8	12	8	21	23	18.5	29	28.5	4.3	13	2.2	10
GPEW12-10	12	10	21	23	21	29	29	4.3	13	21.5	10

### GPG Series

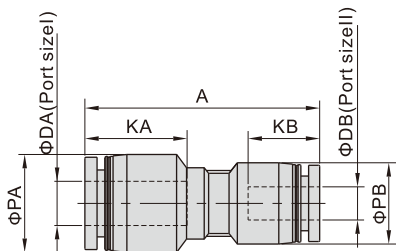

Model\Item	φDA	φDB	φPA	φPB	KA	KB	A	Weight(g)	PCS/bag
GPG6-4	6	4	12.5	9	16.5	14	33.5	2.7	10
GPG8-4	8	4	15	12.5	18.5	14	37.5	4.5	10
GPG8-6	8	6	15	12.5	18.5	16.5	38	4.5	10
GPG10-6	10	6	18	15	21	16.5	42	6.9	10
GPG10-8	10	8	18	15	21	18.5	42.5	6.7	10
GPG12-8	12	8	21	18	23	18.5	46.5	10.3	10
GPG12-10	12	10	21	18	23	21	47	10.2	10

### GPP Series

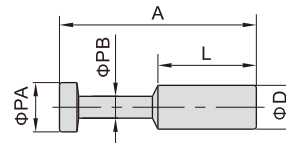

Model\Item	φD	φPA	φPB	L	A	Weight(g)	PCS/bag
GPP4	4	5	3	15	27.5	0.7	10
GPP6	6	7	3	17	32	0.9	10
GPP8	8	9	4	18	36	1.6	10
GPP10	10	11	5	20	42	2.5	10
GPP12	12	13	6	23	44	4.3	10

# Accessories—One-Touch Fittings

## One-touch fittings—tube-tube type

### PGPJ Series

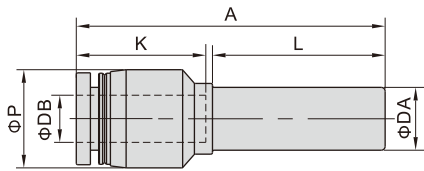

Model\Item	ΦDA	ΦDB	ΦP	K	L	A	Weight(g)	PCS/bag
PGPJ6-4	6	4	9	14	21	35	1.5	10
PGPJ8-4	8	4	12.5	14	22	39	2.6	10
PGPJ8-6	8	6	12.5	16.5	22	39.5	3.2	10
PGPJ10-6	10	6	15	16.5	25	44	4.1	10
PGPJ10-8	10	8	15	18.5	25	44.5	3.9	10
PGPJ12-8	12	8	18	18.5	26	48.5	6.2	10
PGPJ12-10	12	10	18	21	26	49	6	10

### GPZG Series

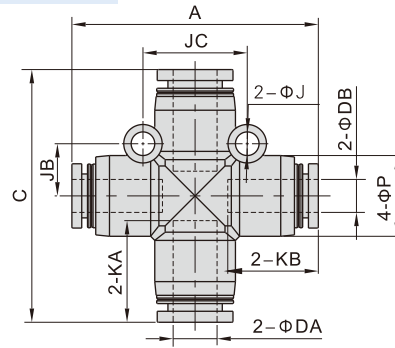

Model\Item	ΦDA	ΦDB	A	C	ΦP	KA	KB	ΦJ	JB	JC	Weight(g)	PCS/bag
GPZG6-4	6	4	39	39.5	12.5	16.5	14	3.2	8	16	8.2	10
GPZG8-6	8	6	45	46	15	18.5	16.5	4.3	9.5	19	12	10
GPZG10-8	10	8	52	52.5	18	21	18.5	4.3	11	22	18.1	10
GPZG12-10	12	10	59	59.5	21	23	21	4.3	13	26	29	10

### GPHK Series

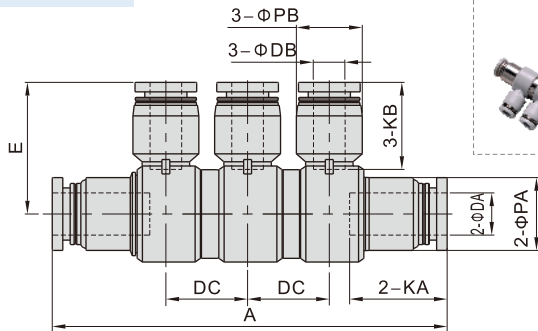

Model\Item	ΦDA	ΦDB	A	ΦPA	ΦPB	KA	KB	DC	E	Weight(g)	PCS/bag
GPHK8-6	8	6	75	14	12.5	18.5	16.5	15.5	25	28.4	2
GPHK10-8	10	8	85.5	17	15	21	18.5	16.5	29.5	45	2

### GPHD Series

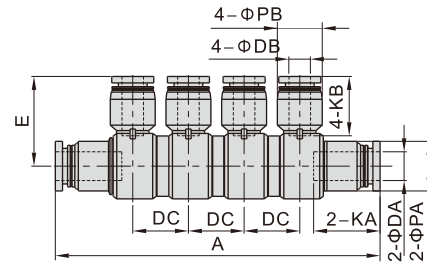

Model\Item	ΦDA	ΦDB	A	ΦPA	ΦPB	KA	KB	DC	E	Weight(g)	PCS/bag
GPHD8-6	8	6	90.5	14	12.5	18.5	16.5	15.5	25	18.7	2
GPHD10-8	10	8	102.5	17	15	21	18.5	16.5	29.5	52.7	2

### GPKG Series

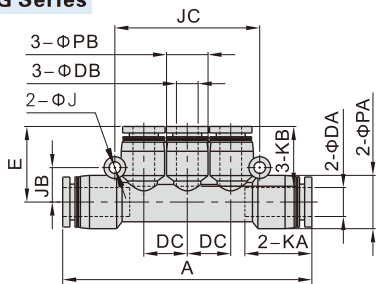

Model\Item	ΦDA	ΦDB	A	ΦPA	ΦPB	KA	KB	ΦJ	JB	JC	DC	E	Weight(g)	PCS/bag
GPKG6-4	6	4	58.5	12.5	9	16.5	14	3.2	8	34	10	17.5	8.6	5
GPKG8-6	8	6	69	15	12.5	18.5	16.5	3.2	9.5	40	12	21	13.5	5
GPKG10-8	10	8	80	18	15	21	18.5	4.3	11	48	14.5	24	20.7	5

## GPSSA, GPSS series

### Ordering code

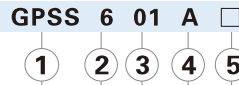

① Model	② Port size	③ Thread connection		④ Control method	⑤ Standard color	
GPSS: Universal speed controller(G thread)	4: Φ4mm 6: Φ6mm 8: Φ8mm 10: Φ10mm 12: Φ12mm	Thread	Adaptable port size	A: Meter-out  Handle marking "A"	Standard color	Specification
		M5: M5X0.8	Φ4	B: Meter-in  Handle marking "B"	Blank: Gray	Release button: Gray Body: Gray
		01: G1/8 02: G1/4 03: G3/8 04: G1/2	Φ4, Φ6 Φ8, Φ10 Φ12		D: Black	Release button: Black Body: Black

### GPSSA 6 □



① Model	② Port size	③ Standard color	
GPSSA: Straight speed controller	4: Φ4mm 6: Φ6mm 8: Φ8mm 10: Φ10mm 12: Φ12mm	Standard color	Specification
		Blank: Gray	Release button: Gray Body: Gray
		D: Black	Release button: Black Body: Black

### Product feature

1. The silencer is small size, and light weight with small installation space.
2. Excellent flow characteristics, high sensitivity and easy to adjust.
3. The silencer brass body adopts a special nickel-plating process, which has good corrosion resistance and anti-pollution property.
4. Anti-drop structure is designed on the regulating rod.
5. The sealant being coated on threaded portion can ensure no leakage of the threaded connection part.
6. The inserting direction of universal speed controller can be adjusted in 360°.

### Specification

<b>Operating pressure range</b>	<b>0~10kgf/cm<sup>2</sup>(0~1.0MPa)</b>
Negative pressure	-750mmHg(10Torr)
Proof pressure	1.5MPa
Ambient and fluid temperature (°C)	-20~70
Applicable tubing	Soft nylon or polyurethane
Color	Gray/black

### Table for interface port and tube O.D.

Product series	Thread type	Port size				
		Φ4	Φ6	Φ8	Φ10	Φ12
GPSSA	-	●	●	●	●	●
	M5	●				
GPSS	G1/8		●	●		
	G1/4		●	●	●	
	G3/8				●	●
	G1/2					●

### Symbol

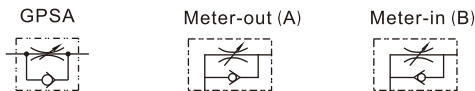

### Inner structure

#### GPSSA Series

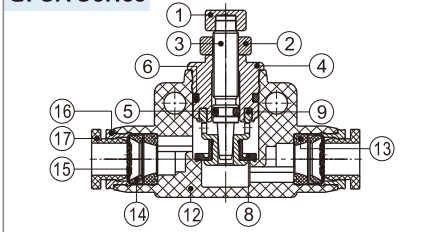

#### GPSS Series

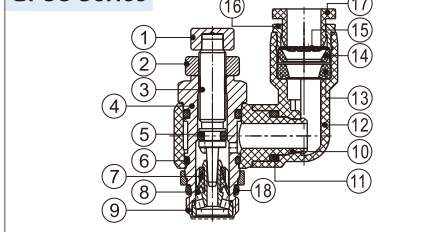

NO.	Name	Material	NO.	Name	Material	NO.	Name	Material
1	Adjusting cap	Aluminum alloy	7	Holder	PBT	13	O-ring	NBR
2	Locking cap	Aluminum alloy	8	O-ring	NBR	14	Locating seat	POM
3	Throttling column	Brass	9	Throttling sleeve	Aluminum alloy/Brass	15	Spring gasket	Stainless steel
4	Throttling body	Brass	10	Plastic body	PBT	16	Locating ring	Aluminum alloy
5	O-ring	NBR	11	O-ring	NBR	17	Plastic interface	POM
6	O-ring	NBR	12	Plastic body	PBT	18	O-ring	NBR

## GPSSA, GPSS series

### Dimensions

#### GPSS Series

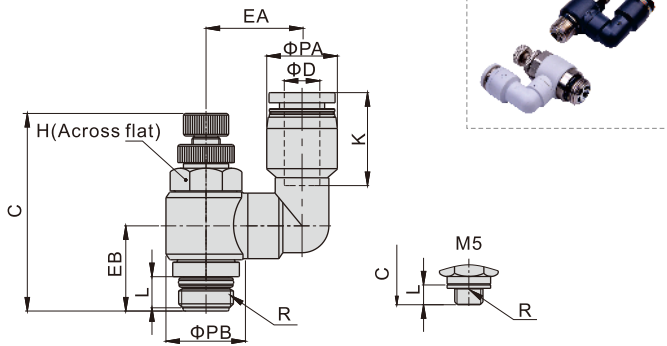

#### GPSSA Series

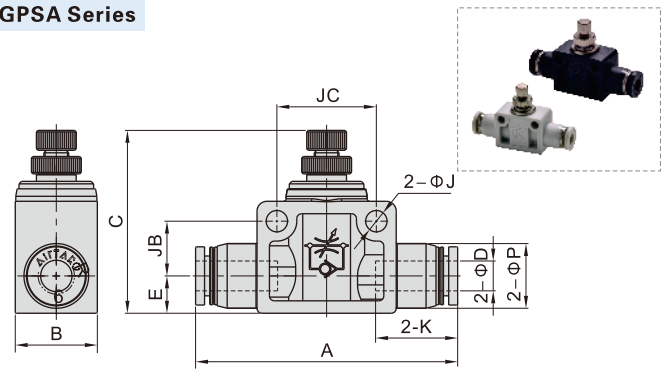

Model/Item [Note1]	ΦD	R	ΦPA	ΦPB	L	C		K	EA	EB	H	Weight (g)	PCS/bag
						max	min						
GPSS4M5□	4	M5×0.8	9	10	3.5	30	27.5	14	12.5	9.5	8	8.1	2
GPSS601□	6	G1/8	12.5	14	5.5	41.5	35	17	17	15	11	19	2
GPSS602□		G1/4	12.5	18	6.5	47.5	41	17	19	17.5	14	34.7	2
GPSS801□	8	G1/8	15	14	5.5	41.5	35	18.5	17	15	11	20.2	2
GPSS802□		G1/4	15	18	6.5	47.5	41	18.5	19	17.5	14	39.8	2
GPSS1002□	10	G1/4	18	18	6.5	47.5	41	21	20.5	17.5	14	37.2	2
GPSS1003□		G3/8	18	22.5	7	52.5	45.5	21	24	20	19	66	2
GPSS1203□		G3/8	21	22.5	7	52.5	45.5	23	25.5	20	19	69.2	2
GPSS1204□	12	G1/2	21	28	8.5	58.5	51.5	23	28	25	24	105.8	2

Model/Item	ΦD	A	B	C		ΦP	E	K	ΦJ	JB	JC	Weight (g)	PCS/bag
				max	min								
GPSSA4	4	41	11	29	26.5	9.5	7	14	3.2	6	14	7.85	2
GPSSA6	6	52.5	16.5	43.5	36.5	13	7.5	16.5	4.3	11	20	18.3	2
GPSSA8	8	59.5	16.5	47	40	15	8.5	18.5	4.3	11	22	23.5	2
GPSSA10	10	69	21	53.5	46.5	18	10.5	21	4.3	14.5	26	42.4	2
GPSSA12	12	78.5	26	58.5	51	21.5	12	23	4.3	17.5	32	67.5	2

[Note1] "□" stands for A or B. A indicates meter-out type while B indicates meter-in type. The two types are with the same overall dimension.

## GPSA, GPSS series

### Flowrate characteristic

#### Controlled flow rate

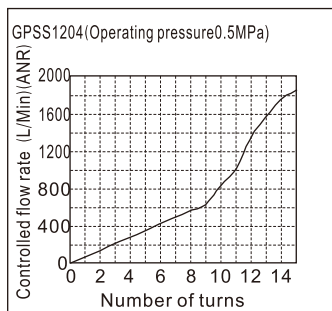
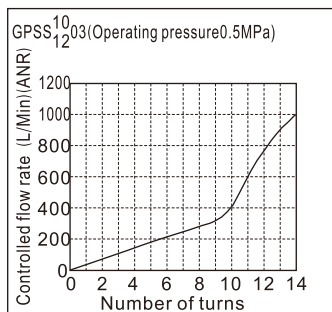
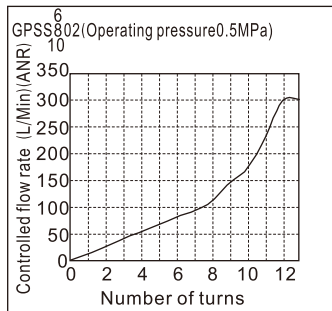
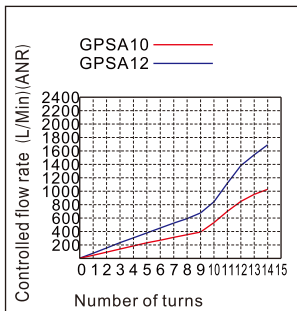
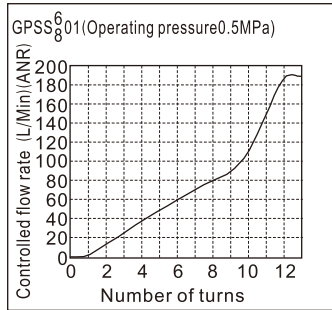
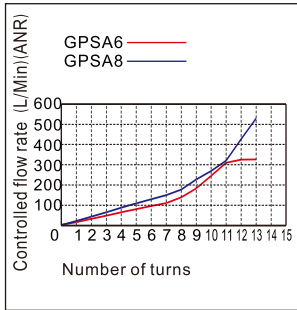
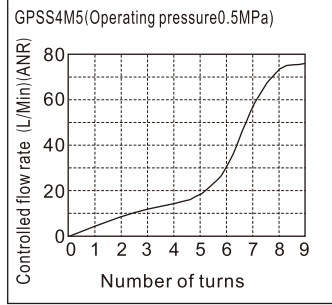
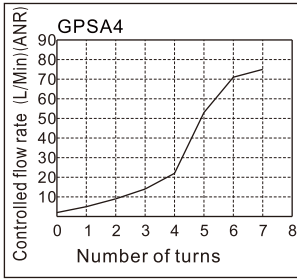

#### Free flow rate

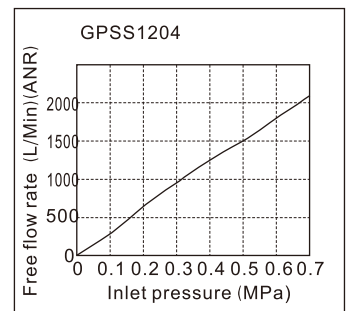
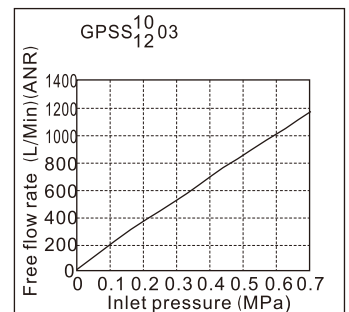
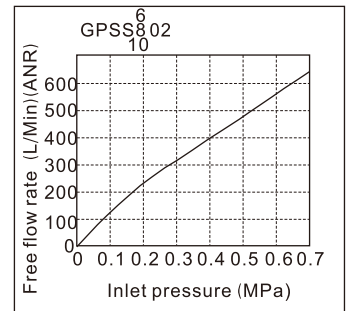
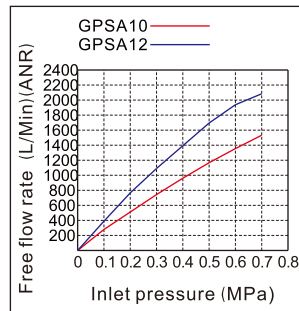
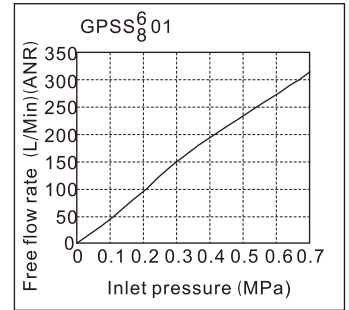
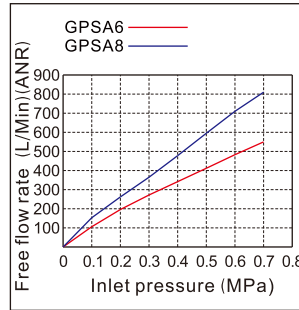
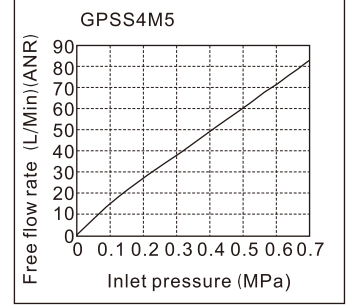
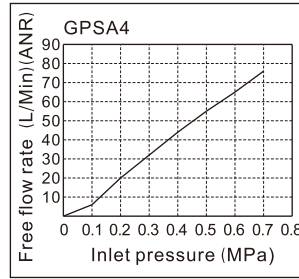



### Selection, Installation and Operation

#### Selection

- The speed controller has meter-out type and meter-in type:

	Working principle	Product identification
<p>Controlled flow Free flow</p>	<b>A: Meter-out</b> 1. The air flow is controlled from the threaded end to tubing connection end. 2. The air flow is free from the tubing connection end to the threaded end.	Handle marking "A" 
<p>Free flow Controlled flow</p>	<b>B: Meter-in</b> 1. The air flow is free from the threaded end to tubing connection end. 2. The air flow is controlled from the tubing connection end to the threaded end.	Handle marking "B" 

- Select the different control method according to the actual requirement. The meter-out type is the first priority.

2.1. The application example of the meter-out speed controller | 2.2. The application example of the meter-in speed controller



#### Installation

- Installation and removal of tubing:

- 1.1. Installation of tubing

Grasp the tubing and slowly push it into the fitting until it comes to a stop. The tubing will be locked by the spring gasket.

- 1.2. Removal of tubing

Push the release button to open the spring gasket so that the tubing can be released.

Note: When remove the tubing, make sure the pressure in the tubing is Zero.

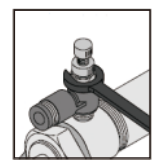
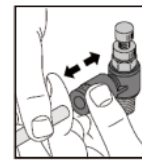
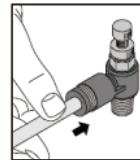

2. Mounting of the speed controller

Mount the speed controller into the inlet and outlet port of the cylinder with a wrench.

Note: Please refer to the fittings for the tightening torque and thread screw-in depth.

#### Operation

1. Adjustment of the cylinder speed

- 1.1. Make sure the speed controller is turned off before applying air pressure. The cylinder may fly out due to the high speed if the air is inlet when the speed controller is turned on.
- 1.2. Adjust the speed by opening the needle slowly from the fully closed state. When a needle valve is turned clockwise, the air flow through is reduced and the actuator speed decreases. When a needle valve is turned counter-clockwise, the air flow through is increased and the actuator speed increases.

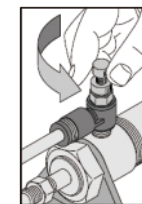
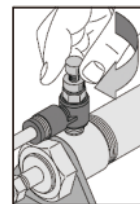

2. Operation of the speed controller

- 2.1. Do not use tools such as pliers to rotate the handle. Do not apply excessive force or shock when the needle is at the place of top or bottom. It can cause damage or air leakage.
- 2.2. A certain amount of leakage is allowed in the closed state of the speed controller. It is not designed for the use as stop valve with zero air leakage.

## GPTL Mini series

### Ordering code

GPTL 6 M5 A □ -M

① ② ③ ④ ⑤ ⑥

① Model	② Port size	③ Thread connection	④ Control method	⑤ Standard color		⑥ Style
GPTL: Speed controller (Push lock) (G Thread)  	4: Φ4mm 6: Φ6mm	M5: M5X0.8 01: G1/8	A: Meter-out 	Standard color	Specification	M: Mini type
			B: Meter-in 	Blank: Gray	Release button: Gray Body: Gray	
				D: Black	Release button: Black Body: Black	

### Specification

<b>Operating pressure range</b>	<b>0~10kgf/cm<sup>2</sup>(0~1.0MPa)</b>
Negative pressure	-750mmHg(10Torr)
Proof pressure	1.5MPa
Ambient and fluid temperature (°C)	-20~70
Applicable tubing	Soft nylon or polyurethane
Color	Gray/black

### Product feature

1. Compare with standard speed controller, smaller size, lighter weight, suitable for more occasions.
2. Effectively control the action speed and the pressure signal transmission from pneumatic device.
3. Simple push-lock, operation.
4. Adjust quickly, easily and accurately.
5. Excellent flow rate characteristic, high sensitivity and easy to adjust.
6. Options of Meter-out and meter-in, applicable for every type actuator.
7. Effectively prevent from corrosion and pollution by nickel plated copper.

### Symbol



### Table for interface port and tube O.D.

Product series	Thread type	Port size	
		Φ4	Φ6
GPTL	M5	●	●
	G1/8	●	●

### Selection, Installation and Operation

1. The rotation torque of the push-lock speed controller cap should not be too large to avoid damage.  
It is recommended to use the torque below.

Thread size	Recommended torque(N.m)
M5	0.05
G1/8	0.08

2. Push-lock speed controller installation instructions is the same as general one. Please refer to general type for specific content.

### Dimensions

#### GPTL Mini series

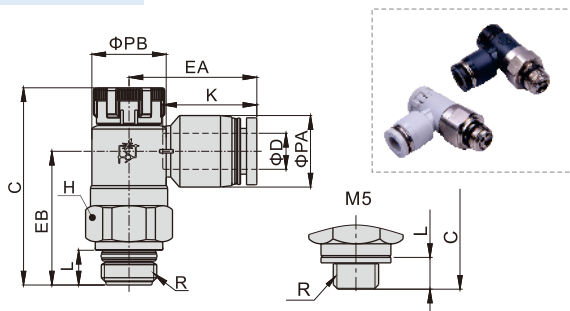

Model/Item [Note1]	ΦD	R	ΦPA	ΦPB	L	C		K	EA	EB	H	Weight (g)	PCS/bag
						Pull	Push						
GPTL4M5□-M	4	M5×0.8	8.5	9	3.5	29.5	28	12.5	16.5	19	9	5	2
GPTL401□-M													
GPTL6M5□-M	6	M5×0.8	10.5	9	3.5	29.5	28	13.5	19.5	19	9	6.2	2
GPTL601□-M													



[Note1] "□" stands for A or B. A indicates meter-out type while B indicates meter-in type. The two types are with the same overall dimension.

## GPTL series

### Ordering code

GPTL 6 01 A □

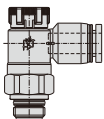
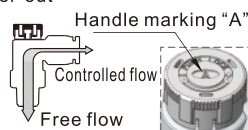
① ② ③ ④ ⑤

① Model	② Port size	③ Thread connection	④ Control method	⑤ Standard color	
GPTL: Speed controller (Push lock) (G Thread) 	6: Φ6mm	01: G1/8 02: G1/4 03: G3/8	A: Meter-out 	Standard color	Specification
	8: Φ8mm	01: G1/8      02: G1/4 03: G3/8      04: G1/2		Blank: Gray	Release button: Gray Body: Gray
	10: Φ10mm	02: G1/4 03: G3/8 04: G1/2	B: Meter-in 	D: Black	Release button: Black Body: Black
	12: Φ12mm	03: G3/8 04: G1/2			

### Specification

<b>Operating pressure range</b>	<b>0~10kgf/cm<sup>2</sup>(0~1.0MPa)</b>
Negative pressure	-750mmHg(10Torr)
Proof pressure	1.5MPa
Ambient and fluid temperature (°C)	-20~70
Applicable tubing	Soft nylon or polyurethane
Color	Gray/black

### Product feature

1. Compare with standard speed controller, smaller size, lighter weight, suitable for more occasions.
2. Effectively control the action speed and the pressure signal transmission from pneumatic device.
3. Simple push-lock, operation.
4. Adjust quickly, easily and accurately.
5. Excellent flow rate characteristic, high sensitivity and easy to adjust.
6. Options of Meter-out and meter-in, applicable for every type actuator.
7. Effectively prevent from corrosion and pollution by nickel plated copper.

### Symbol



### Table for interface port and tube O.D.

Product series	Thread type	Port size			
		Φ6	Φ8	Φ10	Φ12
GPTL	G1/8	●	●		
	G1/4	●	●	●	
	G3/8	●	●	●	●
	G1/2		●	●	●

### Selection, Installation and Operation

1. The rotation torque of the push-lock speed controller cap should not be too large to avoid damage. It is recommended to use the torque below.

Thread size	Recommended torque(N.m)
G1/8	0.08
G1/4	0.16
G3/8	0.24
G1/2	0.32

2. Push-lock speed controller installation instructions is the same as general one. Please refer to general type for specific content.

### Inner structure

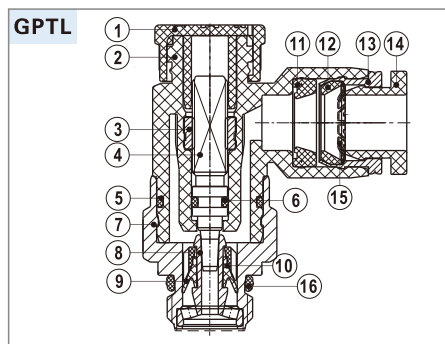

NO.	Name	Material	NO.	Name	Material
1	Adjusting cap	POM	9	Holder	PBT
2	Plastic body	PBT	10	O-ring	NBR
3	Locating ring	Aluminum alloy	11	O-ring	NBR
4	Throttling column	Aluminum alloy	12	Locating seat	POM
5	O-ring	NBR	13	Locating ring	Aluminum alloy
6	O-ring	NBR	14	Plastic interface	POM
7	Throttling body	Brass	15	Spring gasket	Stainless steel
8	Throttling sleeve	Aluminum alloy	16	O-ring	NBR

## GPTL series

### Dimensions

#### GPTL Series

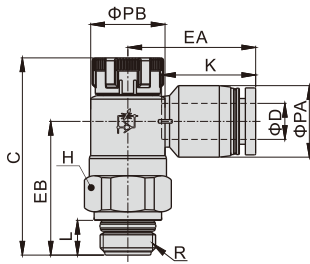

Model\Item [Note1]	ΦD	R	ΦPA	ΦPB	L	C		K	EA	EB	H	Weight (g)	PCS/bag
						Pull	Push						
GPTL601□	6	G1/8	12.5	13	5.5	36	34.5	16.5	22.5	23.5	14	12.5	2
GPTL602□		G1/4	12.5	16.5	6.5	40.5	39	16.5	24	28	17	19.5	2
GPTL603□		G3/8	12.5	19	7	44	42.5	16.5	25.5	31	19	28.5	2
GPTL801□	8	G1/8	15	13	5.5	36	34.5	18.5	24.5	22.5	14	13	2
GPTL802□		G1/4	15	16.5	6.5	40.5	39	18.5	26	27	17	20.5	2
GPTL803□		G3/8	15	19	7	44	42.5	18.5	27	30	19	29	2
GPTL804□	10	G1/2	15	24	8.5	52.5	51	18.5	29.5	37.5	24	49	2
GPTL1002□		G1/4	18	16.5	6.5	40.5	39	21	31	26	17	22	2
GPTL1003□		G3/8	18	19	7	44	42.5	21	29	29	19	30.5	2
GPTL1004□	12	G1/2	18	24	8.5	52.5	51	21	31.5	36.5	24	50.5	2
GPTL1203□		G3/8	21	19	7	44	42.5	23	34.5	28	19	32.5	2
GPTL1204□		G1/2	21	24	8.5	52.5	51	23	34	28	24	53	2

[Note1] "□" stands for A or B. A indicates meter-out type while B indicates meter-in type. The two types are with the same overall dimension.

### Flowrate characteristic

#### Controlled flow rate

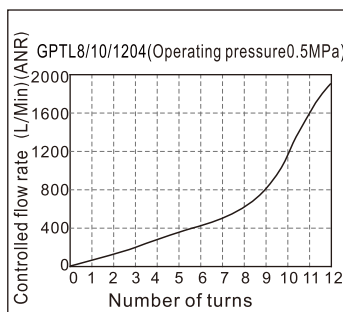
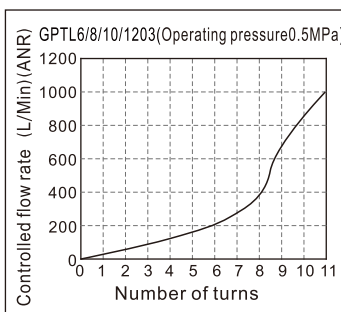
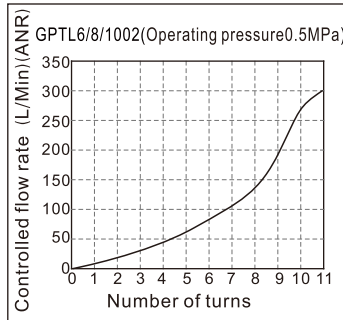
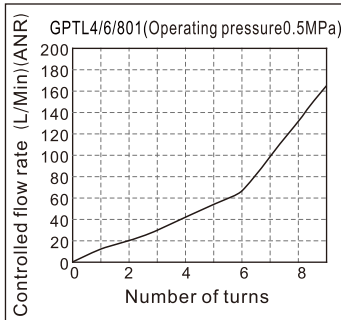
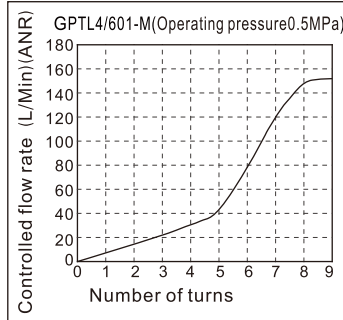
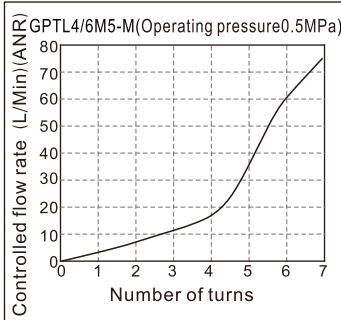

#### Free flow rate

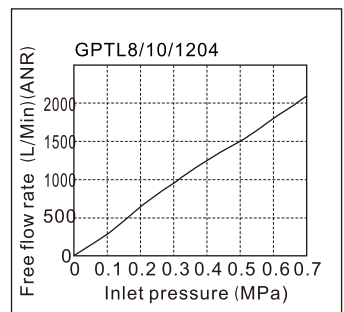
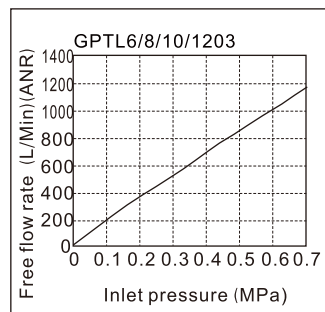
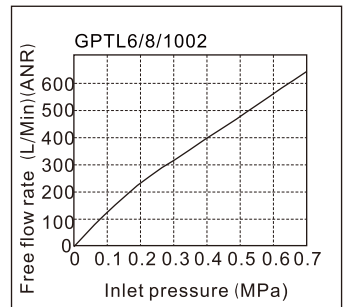
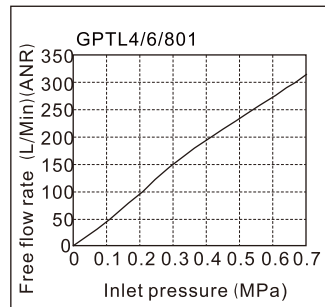
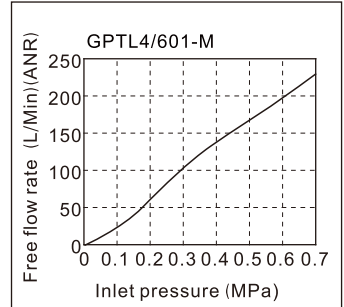
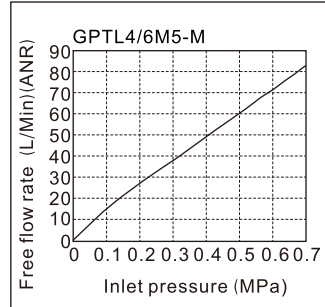

## GPHV series



### Specification

Model	GPHV6	GPHV8	GPHV10	GPHV12
Operating pressure range	0~10kgf/cm <sup>2</sup> (0~1.0MPa)			
Negative pressure	-750mmHg(10Torr)			
Proof pressure	1.5MPa			
Ambient and fluid temperature (°C)	-20~70			
Applicable tubing	Soft nylon or polyurethane			
Color	Gray/black			

### Symbol



### Product feature

1. GPHV series product doesn't contain brass, so can be used for forbidding brass condition.
2. When the three-way valve is closed, the outlet pressure is released, which facilitates in commissioning and maintenance.
3. The finger valve has excellent flow characteristic and high sensitive anti-direction characteristic.

### Ordering code

GPHV 6 A □



① Fitting type	② Port size	③ Valve specification		④ Standard color
GPHV: Finger valve	6: Φ6mm	A: Three-way Knob identifier "A"	B: Two-way Knob identifier "B"	Blank: Gray(Release button: Gray Body: Gray) D: Black(Release button: Black Body: Black)
	8: Φ8mm			
	10: Φ10mm			
	12: Φ12mm			

### Diagram of finger valve in the open and closed states

#### Closed state

Valve is closed, when the angle between the arrow on knob and the arrow on valve body is 90 degree

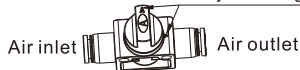

#### Opened state

Valve is open, when the direction of the arrow on commutation knob is consistent with that on valve body.

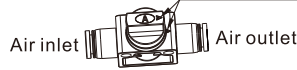

When the three-way valve is closed, the outlet pressure is released, which facilitates in commissioning and maintenance. (as figure below)

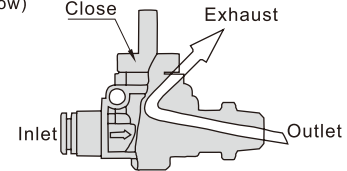

### Inner structure

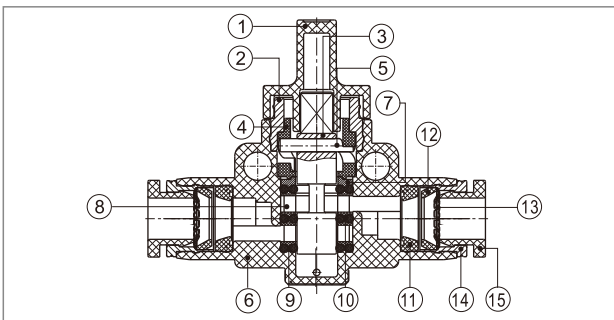

NO.	Name	Material	NO.	Name	Material
1	Knob	POM	9	Special shape O-ring	NBR
2	Fixing ring	Aluminum alloy	10	Spacer ring	Aluminum alloy
3	Spool	Aluminum alloy	11	Special shape O-ring	NBR
4	Cam groove block	POM	12	Locating seat	POM
5	Pin	Stainless steel	13	Spring gasket	Stainless steel
6	Plastic body	PBT	14	Locating ring	Aluminum alloy
7	Locating block	Aluminum alloy	15	Plastic interface	POM
8	Spacer	POM			

### Dimensions

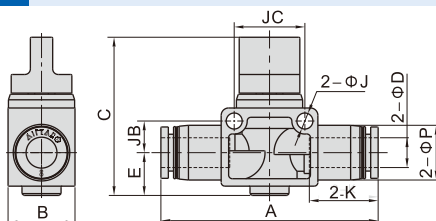

Model\Item	ΦD	A	B	C	ΦP	K	E	ΦJ	JB	JC	Weight(g)	PCS/bag
GPHV6□	6	51.5	17	40.5	12.5	16.5	10	4.3	8	18	14.3	2
GPHV8□	8	58.5	18	42.5	15	18.5	11.5	4.3	8.5	19	17.5	2
GPHV10□	10	66	21	42	18	21	11	4.3	11	24	25.1	2
GPHV12□	12	71	22	46	21	23	13	4.3	11	24	31.4	2

Note: "□" indicates "A" or "B", "A" indicates three-way, and "B" indicates two-way.

The two kinds of valve have same dimensions.

## GBSL, GBSLM, GBESL series

### Ordering code

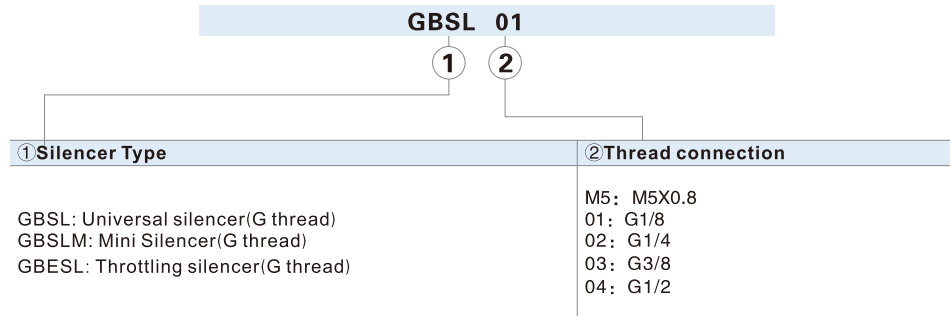

### Product feature

1. This silencers have excellent noise silencing performance.
2. The installation of the silencer is simple and convenient, and the connecting portion is reliable and durable.
3. It is easy to adjust the exhaust flow of the throttling type silencer.

### Configuration table of tubing thread

Product series	Thread connection				
	M5	01	02	03	04
GBSL	●	●	●	●	●
GBSLM	●	●	●	●	●
GBESL		●	●	●	●

### Specification

Model	GBSLM5	GBSL01	GBSL02	GBSL03	GBSL04	GBSLMM5	GBSLM01	GBSLM02	GBSLM03	GBSLM04
Thread connection	M5×0.8	G1/8	G1/4	G3/8	G1/2	M5×0.8	G1/8	G1/4	G3/8	G1/2
Silencing effect(dB)(0.5MPa)	15	20	20	20	12	15	20	20	20	20
Model	GBESL01	GBESL02	GBESL03	GBESL04						
Thread connection	G1/8	G1/4	G3/8	G1/2						
Silencing effect(dB)(0.5MPa)	20	20	20	20						
Operating pressure	0~10kgf/cm <sup>2</sup> (0~1.0MPa)									
Negative pressure	-750mmHg(10Torr)									
Proof pressure	1.5MPa									
Temperature range	-20~70℃									

### Inner structure

#### GBSL Series

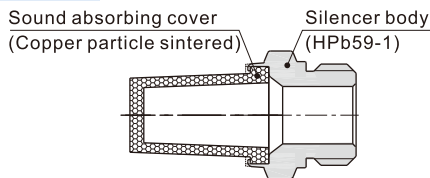

#### GBESL Series

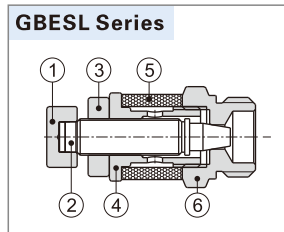

NO.	Name	Material
1	Adjusting cap	Aluminum alloy
2	Throttling column	Aluminum alloy
3	Locking cap	Aluminum alloy
4	Locking ring	Aluminum alloy
5	Silencer ring	Copper particle sintered
6	Silencer body	Brass

### Flowrate characteristic

#### GBSL Series

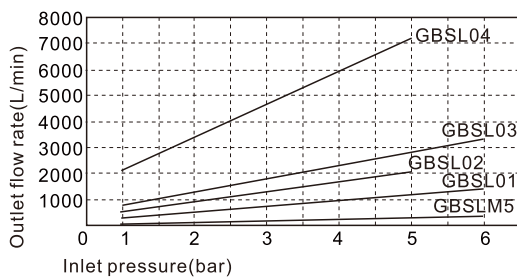

#### GBSLM Series

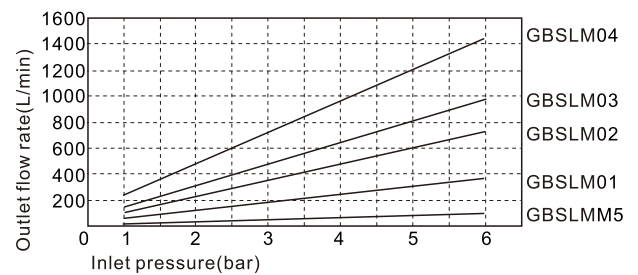

# Accessories—Silencers

## GBSL, GBSLM, GBESL series

### Flowrate characteristic

**GBESL Series** (Inlet pressure and outlet flow rate)

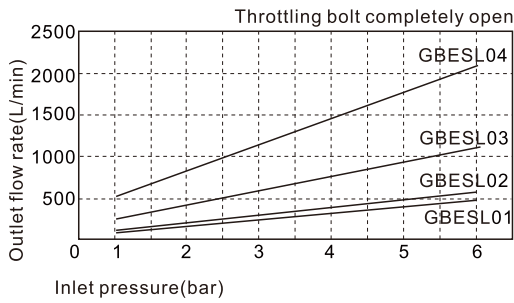

**GBESL Series**

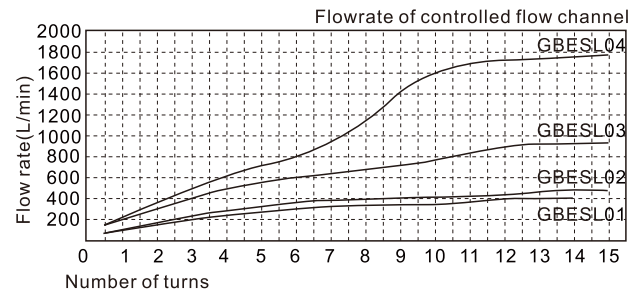

### Dimensions

**GBSL Series**

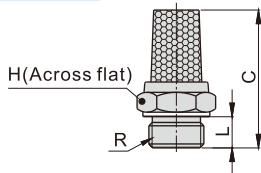

Model/Item	R	L	C	H	Weight(g)	PCS/bag
GBSLM5	M5×0.8	3.5	19.5	8	2.9	10
GBSL01	G1/8	5.5	24	12	6.8	10
GBSL02	G1/4	6.5	29.5	15	11.3	10
GBSL03	G3/8	7	37.5	19	21.1	10
GBSL04	G1/2	8.5	45	22	33.6	10

**GBSLM Series**

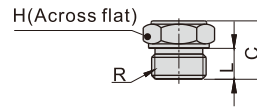

Model/Item	R	L	C	H	Weight(g)	PCS/bag
GBSLMM5	M5×0.8	3.5	9.5	8	2.3	10
GBSLM01	G1/8	5.5	11	11	4.4	10
GBSLM02	G1/4	6.5	13	15	8.1	10
GBSLM03	G3/8	7	14.5	19	14.9	10
GBSLM04	G1/2	8.5	17.5	22	24.5	10

**GBESL Series**

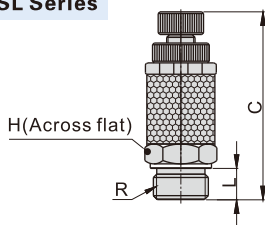

Model/Item	R	L	C		H	Weight(g)	PCS/bag
			max	min			
GBESL01	G1/8	5.5	40.5	33	12	10.1	10
GBESL02	G1/4	6.5	42	34.5	14	17.9	10
GBESL03	G3/8	7	48	40.5	17	30.3	10
GBESL04	G1/2	8.5	58.5	51	24	68.6	10

# Polyurethane re-coil hosepart



## US98A, UE95A Series

### Product feature



1. Plastic polyurethane material conforms to the ROHS environment protection requirement.
2. High elasticity: small bend radius enables PU tube to pass through the tight space.
3. Anti-knot: better anti-knot effect than other plastic tube.
4. Excellent flexibility: it can bear repeated expansion.
5. Anti-abrasion: long working life and suitable for the environment in which it is easy to be worn.
6. Low permeability of gas: relieve the problems of leakage and pollution.
7. Good anti-solubility: no solvent leaks, therefore it will not pollute the environment.
8. Low compression: maintain excellent physical character.
9. Wide resistance: it has certain resistance to chemicals, water, fuel, oil and bacterium.

### Specification(Standard pressure type)

Type [Note1]	Tube OD (mm)	Tube ID (mm)	Wall Thickness (mm)	Package Length(m)	Working Pressure at 23°C(MPa)[Note2]	Burst pressure at 23°C(MPa)	Bend radius (mm)	Weight per 100M(kg)	Temperature (°C)
US98A032020□□	3.2	2.0	0.60	100/200	1.0	3.0	8	0.60	-20~70
US98A040025□□	4.0	2.5	0.75	100/200	1.0	3.0	10	0.94	
US98A060040□□	6.0	4.0	1.00	100/200	1.0	3.0	15	1.93	
US98A080050□□	8.0	5.0	1.50	100	1.0	3.0	20	3.66	
US98A100065□□	10.0	6.5	1.75	100	1.0	3.0	25	5.44	
US98A120080□□	12.0	8.0	2.00	100	1.0	3.0	35	7.56	
US98A160110□□	16.0	11.0	2.50	100	1.0	3.0	80	10.03	
UE95A032020□□	3.2	2.0	0.60	20/100/200	1.0	2.5	8	0.60	-40~70
UE95A040025□□	4.0	2.5	0.75	20/100/200	1.0	2.5	8	0.94	
UE95A060040□□	6.0	4.0	1.00	20/100/200	1.0	2.5	12	1.91	
UE95A080050□□	8.0	5.0	1.50	20/100	1.0	2.5	17	3.58	
UE95A100065□□	10.0	6.5	1.75	20/100	1.0	2.5	20	5.32	
UE95A120080□□	12.0	8.0	2.00	20/100	1.0	2.5	30	7.27	

[Note1] The first square of "□□" in the type column is for ordering code "unit" and the second is for "color".

[Note2] Working pressure:3 to 1 safety factor.

### Specification(Lower pressure type)

Type [Note1]	Tube OD (mm)	Tube ID (mm)	Wall Thickness (mm)	Package Length(m)	Working Pressure at 23°C(MPa)[Note2]	Burst pressure at 23°C(MPa)	Bend radius (mm)	Weight per 100M(kg)	Temperature (°C)
US98A080055□□	8.0	5.5	1.25	100	0.8	2.0	20	3.25	-20~70
US98A080060□□	8.0	6.0	1.00	100	0.4	1.5	25	2.70	
US98A100080□□	10.0	8.0	1.00	100	0.4	1.5	40	3.47	
US98A120100□□	12.0	10.0	1.00	100	0.4	1.5	60	4.24	
US98A160120□□	16.0	12.0	2.00	100	0.4	2.0	80	8.32	
UE95A080055□□	8.0	5.5	1.25	20/100	0.8	1.5	17	3.18	-40~70

[Note1] The first square of "□□" in the type column is for ordering code "unit" and the second is for "color".

[Note2] Working pressure:3 to 1 safety factor.

### Ordering code

#### US98A 060 040 100M BU



① Model	② Tube OD	③ Tube ID	④ Material length	⑤ Standard color [Note1]
US98A: Ester Base, Shore A98±2	032: Φ3.2mm 040: Φ4.0mm 060: Φ6.0mm	020: Φ2.0mm 025: Φ2.5mm 040: Φ4.0mm	065: Φ6.5mm 080: Φ8.0mm 0100: Φ10.0mm 0110: Φ11.0mm 0120: Φ12.0mm	BU: Blue BK: Black GE: Orange C: Clear WH: White CB: Clear Blue R: Red Y: Yellow GA: Gray GN: Green BR: Brown CR: Clear Red CG: Clear Green CY: Clear Yellow CE: Clear Orange
	080: Φ8.0mm 100: Φ10.0mm 120: Φ12.0mm 160: Φ16.0mm	050: Φ5.0mm 055: Φ5.5mm 060: Φ6.0mm	100M: 100 m/coil 200M: 200 m/coil	
UE95A: Ether Base, Shore A95±2	032: Φ3.2mm 040: Φ4.0mm 060: Φ6.0mm	020: Φ2.0mm 025: Φ2.5mm 040: Φ4.0mm	055: Φ5.5mm 065: Φ6.5mm 080: Φ8.0mm	BU: Blue BK: Black GE: Orange C: Clear WH: White CB: Clear Blue R: Red Y: Yellow GA: Gray GN: Green BR: Brown CR: Clear Red CG: Clear Green CY: Clear Yellow CE: Clear Orange
	080: Φ8.0mm 100: Φ10.0mm 120: Φ12.0mm	050: Φ5.0mm	20M: 20 m/coil 100M: 100 m/coil 200M: 200 m/coil	

[Note1] Φ8xΦ6, Φ10xΦ8, Φ12xΦ10 type have nine standard colors: Blue\ Black\ Orange\ Clear\ White\ Clear Blue\ Red\ Yellow\ Gray.





# Polyurethane re-coil hosepart

## UCS Series



### Product feature

1. Plastic polyurethane material conforms to the ROHS environment protection requirement.
2. High elasticity: small bend radius enables PU tube to pass through the tight space.
3. Anti-knot: better anti-knot effect than other plastic tube.
4. Excellent flexibility: it can bear repeated expansion.
5. Anti-abrasion: long working life and suitable for the environment in which it is easy to be worn.
6. Low permeability of gas: relieve the problems of leakage and pollution.
7. Good anti-solubility: no solvent leaks, therefore it will not pollute the environment.
8. Low compression: maintain excellent physical character.
9. Wide resistance: it has certain resistance to chemicals, water, fuel, oil and bacterium.

### Technical chart

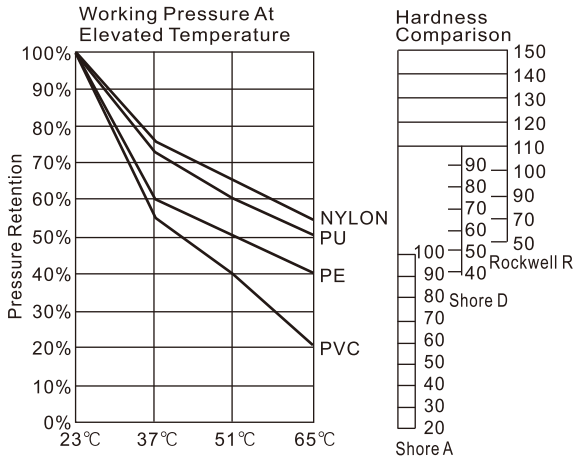

### Specification (Standard pressure type)

Type [Note1]	Tube OD (mm)	Tube ID (mm)	Working Pressure at 23°C (MPa) [Note2]	Burst pressure at 23°C (MPa)	Bend radius (mm)	Length (m) [Note3]	Temp. (°C)
UCS060040□030□□	6.0	4.0	1.0	3.0	38	3	-20~70
UCS060040□060□□	6.0	4.0	1.0	3.0	38	6	
UCS060040□090□□	6.0	4.0	1.0	3.0	38	9	
UCS060040□120□□	6.0	4.0	1.0	3.0	38	12	
UCS060040□150□□	6.0	4.0	1.0	3.0	38	15	
UCS080050□060□□	8.0	5.0	1.0	3.0	38	6	
UCS080050□090□□	8.0	5.0	1.0	3.0	38	9	
UCS080050□120□□	8.0	5.0	1.0	3.0	38	12	
UCS080050□150□□	8.0	5.0	1.0	3.0	38	15	
UCS100065□060□□	10.0	6.5	1.0	3.0	50	6	
UCS100065□090□□	10.0	6.5	1.0	3.0	50	9	
UCS100065□120□□	10.0	6.5	1.0	3.0	50	12	
UCS100065□150□□	10.0	6.5	1.0	3.0	50	15	
UCS120080□060□□	12.0	8.0	1.0	3.0	60	6	
UCS120080□090□□	12.0	8.0	1.0	3.0	60	9	
UCS120080□120□□	12.0	8.0	1.0	3.0	60	12	
UCS120080□150□□	12.0	8.0	1.0	3.0	60	15	

### Specification (Lower pressure type)

Type [Note1]	Tube OD (mm)	Tube ID (mm)	Working Pressure at 23°C (MPa) [Note2]	Burst pressure at 23°C (MPa)	Bend radius (mm)	Length (m) [Note3]	Temp. (°C)
UCS080055□060□□	8.0	5.5	0.8	2.0	38	6	-20~70
UCS080055□090□□	8.0	5.5	0.8	2.0	38	9	
UCS080055□120□□	8.0	5.5	0.8	2.0	38	12	
UCS080055□150□□	8.0	5.5	0.8	2.0	38	15	

[Note1] "□" in the type column is for "color", and "□□" is for "coupling type" and "coupling mode".

[Note2] Working pressure: 3 to 1 safety factor.

[Note3] Material length: length of operating status=(0.8~0.9)xMaterial length.

### Ordering code

UCS 080 050 BU 090M A 1



① Model	② Tube OD	③ Tube ID	④ Standard color	⑤ Material length	⑥ Coupling type	⑦ Coupling form
UCS: Ester Base	060: Φ6.0mm	040: Φ4.0mm	BU: Blue BK: Black GE: Orange C: Clear WH: White CB: Clear Blue R: Red Y: Yellow GN: Green BR: Brown CR: Clear Red CG: Clear Green CY: Clear Yellow CE: Clear Orange	030M: 3m 060M: 6m 090M: 9m 120M: 12m 150M: 15m	A: one end is 30cm and the other end is 10cm	1: Without coupling
	080: Φ8.0mm	050: Φ5.0mm			B: Both of the tubes of the couplings are 10cm	2: With female-male coupling
	100: Φ10.0mm	055: Φ5.5mm			C: Both of the tubes of the couplings are 0cm	3: With male-male coupling
	120: Φ12.0mm	065: Φ6.5mm				
		080: Φ8.0mm				

### Pipe end coupling

Male quick coupling PP40 Φ12 × Φ8	Female quick coupling SP40 Φ12 × Φ8	Male quick coupling PP30 Φ10 × Φ6.5	Female quick coupling SP30 Φ10 × Φ6.5	Male quick coupling PP20 Φ8 × Φ5	Female quick coupling SP20 Φ8 × Φ5	Male quick coupling PP10 Φ6 × Φ4	Female quick coupling SP10 Φ6 × Φ4

PP40/SP40-PU tube (12 × 8) quick coupling use | PP30/SP30-PU tube (10 × 6.5) quick coupling use | PP20/SP20-PU tube (8 × 5) quick coupling use | PP10/SP10-PU tube (6 × 4) quick coupling use

### Product feature

1. Monolayer tube with flame resistant.
2. Excel in elasticity: can pass compactness space with lesser bend radius.
3. Excellent water-resistant and flexibility.
4. Super doughty wearable and higher intensity of stretch.



### Specification

Type [Note1]	Tube OD (mm)	Tube ID (mm)	Wall Thickness (mm)	Package Length(m)	Working Pressure at 23°C (MPa)	Burst pressure at 23°C	Bend radius (mm)	Weight per 100M(kg)	Temperature (°C)
UN54D□060040□□	6.0	4.0	1.00	100	1.0	4.0	12	1.93	-20~70
UN54D□080050□□	8.0	5.0	1.50	100	1.0	4.0	18	3.66	
UN54D□100065□□	10.0	6.5	1.75	100	1.0	4.0	20	5.44	
UN54D□120080□□	12.0	8.0	2.00	100	1.0	4.0	20	7.56	

[Note1] "□□" in the type column is for "color"

### Ordering code

UN54D 120 080 100M Y

① ② ③ ④ ⑤

① Model	② Tube OD	③ Tube ID	④ Material length	⑤ Standard color
UN54D: Flame resistant tube54D±3	060: Φ6.0mm 080: Φ8.0mm 100: Φ10.0mm 120: Φ12.0mm	040: Φ4.0mm 050: Φ5.0mm 065: Φ6.5mm 080: Φ8.0mm	100M: 100 m/coil	BU: Blue BK: Black GN: Green WH: White R: Red Y: Yellow

### Relationship of operation pressure and temperature

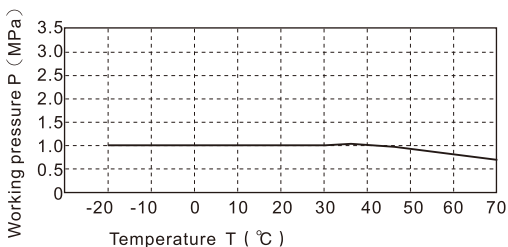

### Mini bend radius

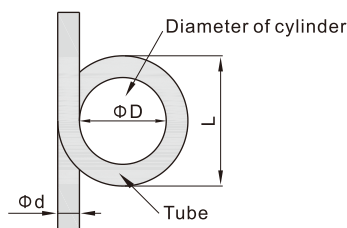

The least bend radius ( JIS method )

JIS method ( Base on JIS B8381 standard )

When the tube circle the cylinder tightly and the distortion rate is 25%, the cylinder radius is the least bend radius.

Testing condition: 20°C, 65%RH

$$N = \{1 - (L - D) / 2d\} \times 100$$

N=Distortion rate ( % ), less than 25% of standard value.

d=Tube diameter ( mm )

L=Measure value ( mm )

D=Diameter of cylinder ( mm )

## PC, POC series

### Ordering code

PC 6 01 □ □

① ② ③ ④ ⑤

① Model	② Port size	③ Thread connection		④ Standard color		⑤ Thread type
PC: Male connector 	4: $\Phi$ 4mm 6: $\Phi$ 6mm 8: $\Phi$ 8mm	Thread connection M5: M5X0.8	Adaptable port size $\Phi$ 4, $\Phi$ 6	Standard color Blank: Gray	Specification Release button: Gray	Blank: PT
POC: Male connector 	10: $\Phi$ 10mm 12: $\Phi$ 124mm	01: 1/8" 02: 1/4" 03: 3/8" 04: 1/2"	$\Phi$ 4, $\Phi$ 6 $\Phi$ 8, $\Phi$ 10 $\Phi$ 12	D: Black	Release button: Black	

### Specification

Operating pressure range	0~10kgf/cm <sup>2</sup> (0~1.0MPa)
Negative pressure	-750mmHg(10Torr)
Proof pressure	1.5MPa
Ambient and fluid temperature (°C)	-20~70
Applicable tubing	Soft nylon or polyurethane
Color	Gray/black

### Product feature

1. The compact appearance space saving.

2. The threaded portion is covered with sealant to prevent air leakage over the connection thread portion.

3. Gray and black are optional for the release button.

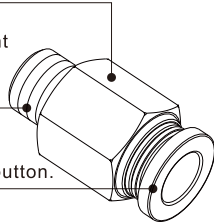

### Dimensions

#### PC Series

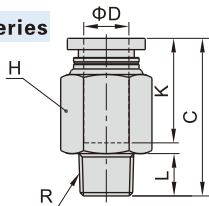

Model\Item	ΦD	R	L	C	K	H(Across flat)	Weight(g)	PCS/bag
PC401	4	PT1/8	7.5	19.5	14	10	7	10
PC402		PT1/4	10	19.5	14	14	13.5	10
PC601		PT1/8	7.5	22.0	18.5	12	7.5	10
PC602	6	PT1/4	10	24.5	18.5	14	15.5	10
PC603		PT3/8	11	22.5	18.5	17	24	10
PC604		PT1/2	14	26.0	18.5	21	46	10
PC801	8	PT1/8	7.5	28	18.5	14	13.5	10
PC802		PT1/4	10	27	18.5	14	13	10
PC803		PT3/8	11	23.5	18.5	17	21	10
PC804	PT1/2	14	27	18.5	21	43.5	10	
PC1001	10	PT1/8	7.5	30	21	17	20.5	10
PC1002		PT1/4	10	32.5	21	17	24	10
PC1003		PT3/8	11	28	21	17	20.5	10
PC1004	PT1/2	14	26.5	21	21	36	10	
PC1201	12	PT1/8	7.5	32.5	23	21	38.5	10
PC1202		PT1/4	10	35	23	21	40.5	10
PC1203		PT3/8	11	30.5	23	21	28.5	10
PC1204	PT1/2	14	32.5	23	21	41.5	10	

### Table for interface port and tube O.D.

Product series	Thread type	Port size				
		Φ4	Φ6	Φ8	Φ10	Φ12
PC	1/8"	●	●	●	●	●
	1/4"	●	●	●	●	●
	3/8"		●	●	●	●
	1/2"		●	●	●	●
POC	M5	●	●			
	1/8"	●	●	●	●	
	1/4"	●	●	●	●	●
	3/8"			●	●	●
	1/2"				●	●

### Inner structure

#### PC Series

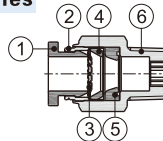

No.	Item	Material
1	Release button	POM
2	Guide	Aluminum alloy
3	Spring gasket	Stainless steel
4	Chuck	POM
5	O-ring	NBR
6	Body	Brass

#### POC Series

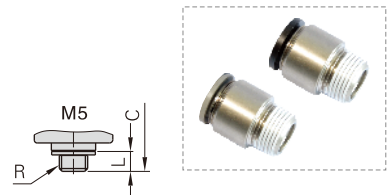
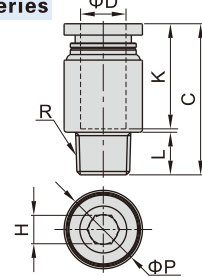



Model\Item	ΦD	R	ΦP	L	C	K	H(Across flat)	Weight(g)	PCS/bag
POC4M5		M5×0.8	9	3.5	18.5	14	2.5	3.6	10
POC401	4	PT1/8	10	7.5	18	14	3	5.5	10
POC402		PT1/4	14	10	19.5	14	3	12.6	10
POC6M5		M5×0.8	12	3.5	21.5	16.5	2	5.9	10
POC601	6	PT1/8	12	7.5	22.0	18.5	4	6.3	10
POC602		PT1/4	14	10	22.0	18.5	4	11.8	10
POC801	8	PT1/8	14	7.5	26.5	18	5	9.9	10
POC802		PT1/4	14	10	25	18	6	10.1	10
POC803	PT3/8	17	11	23.5	18	6	19.3	10	
POC1001	10	PT1/8	17	7.5	30	21	5	16.5	10
POC1002		PT1/4	17	10	29	21	6	15.4	10
POC1003	PT3/8	17	11	28	21	8	18.7	10	
POC1004	PT1/2	21	14	26.5	21	8	35.3	10	
POC1202	12	PT1/4	21	10	34.5	23	6	32.3	10
POC1203		PT3/8	21	11	30	23	8	25.1	10
POC1204		PT1/2	21	14	32	23	8	37.5	10

### Ordering code

PC 6 01 □ □ - M

① ② ③ ④ ⑤ ⑥

① Model	② Port size	③ Thread connection	④ Standard color	⑤ Thread type	⑥ Style type
PC: Male connector 	4: $\Phi$ 4mm 6: $\Phi$ 6mm	Thread connection: Adaptable port size	Standard color: Specification	Blank: PT	M: Mini type
PL: Male elbow 	01: 1/8"	$\Phi$ 4, $\Phi$ 6	Blank: Gray Release button: Gray D: Black Release button: Black		

### Specification

Operating pressure range	0~10kgf/cm <sup>2</sup> (0~1.0MPa)
Negative pressure	-750mmHg(10Torr)
Proof pressure	1.5MPa
Ambient and fluid temperature (°C)	-20~70
Applicable tubing	Soft nylon or polyurethane
Color	Gray/black

### Table for interface port and tube O.D.

Product series	Thread type	Port size	
		$\Phi$ 4	$\Phi$ 6
PC/PL	1/8"	●	●

### Product feature

1. The compact appearance space saving.
2. The threaded portion is covered with sealant to prevent air leakage over the connection thread portion.
3. Gray and black are optional for the release button.

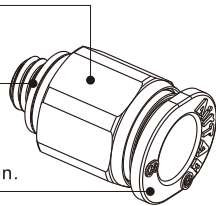

### Dimensions

#### PC Series

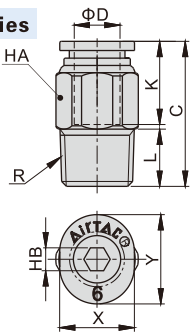

#### PL Series

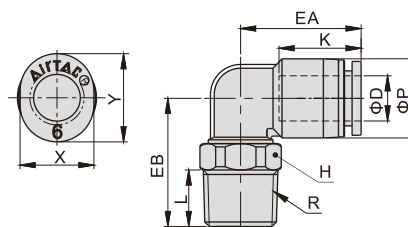

Model\Item	$\Phi$ D	R	L	C	K	X	Y	HA	HB	Weight(g)	PCS/bag
PC401-M	4	PT1/8	7.5	17.5	13.5	7.8	9.5	10	3	5.5	10
PC601-M	6	PT1/8	7.5	19.0	15.5	9.8	11.7	10	4	6.0	10

Model\Item	$\Phi$ D	R	$\Phi$ P	L	K	EA	EB	H	X	Y	Weight(g)	PCS/bag
PL401-M	4	PT1/8	8.5	7.5	12.5	15	16	10	7.8	9.5	6.2	10
PL601-M	6	PT1/8	10.5	7.5	13.5	16.0	16.5	10	9.8	11.7	6.8	10

## One-touch fittings—threaded type

### Ordering code

Same diameter type fittings

PL 6 01 □ □  
 ① ② ③ ④ ⑤

① Model	② Port size	③ Thread connection	④ Standard color	⑤ Thread type		
PHW: Double universal male elbow 	PL: Male elbow 	Thread connection	Standard color	Blank: PT		
PHF: Universal female elbow 	PLL: Extended male elbow 	Adaptable port size	Specification			
PEB: Male branch tee 	PLF: Female elbow 	01: 1/8" 02: 1/4" 03: 3/8" 04: 1/2"	Release button: Gray		Adaptable model	
PED: Male run tee 	PCF: Female connector 		Blank: Gray		Release button: Gray	Others
PYB: Branch "Y" 	PMF: Bulkhead connector 				D: Black	Body: Gray
PZB: Threaded cross 	PH: Universal male elbow 		Φ4, Φ6 Φ8, Φ10 Φ12			Release button: Black
					Release button: Black	Others
				Body: Black		

Different diameter type fittings

PKD 6 - 4 01 □ □  
 ① ② ③ ④ ⑤ ⑥

① Model	② Port size	③ Port size	④ Thread connection	⑤ Standard color	⑥ Thread type
PKD: Male reducer triple branch 	6: Φ6mm 8: Φ8mm 10: Φ10mm	4: Φ4mm 6: Φ6mm 8: Φ8mm	01: 1/8" 02: 1/4" 03: 3/8"	Standard color: Blank: Gray D: Black	Specification: Release button: Gray/Body: Gray Release button: Black/Body: Black

### Specification

<b>Operating pressure range</b>	0~10kgf/cm <sup>2</sup> (0~1.0MPa)
Negative pressure	-750mmHg(10Torr)
Proof pressure	1.5MPa
Ambient and fluid temperature (°C)	-20~70
Applicable tubing	Soft nylon or polyurethane
Color	Gray/black

### Product feature

- Variable models can be widely used in every kind of pneumatic systems.
- High circulation performance: bear the same flow with the volume of the tubing inside diameter.
- Connect tubing easily and conveniently. The tubing connection portion is safe and durable.
- The threaded portion is covered with sealant and the M5 thread is attached with a sealing gasket to prevent air leakage over the connection thread portion.
- The nickel plated body is anti-corrosion and anti-pollution, which allows a broader application.

### Inner structure

No.	Item	Material
1	Release button	POM
2	Guide	Aluminum alloy
3	Spring gasket	Stainless steel
4	Chuck	POM
5	O-ring	NBR
6	Body	PBT
7	O-ring	NBR
8	Stud	Brass

### Table for interface port and tube O.D.

Product series	Thread type	Port size				
		Φ4	Φ6	Φ8	Φ10	Φ12
PL	1/8"	●	●	●	●	●
	1/4"	●	●	●	●	●
	3/8"		●	●	●	●
PLL	1/2"		●	●	●	●
	1/8"	●	●	●	●	
	1/4"	●	●	●	●	
PEB PED PYB	3/8"		●	●	●	●
	1/2"			●	●	●
	1/8"	●	●	●	●	
PH PHF	1/4"		●	●	●	
	3/8"		●	●	●	●
	1/2"			●	●	●
PHW	1/8"	●	●	●		
	1/4"		●	●	●	
	3/8"		●	●	●	●
PZB	1/2"			●	●	●
	1/8"	●	●	●		
	1/4"		●	●	●	

Product series	Thread type	Port size		
		Φ6-Φ4	Φ8-Φ6	Φ10-Φ8
PKD	1/8"	●		
	1/4"		●	
	3/8"			●



## One-touch fittings—threaded type

### Dimensions

#### PL Series

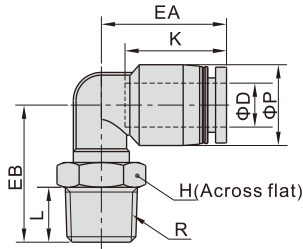

#### PCF Series

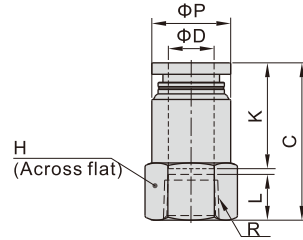

Model\Item	ΦD	R	ΦP	L	K	EA	EB	H	Weight(g)	PCS/bag
PL401	4	PT1/8	9	7.5	14	17	18.5	10	4.5	10
PL402		PT1/4	9	10	14	17	22.0	14	12	10
PL601	6	PT1/8	12.5	7.5	17	20	20.5	10	6	10
PL602		PT1/4	12.5	10	17	20	24.0	14	13.5	10
PL603		PT3/8	12.5	11	17	20	25.5	17	20.5	10
PL604	8	PT1/2	12.5	14	17	20	30.0	21	36	10
PL801		PT1/8	15	7.5	18.5	23	20.5	10	7.5	10
PL802		PT1/4	15	10	18.5	23	25.0	14	13	10
PL803		PT3/8	15	11	18.5	23	26.5	17	21	10
PL804	10	PT1/2	15	14	18.5	23	31.0	21	36	10
PL1001		PT1/8	18	7.5	21	25.5	25.0	17	16.5	10
PL1002		PT1/4	18	10	21	25.5	27.0	17	19	10
PL1003		PT3/8	18	11	21	25.5	28.0	17	21	10
PL1004		PT1/2	18	14	21	25.5	32.5	21	37	10
PL1201	12	PT1/8	21	7.5	23	28.5	26.5	17	19	10
PL1202		PT1/4	21	10	23	28.5	28.5	17	21.5	10
PL1203		PT3/8	21	11	23	29.5	33	17	25.5	10
PL1204		PT1/2	21	14	23	29.5	34	21	37	10

Model\Item	ΦD	R	ΦP	L	C	K	H	Weight(g)	PCS/bag
PCF401	4	PT1/8	9.5	8	23	14	14	4.5	10
PCF402		PT1/4	9.5	11	26	14	17	6.5	10
PCF601	6	PT1/8	12.5	8	25.5	16.5	14	5.6	10
PCF602		PT1/4	12.5	11	28.5	16.5	17	7.5	10
PCF603		PT3/8	13	12	29.5	16.5	21	10.7	10
PCF604	8	PT1/2	13	13.5	31.0	16.5	25	13.8	10
PCF801		PT1/8	14	8	27.5	18.5	14	5.8	10
PCF802		PT1/4	14.5	11	30.5	18.5	17	8.4	10
PCF803		PT3/8	14.5	12	31.5	18.5	21	11.2	10
PCF804	10	PT1/2	14.5	13.5	33	18.5	25	14.4	10
PCF1001		PT1/8	17	8	29	21	17	9.5	10
PCF1002		PT1/4	17	11	33	21	17	9.9	10
PCF1003		PT3/8	18	12	34	21	21	14	10
PCF1004		PT1/2	18	13.5	35.5	21	25	17.1	10
PCF1202	12	PT1/4	21	11	33.5	23	21	17.5	10
PCF1203		PT3/8	21	12	35.5	23	21	16.6	10
PCF1204		PT1/2	21	13.5	37	23	25	19.7	10

#### PMF Series

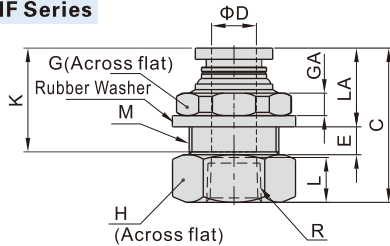

#### PLF Series

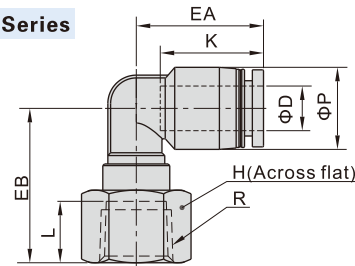

Model\Item	ΦD	R	M	L	C	K	LA	E	GA	G	H	Weight(g)	PCS/bag
PMF401	4	PT1/8	M12X1	8	25	14	12	4	4	14	14	6.4	10
PMF402		PT1/4	M12X1	11	29	14	12	4	4	14	17	9	10
PMF601	6	PT1/8	M14X1	8	25.5	16.5	12.5	5	4	17	17	9.1	10
PMF602		PT1/4	M14X1	11	30.5	16.5	12.5	5	4	17	17	10.9	10
PMF603		PT3/8	M14X1	12	31.5	16.5	12.5	5	4	17	21	13.2	10
PMF801	8	PT1/8	M16X1	8	27.5	18.5	13.5	5.5	4	19	19	12.8	10
PMF802		PT1/4	M16X1	11	32	18.5	13.5	5.5	4	19	19	15.7	10
PMF803		PT3/8	M16X1	12	33	18.5	13.5	5.5	4	19	21	15	10
PMF804		PT1/2	M16X1	13.5	34.5	18.5	13.5	5.5	4	19	25	18.1	10
PMF1001	10	PT1/8	M20X1	8	30	21	14.5	7.5	5	24	22	19.6	10
PMF1002		PT1/4	M20X1	11	35	21	14.5	7.5	5	24	22	22.8	10
PMF1003		PT3/8	M20X1	12	36	21	14.5	7.5	5	24	22	21.1	10
PMF1004		PT1/2	M20X1	13.5	37.5	21	14.5	7.5	5	24	25	23.2	10
PMF1202		12	PT1/4	M22X1	11	34.5	23	15.5	8	6	27	24	26.2
PMF1203	PT3/8		M22X1	12	37.5	23	15.5	8	6	27	24	27	10
PMF1204	PT1/2		M22X1	13.5	39	23	15.5	8	6	27	25	26.2	10

Model\Item	ΦD	R	ΦP	L	K	EA	EB	H	Weight(g)	PCS/bag
PLF401	4	PT1/8	9	8	14	17	21	14	4.6	10
PLF402		PT1/4	9	11	14	17	24	17	6.8	10
PLF601	6	PT1/8	12.5	8	17	20	23	14	5.8	10
PLF602		PT1/4	12.5	11	17	20	26	17	8	10
PLF603		PT3/8	12.5	12	17	20	27	21	10.7	10
PLF801	8	PT1/8	15	8	18.5	23	20	14	6.6	10
PLF802		PT1/4	15	11	18.5	23	27.5	17	9.2	10
PLF803		PT3/8	15	12	18.5	23	28.5	21	11.9	10
PLF804		PT1/2	15	13.5	18.5	23	30	25	15.2	10
PLF1001	10	PT1/8	18	8	21	25.5	24	17	11.3	10
PLF1002		PT1/4	18	11	21	25.5	26.5	17	11.2	10
PLF1003		PT3/8	18	12	21	25.5	30	21	14.5	10
PLF1004		PT1/2	18	13.5	21	25.5	31.5	25	17.4	10
PLF1202		12	PT1/4	21	11	23	28.5	28.5	17	13.7
PLF1203	PT3/8		21	12	23	29.5	32	21	17.4	10
PLF1204	PT1/2		21	13.5	23	29.5	33	25	20.4	10

# Accessories—One-Touch Fittings

## One-touch fittings—threaded type

### PLL Series

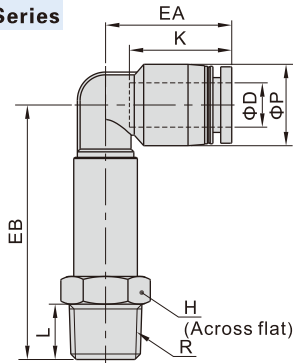

### PHW Series

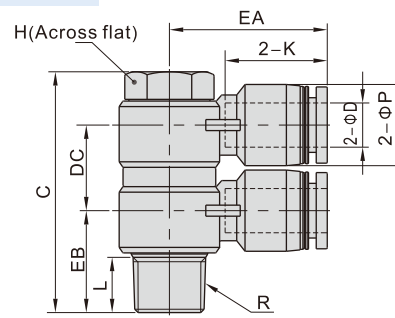

Model/Item	ΦD	R	ΦP	L	K	EA	EB	H	Weight(g)	PCS/bag
PLL401	4	PT1/8	9	7.5	14	17	35.5	10	12.3	10
PLL402		PT1/4	9	10	14	17	38.5	14	16.9	10
PLL601	6	PT1/8	12.5	7.5	17	20	37.5	10	13	10
PLL602		PT1/4	12.5	10	17	20	40.5	14	18	10
PLL603	6	PT3/8	12.5	11	17	20	43	17	23.4	10
PLL801		PT1/8	15	7.5	18.5	23	43.5	12	16.6	10
PLL802	8	PT1/4	15	10	18.5	23	45.5	14	22.7	10
PLL803		PT3/8	15	11	18.5	23	48	17	27.7	10
PLL1001	10	PT1/8	18	7.5	21	25.5	50.5	15	37.5	10
PLL1002		PT1/4	18	10	21	25.5	53.5	15	40.6	10
PLL1003	10	PT3/8	18	11	21	25.5	54.5	17	40.7	10
PLL1004		PT1/2	18	14	21	25.5	59	21	47.4	10
PLL1202	12	PT1/4	21	10	23	28.5	55.5	15	43	10
PLL1203		PT3/8	21	11	23	29.5	60	17	55.4	10
PLL1204	12	PT1/2	21	14	23	29.5	63	21	56.7	10

Model/Item	ΦD	R	ΦP	L	C	K	EA	EB	DC	H	Weight(g)	PCS/bag
PHW401	4	PT1/8	9	7.5	38	14	20.5	14.5	13	11	19	10
PHW601		PT1/8	12.5	7.5	38	16.5	23.0	15	13	11	21	10
PHW602	6	PT1/4	12.5	10	43.5	16.5	25.0	17.5	15.5	14	40.2	10
PHW603		PT3/8	12.5	11	50	16.5	27.0	20	16.5	19	69.2	5
PHW801	8	PT1/8	15	7.5	40.5	18.5	26.5	16.5	15.5	11	23.6	10
PHW802		PT1/4	15	10	43.5	18.5	28.5	18.5	15.5	14	40.8	10
PHW803	8	PT3/8	15	11	50	18.5	29.5	20	16.5	19	70.4	5
PHW804		PT1/2	15	14	61	18.5	32	24.5	22	24	134.8	5
PHW1002	10	PT1/4	18	10	46.5	21	31	20	18.5	14	47	10
PHW1003		PT3/8	18	11	55	21	33	21	22	19	87.5	5
PHW1004	12	PT1/2	18	14	61	21	35.5	25	22	24	137.7	5
PHW1203		PT3/8	21	11	55	23	36	23	22	19	86.4	5
PHW1204	12	PT1/2	21	14	61	23	38	26.5	22	24	147.5	5

### PH Series

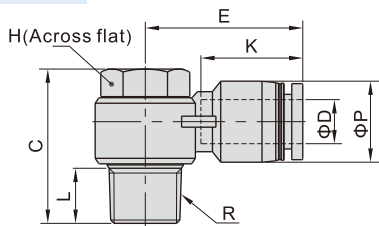

### PHF Series

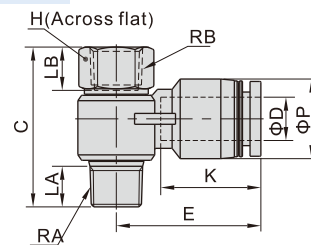

Model/Item	ΦD	R	ΦP	L	C	K	E	H	Weight(g)	PCS/bag
PH401	4	PT1/8	9	7.5	25	14	20.5	11	12.8	10
PH601		PT1/8	12.5	7.5	25	16.5	23	11	14	10
PH602	6	PT1/4	12.5	10	28	16.5	25	14	25.4	10
PH603		PT3/8	12.5	11	33	16.5	27	19	50.2	5
PH801	8	PT1/8	15	7.5	25	18.5	26.5	11	14.7	10
PH802		PT1/4	15	10	28	18.5	28.5	14	26.4	10
PH803	8	PT3/8	15	11	33	18.5	29.5	19	49.4	5
PH804		PT1/2	15	14	39	18.5	32	24	89	5
PH1002	10	PT1/4	18	10	28	21	31	14	27.7	10
PH1003		PT3/8	18	11	33	21	33	19	51.1	5
PH1004	12	PT1/2	18	14	39	21	35.5	24	88.5	5
PH1203		PT3/8	21	11	33	23	36	19	53	5
PH1204	12	PT1/2	21	14	39	23	38	24	92.8	5

Model/Item	ΦD	RA	RB	ΦP	LA	LB	C	K	E	H	Weight(g)	PCS/bag
PHF401	4	PT1/8	PT1/8	9	7.5	8	29.5	14	20.5	12	12.9	10
PHF601		PT1/8	PT1/8	12.5	7.5	8	29.5	16.5	23	12	13.9	10
PHF602	6	PT1/4	PT1/4	12.5	10	11	35	16.5	25	17	30.3	10
PHF603		PT3/8	PT3/8	12.5	11	12	40	16.5	27	19	44.2	5
PHF801	8	PT1/8	PT1/8	15	7.5	8	29.5	18.5	26.5	12	15	10
PHF802		PT1/4	PT1/4	15	10	11	35	18.5	28.5	17	30.7	10
PHF803	8	PT3/8	PT3/8	15	11	12	40	18.5	29.5	19	44.8	5
PHF804		PT1/2	PT1/2	15	14	13.5	47.5	18.5	32	24	84.7	5
PHF1002	10	PT1/4	PT1/4	18	10	11	35	21	31	17	32	10
PHF1003		PT3/8	PT3/8	18	11	12	40	21	33	19	46.2	5
PHF1004	12	PT1/2	PT1/2	18	14	13.5	47.5	21	35.5	24	86.1	5
PHF1203		PT3/8	PT3/8	21	11	12	40	23	36	19	48.4	5
PHF1204	12	PT1/2	PT1/2	21	14	13.5	47.5	23	38	24	89.7	5

### PKD Series

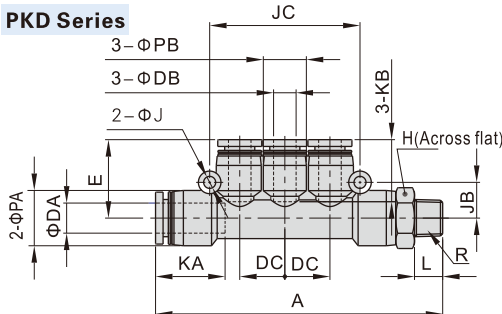

Model/Item	ΦDA	ΦDB	R	L	A	ΦPA	ΦPB	KA	KB
PKD6-401	6	4	PT1/8	7.5	66.5	12.5	9	16.5	14
PKD8-602	8	6	PT1/4	10	79	15	12.5	18.5	16.5
PKD10-803	10	8	PT3/8	11	91.5	18	15	21	18.5

  

Model/Item	ΦJ	JB	JC	DC	E	H	Weight(g)	PCS/bag
PKD6-401	3.2	8	34	10	17.5	12	15.8	2
PKD8-602	3.2	9.5	40	12	21	14	26.5	2
PKD10-803	4.3	11	48	14.5	24	17	38.2	2

# Accessories—One-Touch Fittings

## One-touch fittings—threaded type

### PEB Series

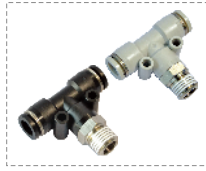
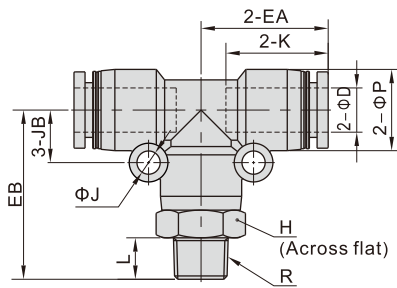

Model/Item	ΦD	R	ΦP	L	K	EA	EB	ΦJ	JB	H	Weight(g)	PCS/bag
PEB401	4	PT1/8	9	7.5	14	17	25	3.2	6.5	10	8.8	10
PEB402	4	PT1/4	9	10	14	17	28	3.2	6.5	14	15.5	10
PEB601	6	PT1/8	12.5	7.5	16.5	20	27.5	3.2	8	12	13.5	10
PEB602	6	PT1/4	12.5	10	16.5	20	30.5	3.2	8	14	18.6	10
PEB603	6	PT3/8	12.5	11	16.5	20	32	3.2	8	17	25.3	10
PEB801	8	PT1/8	15	7.5	18.5	23	30.5	4.3	9.5	14	18.4	10
PEB802	8	PT1/4	15	10	18.5	23	33	4.3	9.5	14	21.3	10
PEB803	8	PT3/8	15	11	18.5	23	34.5	4.3	9.5	17	28.2	10
PEB804	8	PT1/2	15	14	18.5	23	38.5	4.3	9.5	21	41	10
PEB1001	10	PT1/8	18	7.5	21	26.5	34	4.3	11	17	26.7	10
PEB1002	10	PT1/4	18	10	21	26.5	36.5	4.3	11	17	29.2	10
PEB1003	10	PT3/8	18	11	21	26.5	37.5	4.3	11	17	31.9	10
PEB1004	10	PT1/2	18	14	21	26.5	41.5	4.3	11	21	45.4	10
PEB1202	12	PT1/4	21	10	23	30	41	4.3	13	21	49.6	10
PEB1203	12	PT3/8	21	11	23	30	42	4.3	13	21	51.2	10
PEB1204	12	PT1/2	21	14	23	30	45	4.3	13	21	57.3	10

### PYB Series

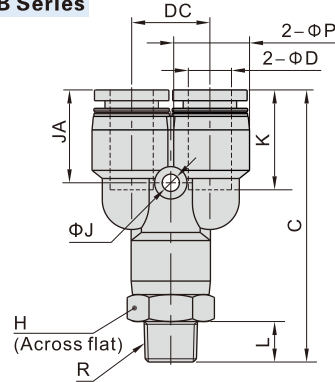

Model/Item	ΦD	R	ΦP	L	C	K	ΦJ	JA	DC	H	Weight(g)	PCS/bag
PYB401	4	PT1/8	9	7.5	39.5	14	3.2	13	10	10	9	10
PYB402	4	PT1/4	9	10	42.5	14	3.2	13	10	14	10.8	10
PYB601	6	PT1/8	12.5	7.5	44.5	16.5	3.2	15.5	12	12	13.7	10
PYB602	6	PT1/4	12.5	10	47.5	16.5	3.2	15.5	12	14	18.2	10
PYB603	6	PT3/8	12.5	11	49.0	16.5	3.2	15.5	12	17	25	10
PYB801	8	PT1/8	15	7.5	50	18.5	3.2	17	14.5	14	19.8	10
PYB802	8	PT1/4	15	10	52.5	18.5	3.2	17	14.5	14	22	10
PYB803	8	PT3/8	15	11	54	18.5	3.2	17	14.5	17	27.7	10
PYB804	8	PT1/2	15	14	58	18.5	3.2	17	14.5	21	40.8	10
PYB1001	10	PT1/8	18	7.5	56.5	21	4.3	19.5	18	17	27.4	10
PYB1002	10	PT1/4	18	10	59	21	4.3	19.5	18	17	29.5	10
PYB1003	10	PT3/8	18	11	60	21	4.3	19.5	18	17	32.5	10
PYB1004	10	PT1/2	18	14	64	21	4.3	19.5	18	21	45.4	10
PYB1202	12	PT1/4	21	10	66	23	4.3	21	20.5	21	27.3	10
PYB1203	12	PT3/8	21	11	67	23	4.3	21	20.5	21	51.8	10
PYB1204	12	PT1/2	21	14	70	23	4.3	21	20.5	21	56.8	10

### PED Series

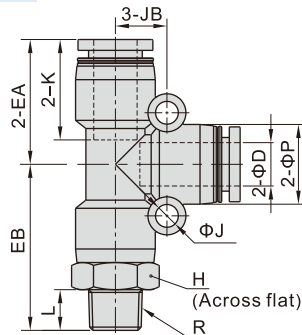

Model/Item	ΦD	R	ΦP	L	K	EA	EB	ΦJ	JB	H	Weight(g)	PCS/bag
PED401	4	PT1/8	9	7.5	14	17	25	3.2	6.5	10	8.8	10
PED402	4	PT1/4	9	10	14	17	28	3.2	6.5	14	15.5	10
PED601	6	PT1/8	12.5	7.5	16.5	20	27.5	3.2	8	12	13.5	10
PED602	6	PT1/4	12.5	10	16.5	20	30.5	3.2	8	14	18.6	10
PED603	6	PT3/8	12.5	11	16.5	20	32	3.2	8	17	25.3	10
PED801	8	PT1/8	15	7.5	18.5	23	30.5	4.3	9.5	14	18.4	10
PED802	8	PT1/4	15	10	18.5	23	33	4.3	9.5	14	21.3	10
PED803	8	PT3/8	15	11	18.5	23	34.5	4.3	9.5	17	28.2	10
PED804	8	PT1/2	15	14	18.5	23	38.5	4.3	9.5	21	41	10
PED1001	10	PT1/8	18	7.5	21	26.5	34	4.3	11	17	26.7	10
PED1002	10	PT1/4	18	10	21	26.5	36.5	4.3	11	17	29.2	10
PED1003	10	PT3/8	18	11	21	26.5	37.5	4.3	11	17	31.9	10
PED1004	10	PT1/2	18	14	21	26.5	41.5	4.3	11	21	45.4	10
PED1202	12	PT1/4	21	10	23	30	41	4.3	13	21	49.6	10
PED1203	12	PT3/8	21	11	23	30	42	4.3	13	21	51.2	10
PED1204	12	PT1/2	21	14	23	30	45	4.3	13	21	57.3	10

### PZB Series

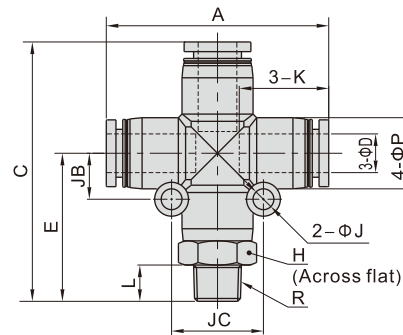

Model/Item	ΦD	R	L	A	E	C	ΦP	K	ΦJ	JB	JC	H	Weight(g)	PCS/bag
PZB601	6	PT1/8	7.5	27.5	47.5	12.5	16.5	3.2	8	16	12	15.2	10	
PZB602	6	PT1/4	10	39.5	30.5	50.5	12.5	16.5	3.2	8	16	14	20.4	10
PZB603	6	PT3/8	11	32	52	15	18.5	4.3	9.5	19	17	27	10	
PZB801	8	PT1/8	7.5	30.5	53.5	15	18.5	4.3	9.5	19	14	20.9	10	
PZB802	8	PT1/4	10	33	56	15	18.5	4.3	9.5	19	14	23.8	10	
PZB803	8	PT3/8	11	46	34.5	57.5	15	18.5	4.3	9.5	17	29.9	10	
PZB804	8	PT1/2	14	38.5	61.5	15	18.5	4.3	9.5	19	21	43.5	10	
PZB1002	10	PT1/4	10	36.5	63	18	21	4.3	11	22	17	33.5	10	
PZB1003	10	PT3/8	11	52.5	37.5	64	18	21	4.3	11	22	17	36.5	10
PZB1004	10	PT1/2	14	41.5	68	18	21	4.3	11	22	21	49.2	10	
PZB1203	12	PT3/8	11	59.5	42	72	21	23	4.3	13	26	21	56.5	10
PZB1204	12	PT1/2	14	45	75	21	23	4.3	13	26	21	65.4	10	





## Metal one-touch fittings

### Ordering code

BPC 6 01 □

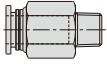
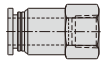
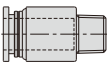
① ② ③ ④

① Model	② Port size	③ Thread connection	④ Thread type
BPC: Metal male connector 	4: Φ 4mm 6: Φ 6mm 8: Φ 8mm 10: Φ 10mm 12: Φ 12mm	M5: M5X0.8 01: 1/8" 02: 1/4" 03: 3/8" 04: 1/2"	Blank: PT
BPCF: Metal female connector 			
BPOC: Hexagon socket head metal male connector 	BPMF: Metal bulkhead female connector 		

### Specification

<b>Operating pressure range</b>	<b>0~9kgf/cm<sup>2</sup>(0~0.9MPa)</b>
Negative pressure	-750mmHg(10Torr)
Proof pressure	1.5MPa
Ambient and fluid temperature (°C)	0~150
Applicable tubing	Soft nylon or polyurethane
Color	Gray/black

Note: The temperature resistance level of the tubing should be confirmed first when used in high temperature environments.

### Product feature

1. High flow capacity; The flow rate of these fittings is equivalent to that of the adaptable tubings.
2. Inserting or removal tubing is simple and convenient, and the connecting portion is reliable and durable.
3. Sealant is coated on threaded portion.
4. The fitting metal body adopts a special nickel-plating process, which has good corrosion resistance.
5. Metal fittings can be used in high temperature environment.

### Table for interface port and tube O.D.

Product series	Thread type	Port size				
		Φ4	Φ6	Φ8	Φ10	Φ12
BPC	1/8"	●	●	●	●	
	1/4"	●	●	●	●	●
	3/8"		●	●	●	●
	1/2"				●	●
BPOC	M5	●	●			
	1/8"	●	●	●		
	1/4"		●	●	●	
	3/8"				●	●
BPCF	1/8"	●	●	●		
	1/4"		●	●	●	
	3/8"				●	●
	1/2"					●
BPMF	1/8"	●	●	●		
	1/4"		●	●	●	
	3/8"				●	●
	1/2"					●

### Inner structure

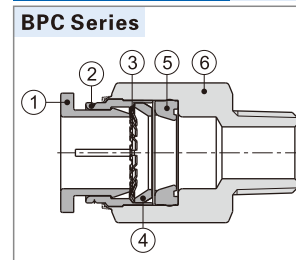

NO.	Name	Material
1	Metal connector	Brass
2	Locating ring	Aluminum alloy
3	Spring gasket	Stainless steel
4	Locating seat	Aluminum alloy
5	Special shape O-ring	Viton
6	Straight connector body	Brass

## Metal one-touch fittings

### Dimensions

#### BPC Series

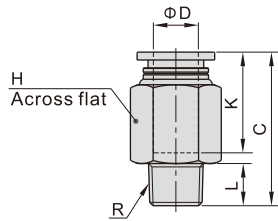

Model\Item	ΦD	R	L	C	K	H	Weight(g)	PCS/bag
BPC401	4	PT1/8	7.5	19.5	14	10	7.9	10
BPC402		PT1/4	10	19	14	14	8.7	10
BPC601	6	PT1/8	7.5	21.5	18	12	14.2	10
BPC602		PT1/4	10	24	18	14	19.1	10
BPC603	8	PT3/8	11	22.5	18	17	26.8	10
BPC801		PT1/8	7.5	27.5	18	14	16.1	10
BPC802	10	PT1/4	10	26.5	18	14	16	10
BPC803		PT3/8	11	23	18	17	25.4	10
BPC1001	12	PT1/8	7.5	29.5	20.5	17	24.5	10
BPC1002		PT1/4	10	32	20.5	17	28	10
BPC1003	10	PT3/8	11	27.5	20.5	17	34.6	10
BPC1004		PT1/2	14	25.5	20.5	21	39.3	10
BPC1202	12	PT1/4	10	34.5	22	21	44.5	10
BPC1203		PT3/8	11	30	22	21	34.2	10
BPC1204	PT1/2	14	32	22	21	47	10	

#### BPOC Series

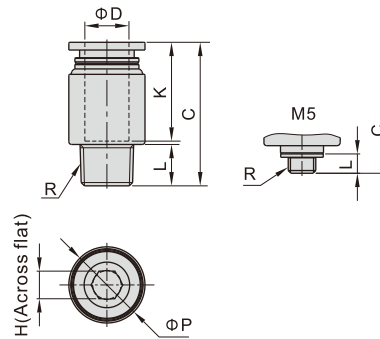

Model\Item	ΦD	R	ΦP	L	C	K	H	Weight(g)	PCS/bag
BPOC4M5	4	M5X0.8	9	3.5	18.5	14	2	4.4	10
BPOC401		PT1/8	10	7.5	17.5	14	2.5	6.6	10
BPOC6M5	6	M5X0.8	12	3.5	21	16	2	7.1	10
BPOC601		PT1/8	12	7.5	21.5	18	4	8.4	10
BPOC602	8	PT1/4	14	10	21.5	18	4	13.6	10
BPOC801		PT1/8	14	7.5	26	17.5	5	12.3	10
BPOC802	10	PT1/4	14	10	24.5	17.5	6	12.7	10
BPOC1002		PT1/4	17	10	28.5	20.5	6	18.5	10
BPOC1003	12	PT3/8	17	11	27.5	20.5	8	24.9	10
BPOC1203		PT3/8	21	11	29.5	22	8	30.4	10
BPOC1204	PT1/2	21	14	31.5	22	8	42.4	10	

#### BPCF Series

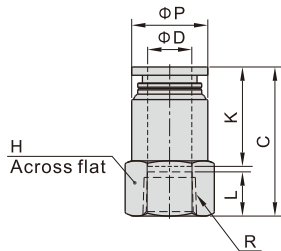

Model\Item	ΦD	R	ΦP	L	C	K	H	Weight(g)	PCS/bag
BPCF401	4	PT1/8	9.5	8	23	14	14	5.3	10
BPCF601		PT1/8	12.5	8	25	16	14	7.2	10
BPCF602	6	PT1/4	12.5	11	28	16	17	9.2	10
BPCF801		PT1/8	14	8	27	18	14	7.1	10
BPCF802	8	PT1/4	14.5	11	30	18	17	10.6	10
BPCF1002		PT1/4	17	11	32.5	20.5	17	13.5	10
BPCF1003	10	PT3/8	18	12	33.5	20.5	21	17.5	10
BPCF1203		PT3/8	21	12	35	22	21	22	10
BPCF1204	PT1/2	21	13.5	36.5	22	25	24.9	10	

#### BPMF Series

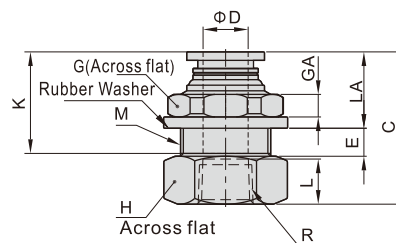

Model\Item	ΦD	R	M	L	C	K	LA	E	GA	G	H	Weight(g)	PCS/bag
BPMF401	4	PT1/8	M12X1	8	25	14	12	4	4	14	14	7.6	10
BPMF601		PT1/8	M14X1	8	25	16	12	5	4	17	17	10.4	10
BPMF602	6	PT1/4	M14X1	11	30	16	12	5	4	17	17	12.2	10
BPMF801		PT1/8	M16X1	8	27	18	13	5.5	4	19	19	13.9	10
BPMF802	8	PT1/4	M16X1	11	31.5	18	13	5.5	4	19	19	15.3	10
BPMF1002		PT1/4	M20X1	11	34.5	20.5	14	7.5	5	24	22	26.2	10
BPMF1003	10	PT3/8	M20X1	12	35.5	20.5	14	7.5	5	24	22	24.4	10
BPMF1203		PT3/8	M22X1	12	37	22	15	8	6	27	24	32.6	10
BPMF1204	PT1/2	M22X1	13.5	38.5	22	15	8	6	27	25	31.8	10	

## One-touch fittings—threaded type

### Ordering code

BB 01 01 □



① Model				② Thread connection I	③ Thread connection II	④ Thread type
BB: Male connector 	BD: Male & female connector[Note1] 	BU: Double female connector 	BZ: Hexagon head cap plug[Note2] 	01: 1/8" 02: 1/4" 03: 3/8" 04: 1/2"	01: 1/8" 02: 1/4" 03: 3/8" 04: 1/2"	Blank: PT

[Note1] For BD series, Thread I is Female thread, Thread II is male thread; [Note2] For BZ series, no thread II and thread I is male thread.

### Specification

Operating pressure range	0~10kgf/cm <sup>2</sup> (0~1.0MPa)
Negative pressure	-750mmHg(10Torr)
Proof pressure	3.0MPa
Ambient and fluid temperature (°C)	0~150

### Configuration table of tubing thread

Product series	Thread connection I	Thread connection II			
		01	02	03	04
BB	01	●	●	●	●
	02		●	●	●
	03			●	●
	04				●
BD	01		●	●	●
	02			●	●
	03				●
	04				
BU	01	●			
	02		●		
	03			●	
	04				●
Product series	Thread connection				
	01	02	03	04	
BZ	●	●	●	●	

### Product feature

- Variable models can be widely used in every kind of pneumatic systems.
- High circulation performance bear the same flow with the volume of the tube innerdiameter.
- The nickel plated body is anti-corrosion and anti-pollution, which allows a broader application.
- Metal fittings can be used in high temperature environment.

### Dimensions

#### BB Series

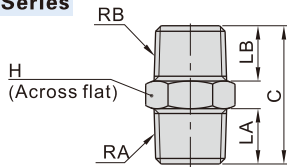

Model\Item	RA	RB	LA	LB	C	H	Weight(g)	PCS/bag
BB0101	PT1/8	PT1/8	7.5	7.5	19.5	10	6.6	10
BB0102	PT1/4	PT1/8	10	7.5	22.5	14	12.1	10
BB0103	PT3/8	PT1/8	11	7.5	24	17	18.3	10
BB0202	PT1/4	PT1/4	10	10	25	14	14.6	10
BB0203	PT3/8	PT1/4	11	10	26.5	17	20.3	10
BB0204	PT1/2	PT1/4	14	10	30	21	34.3	10
BB0303	PT3/8	PT3/8	11	11	27.5	17	23.2	10
BB0304	PT1/2	PT3/8	14	11	31	21	36.2	10
BB0404	PT1/2	PT1/2	14	14	34	21	42.8	10

#### BD Series

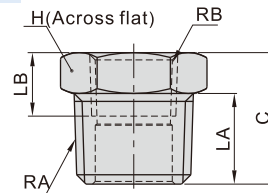

Model\Item	RA	RB	LA	LB	C	H	Weight(g)	PCS/bag
BD0102	PT1/4	PT1/8	10	8	14.5	14	8.8	10
BD0103	PT3/8	PT1/8	11	8	16	17	17.1	10
BD0104	PT1/2	PT1/8	14	8	19.5	21	33.1	10
BD0203	PT3/8	PT1/4	11	11	16	17	12.7	10
BD0204	PT1/2	PT1/4	14	11	19.5	21	29.9	10
BD0304	PT1/2	PT3/8	14	12	19.5	21	22.5	10

#### BU Series

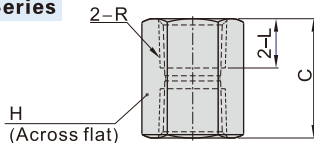

Model\Item	R	L	C	H	Weight(g)	PCS/bag
BU0101	PT1/8	8	17	12	8.4	10
BU0202	PT1/4	11	23	17	25.4	10
BU0303	PT3/8	12	25	21	40	10
BU0404	PT1/2	13.5	28	24	46.6	10

#### BZ Series

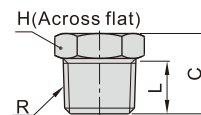

Model\Item	R	L	C	H	Weight(g)	PCS/bag
BZ01	PT1/8	7.5	11	10	4.6	10
BZ02	PT1/4	10	14.5	14	10.8	10
BZ03	PT3/8	11	16	17	17.4	10
BZ04	PT1/2	14	19.5	21	33	10

## One-touch fittings—threaded type

### Ordering code

BKC 06 04 - 01 □

① ② ③ ④ ⑤

① Model	② Tubing outer diameter	③ Tubing inner diameter	④ Thread connection	⑤ Thread type
BKC: Straight locknut connector 	04: Φ4mm 06: Φ6mm 08: Φ8mm 10: Φ10mm 12: Φ12mm	25: Φ2.5mm 04: Φ4mm 05: Φ5mm 06: Φ6mm 65: Φ6.5mm 75: Φ7.5mm 08: Φ8mm 09: Φ9mm	01: 1/8" 02: 1/4" 03: 3/8" 04: 1/2"	Blank: PT

Note: When using the tubing Φ8×Φ5.5, the straight lock nut connector of BKC0806can be used.

### Specification

Operating pressure range	0~10kgf/cm <sup>2</sup> (0~1.0MPa)
Negative pressure	-750mmHg(10Torr)
Proof pressure	3.0MPa
Ambient and fluid temperature (°C)	0~150

Note: The temperature resistance level of the tubing should be confirmed first when used in high temperature environments.

### Product feature

1. Variable models can be widely used in every kind of pneumatic systems.
2. High circulation performance bear the same flow with the volume of the tube innerdiamater.
3. The nickel plated body is anti-corrosion and anti-pollution, which allows a broader application.
4. Metal fittings can be used in high temperature environments.

### Dimensions

#### BKC Series

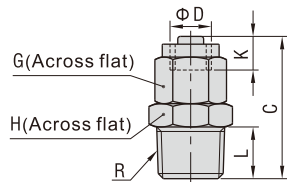

Model\Item	ΦD		R	L	C	K	G	H	Weight (g)	PCS/bag
	O.D	I.D								
BKC0425-01	4	2.5	PT1/8	7.5	20.5	5	8	10	7.1	10
BKC0604-01	6	4	PT1/8	7.5	22	5.5	10	10	9.9	10
BKC0604-02			PT1/4	10	25.5			14	15.8	10
BKC0604-03	6	4	PT3/8	11	27	5.5	10	17	22.5	10
BKC0805-01			PT1/8	7.5	24			12	12.8	10
BKC0805-02	8	5	PT1/4	10	27.5	6.5	12	14	17.2	10
BKC0805-03			PT3/8	11	29			17	23.7	10
BKC0806-01	8	5.5 or 6	PT1/8	7.5	24	6.5	12	12	13.1	10
BKC0806-02			PT1/4	10	27.5			14	17.2	10
BKC0806-03			PT3/8	11	29			17	23.6	10

### Configuration table of tubing and tubing thread

Product series	Tubing outer diameter	Tubing inner diameter	Thread connection			
			01	02	03	04
BKC	04	25	●			
	06	04	●	●	●	
	08	05	●	●	●	
		06	●	●	●	
	10	65		●	●	●
		75		●	●	●
	12	08		●	●	●
		09		●	●	●

### Installation and application

1. Method of inserting or removal a tubing
  - 1.1 Inserting a tubing  
Place the locking cap over the tubing, and insert the tubing into the body, then tighten the locking cap. (As figure 1)
  - 1.2 Removing a tubing  
Loosen the locking cap first, then remove the tubing. (As figure 2)
2. Method of tightening the connector thread  
Tighten the connector with a hex wrench, as shown right.

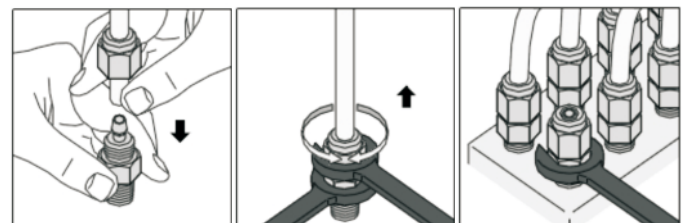

Figure 1

Figure 2

Figure 3

### Ordering code

BSL 01 □

① ② ③

① Silencer Type	② Thread connection	③ Standard color		
BSL: Universal silencer BSLM: Mini Silencer BESL: Throttling silencer PAL: Plastic silencer PALM: Mini plastic Silencer	01: 1/8" 02: 1/4" 03: 3/8" 04: 1/2"	Type	Color code	Color definition
		PAL、PALM	Blank: grey D: Black	Top cover: grey/Body: grey Top cover: black/Body: black
		Others	No such code	

### Product feature

#### BSL、BSLM、BESL Series:

1. This silencers have excellent noise silencing performance.
2. The installation of the silencer is simple and convenient, and the connecting portion is reliable and durable.
3. It is easy to adjust the exhaust flow of the throttling type silencer.

#### PAL Series、PALM Series:

1. The silencer body is made of plastic.
2. The mini type silencer has the characteristics of small volume and compact structure.

### Configuration table of tubing thread

Product series	Thread connection			
	01	02	03	04
BSL	●	●	●	●
BSLM	●	●	●	●
BESL	●	●	●	●
PAL	●	●	●	●
PALM	●	●	●	●

### Specification

Model	BSL01	BSL02	BSL03	BSL04		BSLM01	BSLM02	BSLM03	BSLM04	
Thread connection	1/8"	1/4"	3/8"	1/2"		1/8"	1/4"	3/8"	1/2"	
Silencing effect(dB)(0.5MPa)	20	20	20	12		20	20	20	20	
Model	BESL01	BESL02	BESL03	BESL04	PAL01	PAL02	PAL03	PAL04	PALM01	PALM02
Thread connection	1/8"	1/4"	3/8"	1/2"	1/8"	1/4"	3/8"	1/2"	1/8"	1/4"
Silencing effect(dB)(0.5MPa)	20	20	20	20	25	25	25	25	25	25
Operating pressure	0~10kgf/cm <sup>2</sup> (0~1.0MPa)									
Negative pressure	-750mmHg(10Torr)									
Proof pressure	1.5MPa									
Temperature range	-20~70℃									

### Inner structure

#### BSL Series

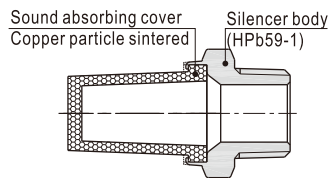

#### BESL Series

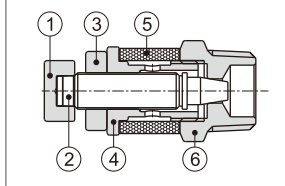

NO.	Name	Material
1	Adjusting cap	Aluminum alloy
2	Throttling column	Aluminum alloy
3	Locking cap	Aluminum alloy
4	Locking ring	Aluminum alloy
5	Silencer ring	Copper particle sintered
6	Silencer body	Brass

#### PAL Series

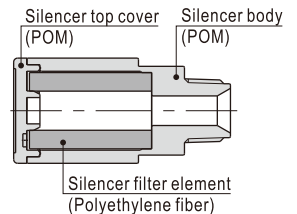

### Flowrate characteristic

#### BSL Series

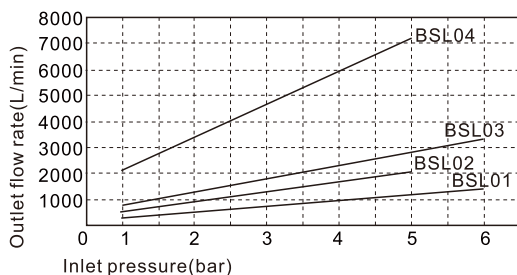

#### BSLM Series

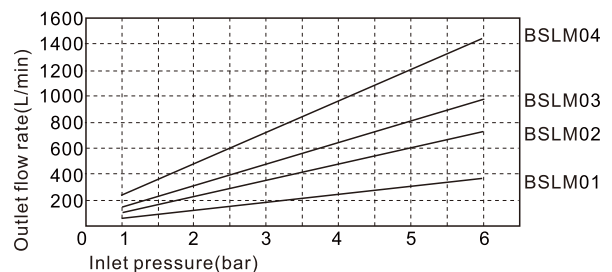

# Accessories—Silencers

BSL, BSLM, BESL, PAL, PALM series

## Flowrate characteristic

### PAL、PALM Series

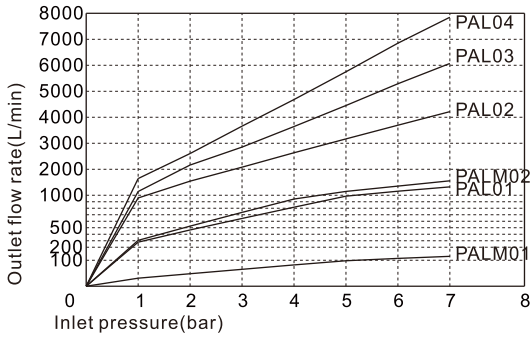

### BESL Series (Inlet pressure and outlet flow rate)

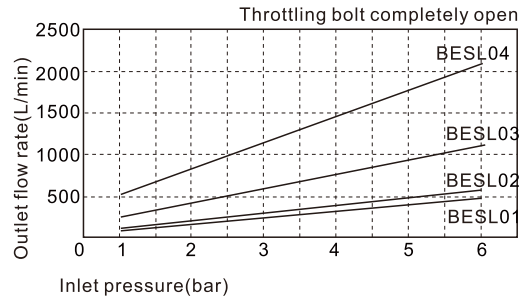

### BESL Series

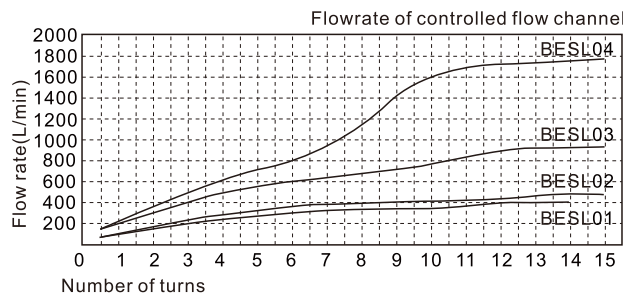

## Dimensions

### BSL Series

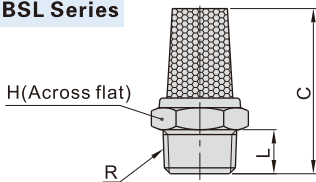

Model/Item	R	L	C	H	Weight(g)	PCS/bag
BSL01	PT1/8	6	24	12	6.7	10
BSL02	PT1/4	8	30	15	11.6	10
BSL03	PT3/8	9	38.5	19	22	10
BSL04	PT1/2	10.5	46	22	35	10

### BSLM Series

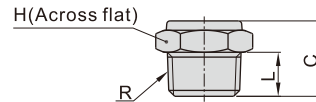

Model/Item	R	L	C	H	Weight(g)	PCS/bag
BSLM01	PT1/8	6	11	12	4.3	10
BSLM02	PT1/4	8	13.5	15	8.4	10
BSLM03	PT3/8	9	15.5	19	15.8	10
BSLM04	PT1/2	10.5	19	22	25.9	10

### BESL Series

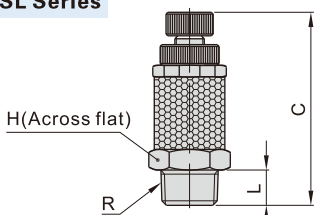

Model/Item	R	L	C		H	Weight(g)	PCS/bag
			max	min			
BESL01	PT1/8	6	40.5	33	12	10	10
BESL02	PT1/4	8	42.5	35	14	18.1	10
BESL03	PT3/8	9	49	41.5	17	31.1	10
BESL04	PT1/2	10.5	59.5	52	24	69.8	10

### PAL、PALM Series

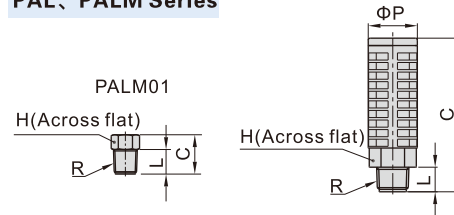

Model/Item	R	ΦP	L	C	H	Weight(g)	PCS/bag
PAL01	PT1/8	16	7	33	14	4.2	10
PALM01	PT1/8	/	10	16	10	0.9	10
PAL02	PT1/4	20	10	62.5	17	10.7	10
PALM02	PT1/4	16	10	36	14	5.1	10
PAL03	PT3/8	26	12	68	24	20	10
PAL04	PT1/2	28	12	73	24	23.1	10

### Ordering code

PSL 6 01 A □ □  
 ① ② ③ ④ ⑤ ⑥

① Model	② Port size	③ Thread connection		④ Control method	⑤ Standard color		⑥ Thread type
PSL: Speed controller 	4: Φ4mm 6: Φ6mm 8: Φ8mm 10: Φ10mm 12: Φ12mm	Thread	Adaptable port size	A: Meter-out  Handle marking "A" Controlled flow Free flow	Standard color	Specification	Blank: PT
PSS: Universal speed controller 		M5: M5X0.8 01: 1/8" 02: 1/4" 03: 3/8" 04: 1/2"	Φ4, Φ6 Φ4, Φ6 Φ8, Φ10 Φ12	B: Meter-in  Handle marking "B" Free flow Controlled flow	Blank: Gray D: Black	Release button: Gray Body: Gray Release button: Black Body: Black	

### Specification

<b>Operating pressure range</b>	<b>0~10kgf/cm<sup>2</sup>(0~1.0MPa)</b>
Negative pressure	-750mmHg(10Torr)
Proof pressure	1.5MPa
Ambient and fluid temperature (°C)	-20~70
Applicable tubing	Soft nylon or polyurethane
Color	Gray/black

### Product feature

1. The silencer is small size, and light weight with small installation space.
2. Excellent flow characteristics, high sensitivity and easy to adjust.
3. The silencer brass body adopts a special nickel-plating process, which has good corrosion resistance and anti-pollution property.
4. Anti-drop structure is designed on the regulating rod.
5. The sealant being coated on threaded portion can ensure no leakage of the threaded connection part.
6. The inserting direction of universal speed controller can be adjusted in 360°.

### Symbol

Meter-out (A)



Meter-in (B)



### Table for interface port and tube O.D.

Product series	Thread type	Port size				
		Φ4	Φ6	Φ8	Φ10	Φ12
PSL	M5	●	●			
	1/8"	●	●	●		
	1/4"		●	●	●	
	3/8"		●	●	●	●
	1/2"			●	●	●
PSS	1/8"		●	●		
	1/4"		●	●	●	
	3/8"				●	●
	1/2"					●

### Inner structure

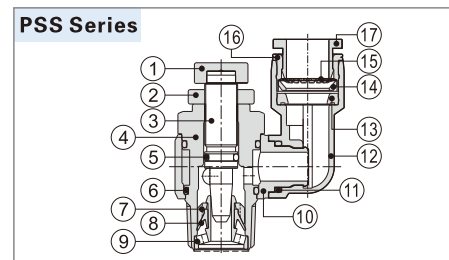
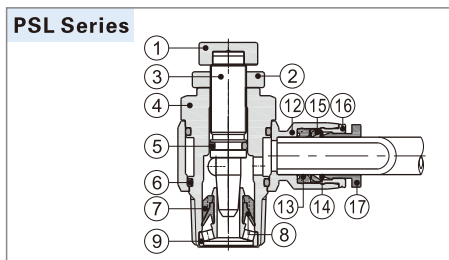

NO.	Name	Material	NO.	Name	Material	NO.	Name	Material
1	Adjusting cap	Aluminum alloy	7	Holder	PBT	13	O-ring	NBR
2	Locking cap	Aluminum alloy	8	O-ring	NBR	14	Locating seat	POM
3	Throttling column	Brass	9	Throttling sleeve	Aluminum alloy/Brass	15	Spring gasket	Stainless steel
4	Throttling body	Brass	10	Plastic body	PBT	16	Locating ring	Aluminum alloy
5	O-ring	NBR	11	O-ring	NBR	17	Plastic interface	POM
6	O-ring	NBR	12	Plastic body	PBT			

## PSL, PSS series

### Dimensions

#### PSL Series

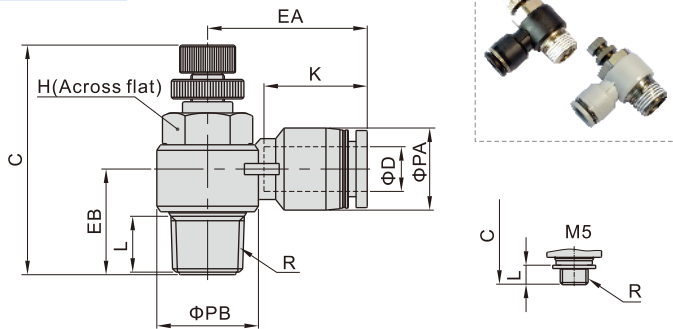

Model\Item [Note1]	ΦD	R	ΦPA	ΦPB	L	C		K	EA	EB	H	Weight (g)	PCS/bag
						max	min						
PSL4M5□	4	M5×0.8	9	10	3.5	30	27.5	14	19	9.5	8	6.5	2
PSL401□		PT1/8	9	14	7.5	41.5	35	14	20.5	15	11	16.5	2
PSL6M5□	6	M5×0.8	12.5	10	3.5	30	27.5	16.5	23.5	11.5	8	8	2
PSL601□		PT1/8	12.5	14	7.5	41.5	35	16.5	23	15.5	11	17.5	2
PSL602□	6	PT1/4	12.5	18	10	47.5	41	16.5	25	18	14	32	2
PSL603□		PT3/8	12.5	22.5	11	52.5	45.5	16.5	27	20	19	59.5	2
PSL801□	8	PT1/8	15	14	7.5	41.5	35	18.5	26.5	16.5	11	18	2
PSL802□		PT1/4	15	18	10	47.5	41	18.5	28.5	19	14	33	2
PSL803□	8	PT3/8	15	22.5	11	52.5	45.5	18.5	29.5	20	19	60	2
PSL804□		PT1/2	15	28	14	58.5	51.5	18.5	32	25	24	96.5	2
PSL1002□	10	PT1/4	18	18	10	47.5	41	21	31	20.5	14	34.5	2
PSL1003□		PT3/8	18	22.5	11	52.5	45.5	21	33	21.5	19	62	2
PSL1004□	10	PT1/2	18	28	14	58.5	51.5	21	35.5	25.5	24	98	2
PSL1203□		PT3/8	21	22.5	11	52.5	45.5	23	36	23.5	19	64	2
PSL1204□	12	PT1/2	21	28	14	58.5	51.5	23	38	27	24	100	2

[Note1] "□" stands for A or B. A indicates meter-out type while B indicates meter-in type. The two types are with the same overall dimension.

#### PSS Series

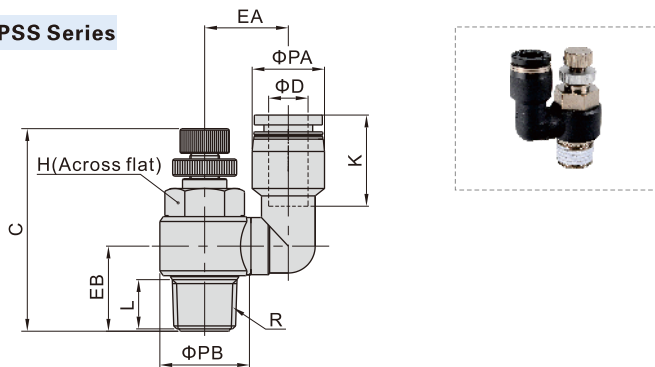

Model\Item [Note1]	ΦD	R	ΦPA	ΦPB	L	C		K	EA	EB	H	Weight (g)	PCS/bag
						max	min						
PSS601□	6	PT1/8	12.5	14	7.5	41.5	35	17	17	15	11	19	2
PSS602□		PT1/4	12.5	18	10	47.5	41	17	19	17.5	14	34.7	2
PSS801□	8	PT1/8	15	14	7.5	41.5	35	18.5	17	15	11	20.2	2
PSS802□		PT1/4	15	18	10	47.5	41	18.5	19	17.5	14	39.8	2
PSS1002□	10	PT1/4	18	18	10	47.5	41	21	20.5	17.5	14	37.2	2
PSS1003□		PT3/8	18	22.5	11	52.5	45.5	21	24	20	19	66	2
PSS1203□	12	PT3/8	21	22.5	11	52.5	45.5	23	25.5	20	19	69.2	2
PSS1204□		PT1/2	21	28	14	58.5	51.5	23	28	25	24	105.8	2

[Note1] "□" stands for A or B. A indicates meter-out type while B indicates meter-in type. The two types are with the same overall dimension.

### Flowrate characteristic

#### Controlled flow rate

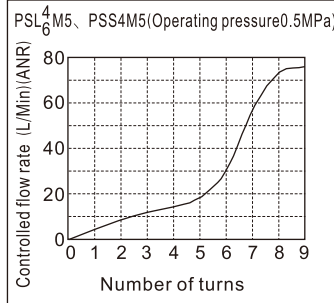

#### Free flow rate

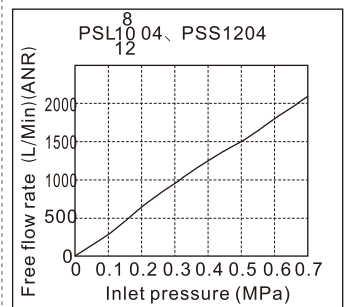
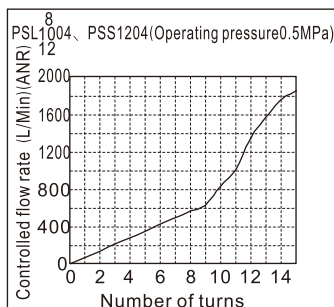
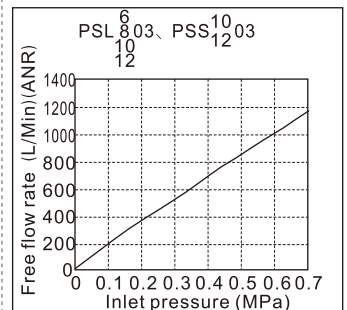
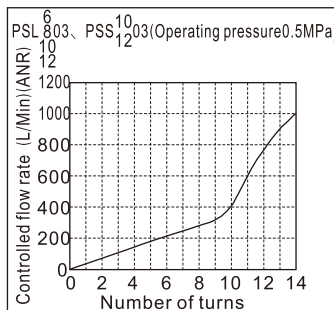
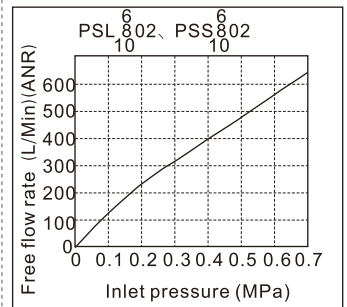
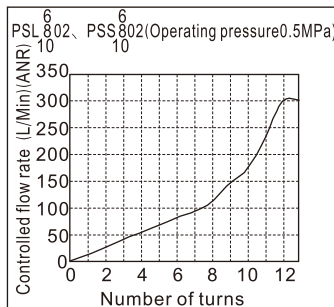
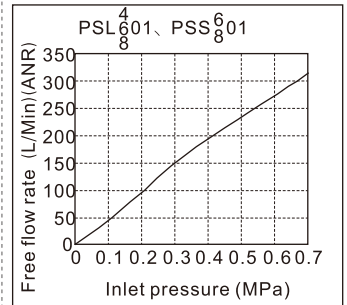
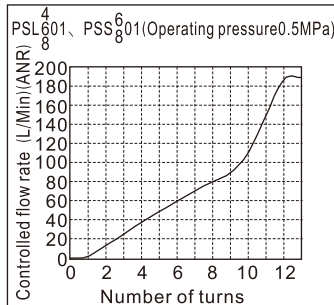
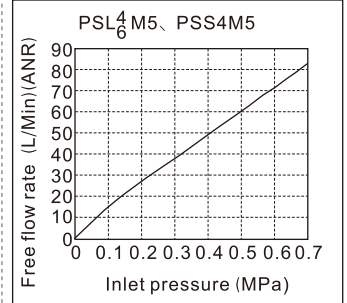



### Selection, Installation and Operation

#### Selection

- The speed controller has meter-out type and meter-in type:

	Working principle	Product identification
<p>Controlled flow Free flow</p>	<b>A: Meter-out</b> 1. The air flow is controlled from the threaded end to tubing connection end. 2. The air flow is free from the tubing connection end to the threaded end.	Handle marking "A" 
<p>Free flow Controlled flow</p>	<b>B: Meter-in</b> 1. The air flow is free from the threaded end to tubing connection end. 2. The air flow is controlled from the tubing connection end to the threaded end.	Handle marking "B" 

- Select the different control method according to the actual requirement. The meter-out type is the first priority.

- 2.1. The application example of the meter-out speed controller
- 2.2. The application example of the meter-in speed controller



#### Installation

- Installation and removal of tubing:

- 1.1. Installation of tubing

Grasp the tubing and slowly push it into the fitting until it comes to a stop. The tubing will be locked by the spring gasket.

- 1.2. Removal of tubing

Push the release button to open the spring gasket so that the tubing can be released.

Note: When remove the tubing, make sure the pressure in the tubing is Zero.

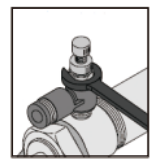
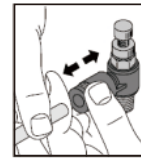
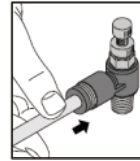

2. Mounting of the speed controller

Mount the speed controller into the inlet and outlet port of the cylinder with a wrench.

Note: Please refer to the fittings for the tightening torque and thread screw-in depth.

#### Operation

- Adjustment of the cylinder speed

- 1.1. Make sure the speed controller is turned off before applying air pressure. The cylinder may fly out due to the high speed if the air is inlet when the speed controller is turned on.
- 1.2. Adjust the speed by opening the needle slowly from the fully closed state. When a needle valve is turned clockwise, the air flow through is reduced and the actuator speed decreases. When a needle valve is turned counter-clockwise, the air flow through is increased and the actuator speed increases.

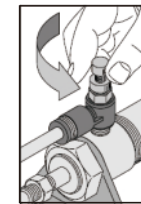
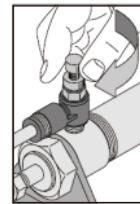

2. Operation of the speed controller

- 2.1. Do not use tools such as pliers to rotate the handle. Do not apply excessive force or shock when the needle is at the place of top or bottom. It can cause damage or air leakage.
- 2.2. A certain amount of leakage is allowed in the closed state of the speed controller. It is not designed for the use as stop valve with zero air leakage.

## PTL Mini series

### Ordering code

PTL 6 01 A □ □ -M

① ② ③ ④ ⑤ ⑥ ⑦

① Model	② Port size	③ Thread connection	④ Control method	⑤ Standard color	⑥ Thread type	⑦ Style
PTL: Speed controller (Push lock) 	4: Φ4mm 6: Φ6mm	01: 1/8"	A: Meter-out 	Standard color   Specification Blank: Gray   Release button: Gray Body: Gray	Blank: PT	M: Mini type
			B: Meter-in 	D: Black   Release button: Black Body: Black		

### Specification

<b>Operating pressure range</b>	<b>0~10kgf/cm<sup>2</sup>(0~1.0MPa)</b>
Negative pressure	-750mmHg(10Torr)
Proof pressure	1.5MPa
Ambient and fluid temperature (°C)	-20~70
Applicable tubing	Soft nylon or polyurethane
Color	Gray/black

### Symbol



### Selection, Installation and Operation

- The rotation torque of the push-lock speed controller cap should not be too large to avoid damage. It is recommended to use the torque below.

Thread size	Recommended torque(N.m)
1/8"	0.08

- Push-lock speed controller installation instructions is the same as general one. Please refer to general type for specific content.

### Dimensions

#### PTL Mini series

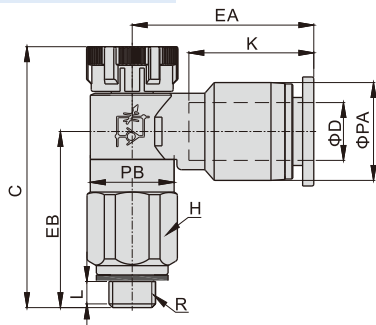

Model/Item [Note1]	ΦD	R	ΦPA	ΦPB	L	C		K	EA	EB	H	Weight (g)	PCS/bag
						Pull	Push						
PTL401□-M	4	PT1/8	8.5	9	3.5	29.5	28	12.5	16.5	19	10	11	2
PTL601□-M	6	PT1/8	10.5	9	3.5	29.5	28	13.5	19.5	19	10	12	2

[Note1] "□" stands for A or B. A indicates meter-out type while B indicates meter-in type. The two types are with the same overall dimension.

## PTL series

### Ordering code

PTL 6 01 A

① ② ③ ④ ⑤ ⑥

① Model	② Port size	③ Thread connection	④ Control method	⑤ Standard color	⑥ Thread type
PTL: Speed controller (Push lock) 	6: Φ6mm	01: 1/8" 02: 1/4" 03: 3/8"	A: Meter-out  Handle marking "A" Controlled flow Free flow	Standard color	Blank: PT
	8: Φ8mm	01: 1/8" 03: 3/8" 02: 1/4" 04: 1/2"		B: Meter-in  Handle marking "B" Free flow Controlled flow	
	10: Φ10mm	02: 1/4" 03: 3/8" 04: 1/2"	D: Black		
	12: Φ12mm	03: 3/8" 04: 1/2"		Release button: Black Body: Black	

### Specification

<b>Operating pressure range</b>	<b>0~10kgf/cm<sup>2</sup>(0~1.0MPa)</b>
Negative pressure	-750mmHg(10Torr)
Proof pressure	1.5MPa
Ambient and fluid temperature (°C)	-20~70
Applicable tubing	Soft nylon or polyurethane
Color	Gray/black

### Product feature

1. Compare with standard speed controller, smaller size, lighter weight, suitable for more occasions.
2. Effectively control the action speed and the pressure signal transmission from pneumatic device.
3. Simple push-lock, operation.
4. Adjust quickly, easily and accurately.
5. Excellent flow rate characteristic, high sensitivity and easy to adjust.
6. Options of Meter-out and meter-in, applicable for every type actuator.
7. Effectively prevent from corrosion and pollution by nickel plated copper.
8. The sealant being coated on threaded portion can ensure no leakage of the threaded connection part.

### Symbol



### Table for interface port and tube O.D.

Product series	Thread type	Port size			
		Φ6	Φ8	Φ10	Φ12
PTL	1/8"	●	●		
	1/4"	●	●	●	
	3/8"	●	●	●	●
	1/2"		●	●	●

### Selection, Installation and Operation

1. The rotation torque of the push-lock speed controller cap should not be too large to avoid damage.  
It is recommended to use the torque below.

Thread size	Recommended torque(N.m)
1/8"	0.08
1/4"	0.16
3/8"	0.24
1/2"	0.32

2. Push-lock speed controller installation instructions is the same as general one. Please refer to general type for specific content.

### Inner structure

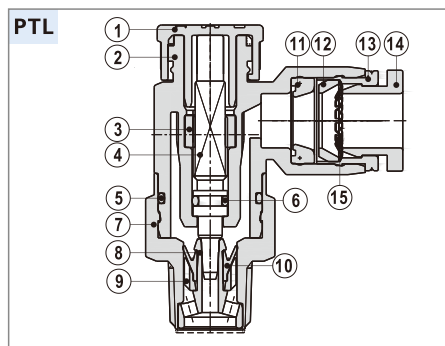

NO.	Name	Material	NO.	Name	Material
1	Adjusting cap	POM	9	Holder	PBT
2	Plastic body	PBT	10	O-ring	NBR
3	Locating ring	Aluminum alloy	11	O-ring	NBR
4	Throttling column	Aluminum alloy	12	Locating seat	POM
5	O-ring	NBR	13	Locating ring	Aluminum alloy
6	O-ring	NBR	14	Plastic interface	POM
7	Throttling body	Brass	15	Spring gasket	Stainless steel
8	Throttling sleeve	Aluminum alloy			

## PTL series

### Dimensions

#### PTL Series

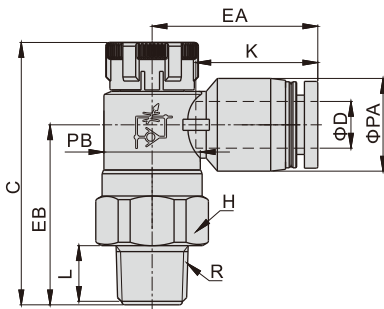

Model\Item [Note1]	ΦD	R	ΦPA	ΦPB	L	C		K	EA	EB	H	Weight (g)	PCS/bag
						Pull	Push						
PTL601□	6	PT1/8	12.5	13	8.5	36	34.5	16.5	22.5	23.5	14	12.5	2
PTL602□		PT1/4	12.5	16.5	11	40.5	39	16.5	24	28	17	19.5	2
PTL603□		PT3/8	12.5	19	12	44	42.5	16.5	25.5	31	19	28.5	2
PTL801□	8	PT1/8	15	13	8.5	36	34.5	18.5	24.5	22.5	14	13	2
PTL802□		PT1/4	15	16.5	11	40.5	39	18.5	26	27	17	20.5	2
PTL803□		PT3/8	15	19	12	44	42.5	18.5	27	30	19	29	2
PTL804□	PT1/2	15	24	15	52.5	51	18.5	29.5	37.5	24	49	2	
PTL1002□	10	PT1/4	18	16.5	11	40.5	39	21	31	26	17	22	2
PTL1003□		PT3/8	18	19	12	44	42.5	21	29	29	19	30.5	2
PTL1004□		PT1/2	18	24	15	52.5	51	21	31.5	36.5	24	50.5	2
PTL1203□	12	PT3/8	21	19	12	44	42.5	23	34.5	28	19	32.5	2
PTL1204□		PT1/2	21	24	15	52.5	51	23	34	36	24	53	2

[Note1] "□" stands for A or B. A indicates meter-out type while B indicates meter-in type. The two types are with the same overall dimension.

### Flowrate characteristic

#### Controlled flow rate

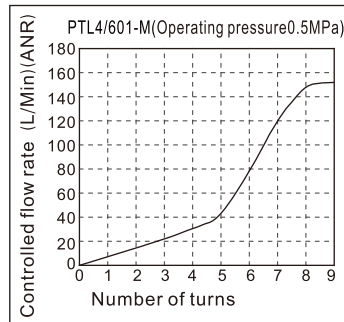

#### Free flow rate

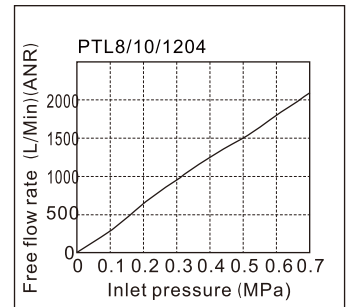
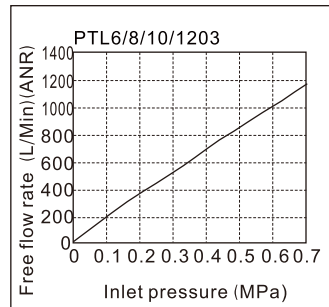
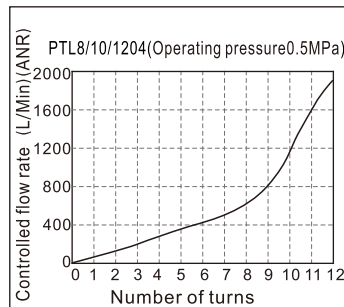
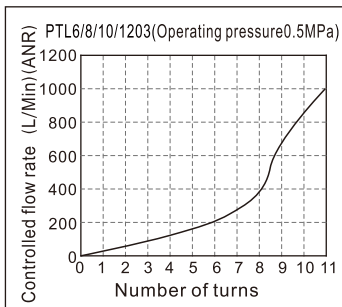
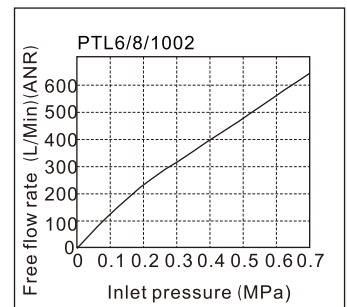
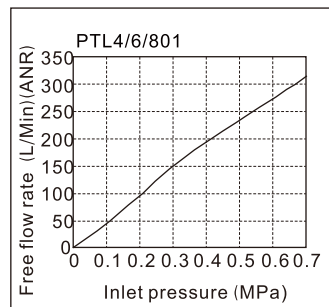
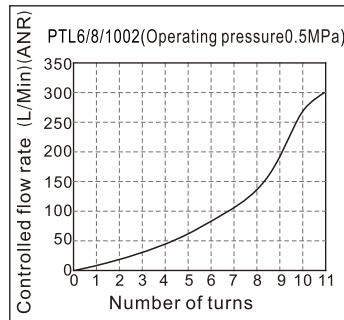
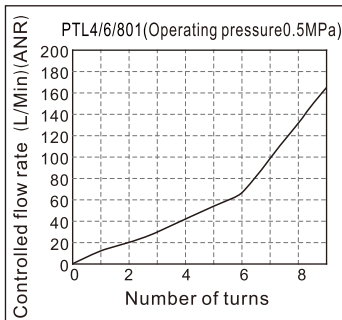
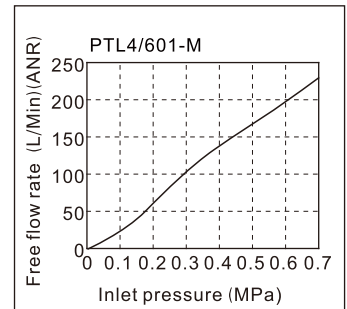

## European Branch Office



Name: ATC (Italia) S.R.L.  
 Add: Via Manzoni 20, 20020 Magnago (MI), Italy  
 Tel: +39-0331-307204  
 Fax: +39-0331-307208  
 Zip code: 20020

## Headquarter, Sales Companies and Production Bases



Name: AirTAC International Group Taiwan Branch (CayMan)  
 Office: 4F., No.129, Sec.3, Minsheng E. Rd., Songshan Dist., Taipei City 10596, Taiwan  
 Tel: +886-2-2719-7538  
 Fax: +886-2-2719-7539  
 Zip code: 10596  
 Factory: No.28, Kanxi Rd., Xinshi Dist., Tainan City 74148, Taiwan  
 Tel: +886-6-5896-889  
 Fax: +886-6-5898-589  
 Zip code: 74148



Name: Ningbo AirTAC Automatic Industrial Co., Ltd.  
 Add: No.88, Siming E. Rd., High Tech Area of Fenghua City, Zhejiang, China  
 Tel: +86-574-8895-0001  
 Fax: +86-574-8895-0066  
 Zip code: 315500



Name: Guangdong AirTAC Automatic Industrial Co., Ltd.  
 Add: No. 7, Kaixuan Rd., Songxia Industrial Park, Shishan Town, Nanhai District, Foshan, Guangdong, China  
 Tel: +86-757-8521-7188  
 Fax: +86-757-8521-7841  
 Zip code: 528234



Name: AIRTAC INTERNATIONAL (SINGAPORE) PTE LTD  
 Add: 12 Gul Drive, Singapore 629463  
 Tel: +65-6933-7676  
 Fax: +65-6863-9030  
 Zip code: 629463



Name: AirTAC USA Corporation  
 Add: 21201 Park Row Drive, Katy, Texas, 77449, USA  
 Tel: +1-281-394-7177  
 Fax: +1-281-394-7199



Name: Airtac Co., Ltd.  
 Add: 3-6-3, Kusune, Higashiosaka-shi, Osaka, Japan  
 Tel: +81-6-4307-6039  
 Fax: +81-6-4307-6038  
 Zip code: 577-0006



Johor: No 20, Jalan Tiong Emas 1, Kawasan Perindustrian Tiong Nam, 81100 Johor Bahru, Johor.  
 Tel no.: +607-358 7969 Fax no.: +607-358 7971  
 Selangor: Lot 5019, Jalan Pendamar 27/90, Section 27, 40400 Shah Alam, Selangor, Malaysia  
 Tel no.: +603-56140592 Fax no.: +603-56140912  
 Penang: No 2, Lorong Saga Jaya 5, Taman Perindustrian Saga Jaya, 13600 Perai, Penang.  
 Tel no: +604-386 6845 Fax no: +604- 384 2671  
 Email address: sales\_my@airtac.com



Name: AirTAC Industrial Co., Ltd.  
 Add: 11/12 M00 9, Bangchalong, Bangplee, Samut Prakan, Thailand  
 Tel: +66-2-023-3515  
 Fax: +66-2-023-3518  
 Zip code: 10540

BIBUS SK, s.r.o  
 Trnavská 31, SK-94 901 Nitra  
 Tel.: 037/ 7777 911 Email: sale@bibus.sk  
 Fax.: 037/ 7777 999 http://www.bibus.sk